

Catalogue

Fixing Systems



fischer  [®]
innovative solutions



Dear partners,

For more than 70 years, our fischer group of companies has stood for safe and economical connections in construction. Innovative strength and technological competence strengthen our position as one of the world's leading fixing specialists in the market. New developments in the building materials industry, increasing demands on dimensioning and advancing digitalisation are changing the demands on fixing technology. As market shapers, we provide you with the best and most economical solution for your fastening project.

We attach high value to the safety, quality and ease of use of our products. Our large product range includes chemical systems, steel anchors and plastic plugs. We are also broadly positioned in the areas of screws, drills, adhesives, sealants and foams. Assortments specially tailored to specific applications, such as façade and thermal insulation composite systems, or sanitary, heating, ventilation and electrical installation complete the range.

Our field staff and application engineers ensure optimal support. In addition, we work closely with our own national subsidiaries and sales partners around the world. With our modular design software FIXPERIENCE as well as data for various software applications (BIM, 3D), we support the planning of projects that guarantee the required verification based on valid standards. In addition, we offer digital services such as plug finder apps for end users and professionals.

Our broad training program keeps you up to date on the latest fixing solutions and regulations. The seminars take place in our own fischer academy, in the more than 70 Competence Centers nationwide, directly at the customer's premises and via webinars. In addition, our fischer TourTruck travels as a mobile training and exhibition center in Germany and abroad.

We hope you enjoy discovering and using our products.



Marc-Sven Mengis
Chairman of the Management Board of the fischer group of companies

A brand and its promise to perform

„Whoever chooses fischer receives more than a range of safe products. The aim is to always develop the best solutions for our customers across the globe.“

Besides the innovative products, this predominantly concerns support that is focused on the customer, and services designed to improve customer benefit.



Continious improvement

With the fischer ProcessSystem (FPS), we ensure that we are adapting and optimising our processes in line with customer requirements in a flexible manner and on a continuous basis. Thus we are glad having been awarded with the 1. place “Excellence in Operations” within the challenging contest “Factory of the Year”.



Award 2016
Excellence in Operations

Always with its finger on the pulse of the times

At fischer, innovation is more than just a sum of the patents. We are open to new things and are prepared for change – always with the aim of offering our customers the greatest possible benefits. Over the years, our own development and production sites have been developing numerous fixing solutions for the most wide-ranging applications.

Be it new production procedures or materials, such as renewable raw materials: We are carrying out the research for your safety and will continue to do so in the future. This gives us such great flexibility that we can even develop tailor-made customer solutions. This power to innovate has seen fischer become market leader in anchor technology and the fixing industry.

Safety that connects – Decisive quality

We don't make any compromises when it comes to the safety of our products. A whole host of our products are distinguished by comprehensive, up-to-date and international approvals. The fischer product range is well-positioned in all sectors of fixing technology – Steel, Nylon and Chemical fixings. In award-winning quality which continues to impress both professional clients and private customers with equal measure.



See ICC-ES Evaluation Report at www.icc-es.org



International approvals characterise many of our products





We take responsibility

Our active environment management policy means that we are helping to maintain an intact environment for our generation and for those that follow. The environment management policy at the Tumlingen site has been certified in line with DIN EN ISO 14001.

We are a member of the German Sustainable Building Council (DGNB), and our products have been successively certified in line with the guidelines provided by the Institute for Construction and the Environment (IBU). With our greenline products, we have introduced the first fixing assortment in the market, based on over 50% of regrowing raw materials.



Our service to you

We are a reliable partner, one that will stand at your side and address your individual requirements with advice and action:

- Our products range from **chemical systems to steel anchors** through to **plastic anchors**.
- **Competence and innovation** through own research, development and production.
- **Global presence** and active sales service in over 100 countries.
- **Qualified technical consulting** for economical and compliant fastening solutions. Also on-site at the construction site requested.
- **Training sessions**, some with accreditation, at your premises or at the fischer academy.
- **Design and construction software** for demanding applications.



fischer 360°-Service



01 fischer DUO-Line assortment

Clever combinations for more power and intelligence.

Page 406 Page 348 Page 394

02 fischer FIS EM Plus

The powerful injection mortar for rebar connections and cracked concrete.

Page 86

03 fischer bolt anchor FAZ II

For highest demands. Powerful and flexible.

Page 202

04 fischer ULTRACUT FBS II 8, 10 and 12 A4 stainless steel

The powerful concrete screw for top installation comfort in external areas.

Page 232

05 fischer ULTRACUT FBS II 6 zinc-plated steel

The high-performance concrete screw for absolute installation ease.

Page 242







06 fischer hollow drill bit FHD

Hollow drill bit for drilling with low dust as well as for efficient and approved anchoring.







Page 561





Selection guide of products and applications	8	1
greenline	23	2
Chemical fixings	47	3
High performance steel anchors	201	4
Frame fixings / Stand-off installation	293	5
General fixings	347	6
Cavity fixings	393	7
Electrical fixings	415	8
Sanitary fixings	455	9
Scaffold and eye screw fixings	465	10
Insulation fixings / Façade fixings	475	11
Foams and sealants	501	12
Adhesives	541	13
Drills and bits	549	14
Basic knowledge	572	15
Services	592	16

2 greenline









		Page
Universal plug UX GREEN		26
Expansion plug SX GREEN		28
Plasterboard fixing GK GREEN		30
Hammerfix N GREEN		32
Aircrete anchor GB GREEN		34
Insulation fixing FID GREEN		36
Injection mortar FIS GREEN		38











3 Chemical fixings

		Page
MORTARS AND CAPSULES FOR GENERAL APPLICATIONS		
Introduction		48
Highbond-System FHB II		52
Highbond-System FHB II Inject		59
Superbond-System FSB		64
Resin anchor RM II		79
Epoxy mortar FIS EM Plus		86
Epoxy mortar FIS EB		95
Injection mortar FIS V		101





















		Page
Injection mortar FIS VL		117
Injection mortar FIS GREEN		126
Injection mortar FIS P Plus		133
Injection mortar FIS P		140

ANCHOR RODS

Introduction		144
Threaded rod FIS A		146
Threaded rod RG M		154
Internal threaded anchor RG M I		159
Internal threaded anchor FIS E		161
Accessories for push-trough installation		164
Anchor sleeve FIS H K		167
Anchor sleeve FIS H L		167
Anchor sleeve FIS H N		167

	Page
SPECIAL APPLICATIONS	
Introduction	169
Highbond anchor dynamic FHB dyn 	170
Dynamic-Anchor FDA 	174
UMV multicone dynamic bonded anchor 	176
Rebar connections 	179
Concrete-Concrete Shear Connector FCC 	185
Remedial wall tie VBS 8 	187
Weather facing reconstruction system FWS II 	189
Can System FCS 	191
Fill & Fix injection fixing 	193
DISPENSERS 	196
ACCESSORIES 	198





















4 High performance steel anchors

	Page
Bolt anchor FAZ II 	202
High performance anchor FH II 	209
High performance anchor FH II-I 	217
ZYKON undercut anchor FZA 	220
ZYKON hammer set anchor FZEA II 	228
Concrete screw ULTRACUT FBS II 8-14 	232
Concrete screw ULTRACUT FBS II 6 	242
Hammerset anchor EA II 	247
Hammerset anchor EA-N 	252
Nail anchor FNA II 	256
Nail anchor FNA II RB 	260
Ceiling nail FDN II 	263
Ceiling nail FDZ 	265
Bolt anchor FBN II 	267
Heavy-duty anchor TA M 	272
Heavy-duty anchor TA M-T 	276
Sleeve anchor FSA 	278
Fixing set for Diamond Drills FDBB 	281
Wall screw MR 	283
Hollow-ceiling anchor FHY 	285
Aircrete anchor FPX-I 	288









5 Frame fixings / Stand-off installation

		Page
Frame fixing SXRL		294
Frame fixing SXR		300
Frame fixing FUR		306
Anti-corrosion spray FTC-CP		310
Hammerfix N		311
Hammerfix N GREEN		315
Nail sleeve FNH		317
Window frame fixing F-S		319
Metal frame fixing F-M		321
Window frame screws FFSZ and FFS		324
Wall tie VB		328
Adjustable fixing S10J		329
Adjustable screw JUSS		331
Spacing screw ASL		332
Stand-off installation Thermax 8 / 10		334
Stand-off installation Thermax 12 / 16		337
Remedial wall tie mechanical VBS-M		343









6 General fixings











		Page
DUOPOWER		348
Universal plug UX		351
Universal plug UX GREEN		356
Expansion plug SX		358
Expansion plug SX GREEN		361
Expansion plug S		363
Threaded rod plug RODFORCE FGD		366
Metal expansion anchor FMD		368
Expansion plug M-S		370
Anchor M		372
Brass fixing MS		374
Aircrete anchor GB		376
Aircrete anchor GB GREEN		378
Turbo aircrete anchor FTP K		380
Turbo aircrete anchor FTP M		382
Brass fixing PA 4		384
Balcony cladding fixing P 9 K		386
Stair-tread fixing TB / TBB		388
Repair pad FIX.it		389
Doorstop TS		390



7 Cavity fixings

		Page
Nylon toggle DUOTEC		394
Metal cavity fixing HM		397
Gravity- and spring-toggle K, KD, KDH, KM		400
Board fixing PD		404
Plasterboard fixing DUOBLADE		406
Plasterboard fixing GK		408
Plasterboard fixing GK GREEN		410
Plasterboard fixing metal GKM		412



8 Electrical fixings

		Page
Locking clip SCN		416
Pipe clip RC		418
Pipe clip FC		420
Saddle clip SCH		422
Fastening tie FF		424
ClipFix plus LS/ES/ZS		426
ClipFix plus SD		428
Cable clasp KB		430





		Page
Cable harness SHA		432
Multi cable support metal SHA M		434
Wall slot clip FWSC		436
Nail disc NSB		437
Nail clip NS/MNS		439
Spacer pipe clamp AM		441
Conduit clip BSM		443
Textile web strapping GWB		445
Perforated steel banding LBV / LBK		446
Impact nail ED		447

Cable tie BN/UBN		449
Cable tie plug FCTP		451
Wireclip		452













9 Sanitary fixings

		Page
Sanitary fixings for board materials		456
Ceramic fixings		458
Wash basin and urinal fixings		460



















10 Scaffold and eye screw fixings

















		Page
Scaffold anchoring GS 12 + plug		466
Scaffold anchoring FI G		468
Eye screw GS		470
Ring nut RI		472

11 Insulation fixings / Façade fixings





		Page
Insulation support DHK		476
Insulation support DHM		478
Render fixing DIPK		480
Render fixing FIF-PN 8		482
Render fixing FIF-CN II 8		485
Render fixing FIF-CS 8		488
Insulation discs		490
Retaining disc with screw DHT S		492
Insulation fixing FID		494
Insulation fixing FID GREEN		496
Holding clamp DVN		498
Fibre cement panel screw FAFZ H		499

12 Foams, sealants













		Page
One-component gun foam PUP S 750		502
One-component premium gun foam PUP 750		503
One-component maxi gun foam PUP S 500		504
One-component premium gun foam compact PUP 500		505
One-component premium gun foam PUP 750 B3		506
One-component premium gun foam PUP BS 750		507
One-component premium B1 gun foam PUP B1 750		508
One-component premium adhesive foam PUP ETICS 750		509
One-component premium perimeter adhesive foam PUP P 750		510
One-component rapid installation foam PU S 500/750		511
One-component premium rapid installation foam PU 500/750		512
2-component premium rapid foam 2K PU 400		513
Accessories		514
Premium sanitary silicone DSSA		516
Sanitary silicone DSSI		517
Multi-silicone DMS		518
Premium high temperature silicone DHS		519
Premium construction silicone DBSA		520
Roof and wall silicone DBSI		521

	Page		Page
Premium silicone for natural stone DNS	 522	All-round adhesive gluing and sealing KD	 544
Premium B1 silicone DFS	 523	All-round Adhesive Gluing and Sealing KD transparent	 545
Construction sealant Premium DKM	 524	Flexible power adhesive Premium HTM	 546
Façade acrylic Premium DFA	 525		
Premium painting acrylic DMA	 526		
Premium structured acrylic DSA	 527		
Acrylic sealant DA	 528		
Repair mortar DEC	 529		
Premium all-weather sealant DDK	 530		
Roof sealing compound DD	 531		
Accessories for sealants	 532		
Sealant selection matrix	534		
Zinc spray FTC-ZS	 536		
Zinc spray bright grade FTC-ZB	 537		
Zinc-alu spray FTC-ZA	 538		

13 Adhesives

	Page		Page
Assembly adhesive MK	 542	Bit-Set	 569
Power Adhesive Express KK	 543	Accessories for impact driver	 570

14 Drills and bits

	Page
Hammer drill bit Quattric II	 550
Hammer drill bit SDS Plus II Pointer	 553
Masonry drill bit Pointer M	 557
Hammer drill bit SDS Max II / SDS Max IV	 558
Hollow drill bit FHD	 561
Stone drill bit D-S	 562
Premium chisel FCP	 563
Standard chisel	 564
Profi-bit FPB	 565
Diamond-bit FDB	 566
Maxx-bit FMB	 567
Bit holder FBH	 568
Accessories for impact driver	



Non-cracked concrete

			Single fixings for non-cracked concrete		
			Chemical systems		
Product	Type		Epoxi mortar-system FIS EM Plus	Superbond-System FSB	Injection mortar FIS V
	Page		86	64	113
	Image				
Connection thread or Screw diameter	Anchor rod or anchor size		M8 - M30	M8 - M30	M6 - M30
	Internal thread		M8 - M20	M8 - M20	M8 - M20
	Reinforcing bar		Ø 8 - 40 mm	Ø 8 - 32 mm	Ø 8 - 28 mm
	Screw diameter				
Steel/material	gvz		•	•	•
	A4		•	•	•
	C		•	•	•
	Nylon				
Usable length	up to		∞	∞	∞
Approvals / Certificates	Approvals	ETA	•	•	•
		ICC	•	•	•
		DIBt			
		Seismic	•	•	•
		Dynamic			
	Certificates	Shock			
	Fire resistance reports	•	•	•	
Type of installation	Pre-positioned installation		•	•	•
	Push-through installation		•	•	•
	Stand-off installation		•	•	•
Drilling method	Hammer drilling		•	•	•
	Hollow drilling		•	•	•
	Diamod-drilling		•	•	
Waiting time until loading at 20 °C	none				
	short	< 5 Minutes			
	middle	≤ 20 Minutes		•	•
	long	> 20 Minutes	•	•	•
Substrate			+5 °C	-30 °C	-10 °C
Special features	approved without borehole cleaning				
	Installation in concrete < C20/25 acc. certificate				
	Installation in concrete > C50/60 acc. certificate				
	approved in water-filled drill holes		•	•	
	Installation in steel fibre concrete possible		•	•	•
	Installation possible in narrow members ≤ 120 mm		•	•	•
	removable	flush with the surface	•*	•*	•*
		completely			







* With internal threaded anchor



Cracked concrete

			Single fixings for cracked concrete		
			Chemical systems		
Product	Type		Highbond-System FHB II	Superbond-System FSB	Injection mortar FIS V
	Page		52	64	113
	Image				
Connection thread or Screw diameter	Anchor rod or anchor size		M8 - M24	M8 - M30	M10 - M30
	Internal thread			M 8 - M 20	
	Reinforcing bar			Ø 8 - 32 mm	Ø 10 - 28 mm
	Screw diameter				
Steel/material	gvz		•	•	•
	A4		•	•	•
	C		•	•	•
	Nylon				
Usable length	up to		165 mm	∞	∞
Approvals / Certificates	Approvals	ETA	•	•	•
		ICC		•	•
		DiBt			
		Seismic		•	•
		Dynamic			
	Certificates	Shock	•		
	Fire resistance reports	•	•	•	
Type of installation	Pre-positioned installation		•	•	•
	Push-through installation		•	•	•
	Stand-off installation		•	•	•
Drilling method	Hammer drilling		•	•	•
	Hollow drilling		•	•	•
	Diamond-drilling			•	
Waiting time until loading at 20 °C	none				
	short	< 5 Minutes	•		
	middle	≤ 20 Minutes	•	•	•
	long	> 20 Minutes		•	•
Substrate			-5 °C	-30 °C	-10 °C
Special features	approved without drill-hole cleaning		•		
	Installation in concrete < C20/25 acc. certificate		•	•	•
	Installation in concrete > C50/60 acc. certificate		•	•	•
	approved in water-filled drill holes		•	•	
	Installation in steel fibre concrete possible		•	•	•
	Installation possible in narrow members ≤ 120 mm		•	•	•
	removable	flush with the surface		•*	
		completely			

* With internal threaded anchor







Single fixings for cracked concrete				Redundant fixtures (multiple fixtures)		
Steel anchors			Frame fixings	Steel anchors		Frame fixings
Bolt anchor FAZ II	Concrete Screw FBS II	High performance anchor FH II	SXRL 10	Nail anchor FNA II	Drop-in anchor EA II	SXR / SXRL
202	232	209	294	256	247	294
						
M8 - M24	Ø 6 - 14 mm	Ø 10 - 32 mm	Ø 10 mm	Ø 6 mm M6 - M8		Ø 8 - 14 mm
		M6 - M12			M6 - M12	
			7 mm			Ø 5 - 10 mm
•	•	•	•	•	•	•
•	•	•	•	•	•	•
•				•		•
300 mm	205 mm	100 mm	220 mm	120 mm	∞	290 mm
•	•	•		•	•	•
•						
•	•	•	•			•
•						
•	•	•		•	•	
•	•	•	•	•	•	
•						
•	•	•*		•	•	
•	•	•	•	•	•	•
•						
•	•	•		•	•	•
•	•	•	•	•	•	
•						
•	•	•	•	•	•	•
•	•	•				
•	•	•	•	•	•	•
•						
•	•	•*	•	•	•	•
•	•	•	•	•	•	•
-40 °C	-40 °C	-40 °C	-40 °C	-40 °C	-40 °C	-40 °C
•	•			•	•	•
•	•			•	•	•
•	•	•	•	•	•	•
•						
•	•	•	•	•	•	•
•	•	•*	•	•	•	•
•	•	•	•	•	•	•

* With internal threaded anchor

Aircrete concrete



1 Product overview by materials

			Chemical systems	Steel-anchor	Frame fixings	General fixings			
Product	Type		Injection mortar FIS V	Aircrete anchor FPX-I	SXRL	Aircrete anchor GB	DUOPOWER	Turbo aircrete anchor FTP K/M	
	Page		113	288	294	376	348	380	
	Image								
Connection thread or Screw diameter	Anchor rod or anchor size		M6 - M16		Ø 8 - 14 mm	GB 10	Ø 5 - 14 mm	Ø 4 - 10 mm	
	Internal thread		M6 - M12	M6 - M12				M6 - M10	
	Screw diameter				Ø 5 - 10 mm	Ø 5 - 10 mm	Ø 3 - 12 mm	Ø 5 - 10 mm	
Steel/material	gvz		•	•	•			•	
	A4		•		•				
	Nylon				•	•	•	•	
Usable length	up to		∞	∞	290 mm	105 mm	∞	∞	
Approvals / Certificates	Approvals	ETA	•	•	•				
		DiBt			•	•			
	Certificates	Fire resistance reports	•	•					
Type of installation	Pre-positioned installation		•	•		•	•	•	
	Push-through installation		•		•		•		
	Stand-off installation		•	•					
Drilling method	Hammer drilling		•		•				
	Rotary drilling		•	•	•	•	•	•	
Waiting time until loading at 20 °C	none			•	•	•	•	•	
	short	< 5 Minutes							
	middle	≤ 20 Minutes	•						
	long	> 20 Minutes	•						
Minimum component temperature			-10 °C	-40 °C	-40 °C	-20 °C	-40 °C	-40 °C	
Special features	approved without borehole cleaning								
	applicable in aircrete concrete ceilings			•					
	removable	flush with the surface		•*	•	•	•	•	•
		completely				•	•	•	•







* With internal threaded anchor



Solid- & perforated brick

1

Product overview by materials

			Chemical systems	Frame fixings				General fixings
Product	Type		Injection mortar FIS V	SXR	SXRL	FUR	Nail plug N	DUOPOWER
	Page		113	320	294	306	311	348
	Image							
Connection thread or Screw diameter	Anchor rod or anchor size		M6 - M16	∅ 6,8,10 mm	∅ 8 - 14 mm	∅ 10 mm	∅ 5-10 mm	∅ 5 - 14 mm
	Internal thread		M6 - M12					
	Screw diameter			∅ 6 - 7 mm	∅ 6 - 10 mm	∅ 7 mm	3,5 - 7 mm	∅ 3 - 12 mm
Steel/material	gvz		•	•	•	•	•	
	A4		•	•	•	•	in A2	
	Nylon			•	•	•	•	•
Usable length	up to		∞	210 mm	290 mm	160 mm	180 mm	∞
Approvals / Certificates	Approvals	ETA	•	•	•	•		
		DiBt			•			
	Certificates	Fire resistance reports	•					
Type of installation	Pre-positioned installation		•					•
	Push-through installation		•	•	•	•	•	•
	Stand-off installation		•					
Drilling method	Hammer drilling		•	•	•	•	•	•
	Rotary drilling		•	•	•	•	•	•
Waiting time until loading at 20 °C	none			•	•	•	•	•
	short	< 5 Minutes						
	middle	≤ 20 Minutes	•					
	long	> 20 Minutes	•					
Minimum component temperature			-10 °C	-40 °C	-40 °C	-40 °C	-40 °C	-40 °C
Special features	approved without borehole cleaning							
	removable	flush with the surface	•*	•	•	•	•	•
		completely		•	•	•	•	•







* With internal threaded anchor

Panel building materials

1



Product overview by materials



			Cavity fixings					General fixings
Product	Type		Metal cavity fixing HM	Gravity toggle/spring toggle KD	DUOTEC	Board fixing PD	Plasterboard fixing GK/GKM	DUOPOWER
	Page		397	400	394	404	408	348
	Image							
Connection thread or diameter of the screw	anchor size		M4 - M8	M3 - M10	Ø 10 and Ø 12 mm	Ø 8-12 mm		Ø 5,6,8 and 10 mm
	Screw diameter		Metric Screw M4 - M6; Hexagon-headed screw M8; Angle hook M4 and M5	Metric thread M3 - M10; Round hook M3 - M8	Metric thread M5 - M6 Chipboard screws 4,5- 6 mm	Chipboard screw 4,0-6,0 mm	Chipboard screw 4,0-5,0 mm	Chipboard screw 3,0-8,0 mm
Steel/material	gvz		•	•			•	
	A4							
	Nylon				•	•	•	•
Panel thickness			3-50 mm	9,5-90 mm	9,5-55 mm	min. 6 mm	min. 9,5 mm	min. 9,5 mm
Usable length	up to		30 mm	63 mm	∞	∞	∞	∞
required cavity depth by 12,5 mm board thickness			min. 19 mm	min. 27 mm	min. 40 mm	min. 23 mm	min. 13 mm	min. 18 mm
Type of installation	Pre-positioned installation		•	•	•	•	•	•
	Push-through installation							•
	Stand-off installation			•	•			
Drilling method	Rotary drilling		•	•	•	•	•	•
Waiting time until loading	none		•	•	•	•	•	•
Special features	removable	flush with the surface		•		•		
		completely					•	•









Insulated building materials (e.g. ETICS)

			Stand-off installation system		Insulation fixing FID
Product	Type		Thermax 12 and 16	Thermax 8 and 10	FID 50 and 90
	Page		337	334	494
	Image				
Connection thread or Screw diameter	Anchor rod or anchor size		M12 and M16	M8 and M10	
	Screw diameter			4,5 - 6 mm, M6 - M10	4,5-6 mm
Steel/material	gvz		•	•	•
	A4		•		
	Nylon			•	
Usable length	up to		∞	∞	∞
Approvals / Certificates	Approvals	ETA			
		DiBt	•		
Type of installation	Pre-positioned installation		•	•	•
	Push-through installation				
	Stand-off installation		•	•	
Drilling method	Hammer drilling		•	•	
	Rotary drilling		•		
Waiting time until loading at 20°C	none			•	•
	short	< 5 Minutes	depends on the injection mortar		
	middle	≤ 20 Minutes	depends on the injection mortar		
	long	> 20 Minutes	depends on the injection mortar		
Minimum component temperature			-10 °C	-40 °C	-40 °C
Special features	removable	flush with the surface	•	•	•
		completely			•





2 greenline

		Page
Universal plug UX GREEN		26
Expansion plug SX GREEN		28
Plasterboard fixing GK GREEN		30
Hammerfix N GREEN		32
Aircrete anchor GB GREEN		34
Insulation fixing FID GREEN		36
Injection mortar FIS GREEN		38

Environmentally friendly and secure

Sustainable building

With the introduction of its greenline products, fischer is the first manufacturer worldwide to offer a range of bio-based fixing systems.

We are adapting to the demands of processors and builders who greatly value sustainability when building and renovating, even when it comes to installation.



Grown naturally

All greenline products are produced with at least 50 % renewable raw materials. These do not compete with food and feed products or with corresponding cultivation areas. The regenerative material percentage is always confirmed by independent testing and certification by the DIN CERTCO / TÜV Rheinland.

All products are in the „BIOBASED 50 - 85 %“ class.



Durably secure

With the introduction of its greenline products, fischer is the first manufacturer worldwide to offer a range of bio-based fixing systems.

We are adapting to the demands of processors and builders who greatly value sustainability when building and renovating, even when it comes to installation.



Ecological proof of performance

The FIS GREEN has an Environmental Product Declaration from the Institute of Building and Environment (IBU) and thereby a data basis for ecological building rating.

Furthermore, it has been classified in the best possible emission class: A+ „very low emission“ for volatile substances as per the French VOC directive. Ecological advantages that also pay dividends in competition.



We take responsibility

For decades fischer has been actively practising environmental protection and taking on responsibility so that the environment remains intact for future generations.

We have an environmental management system certified according to DIN ISO 14001 and are a member of the German Sustainable Building Council (DGNB).



The first range of fixing products with renewable resources

General fixings

Universal plug UX GREEN

The nylon plug for all construction materials



Page 26

Special fixings

Expansion plug SX GREEN

The powerful nylon plug with 4-way expansion



Page 28

Chemical fixings

Injection mortar FIS GREEN 300 T

Injection mortar for high loads



Page 38

Plasterboard fixing GK GREEN

The fastest installation in gypsum plasterboard



Page 30

Hammerfix N GREEN

The hammer-in plug for simple, fast and economic installation



Page 32

Aircrete anchor GB GREEN

Secure in aerated concrete



Page 34

Insulation fixing FID GREEN



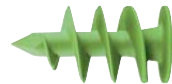











Thermal bridgefree installation in insulation materials



Page 36



The fischer greenline product line has a green solution for every building material.

									
		Concrete	Solid brick	Perforated brick	Aerated concrete	Natural stone	Panel building materials	Gypsum plasterboard	Insulation panels
UX GREEN		✓	✓	✓	✓	✓	✓	✓	
SX GREEN		✓	✓	✓	✓	✓			
GK GREEN								✓	
N GREEN		✓	✓	✓	✓	✓			
GB GREEN					✓				
FID GREEN									✓
FIS GREEN		✓	✓	✓	✓	✓			

The nylon plug for all building materials

2
greenline

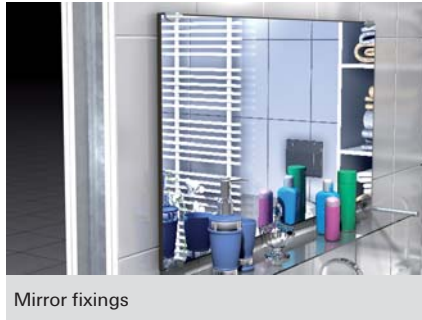

Mirror fixings



Pictures

BUILDING MATERIALS

- Concrete
- Gypsum plasterboard and gypsum fibreboards
- Vertically perforated brick
- Hollow blocks made from lightweight concrete
- Cavity floor slabs made from bricks and concrete
- Perforated sand-lime brick
- Solid sand-lime brick
- Natural stone
- Aerated concrete
- Chipboard
- Solid panel made from gypsum
- Solid brick made from lightweight concrete
- Solid brick

CERTIFICATES



ADVANTAGES

- Produced with at least 50% renewable raw materials and therefore particularly environmentally friendly.
- Just as effective, secure and durable as regular UX plugs.
- The universal operating principle (knotting or expanding) allows for use in all solid, hollow and board building materials. Thus the UX GREEN is the correct choice for unknown base materials.
- Plug collar for anti-slip safety and saw tooth sides as turning lock ensure the highest installation safety.

APPLICATIONS

- Pictures
- Lighting
- Skirting
- Light cabinets
- Towel rails
- Mirror cabinets
- Curtain rails
- Wash basin fixings
- TV consoles
- Plumbing and heating fixings

FUNCTIONING

- The Universal plug UX with rim is suitable for pre-positioned installation; the UX without rim is suitable for push-through installation.
- When screwing in the screw, the UX GREEN expands in solid building materials and knots itself into cavities.
- Suitable for wood and chipboard screws, as well as stud screws.
- The required screw length is given by: the plug length + fixture thickness + 1 x screw diameter.
- In the case of board building materials, the threadless part of the screw must not be longer than the fixture.
- The edge distance must be at least one plug length.

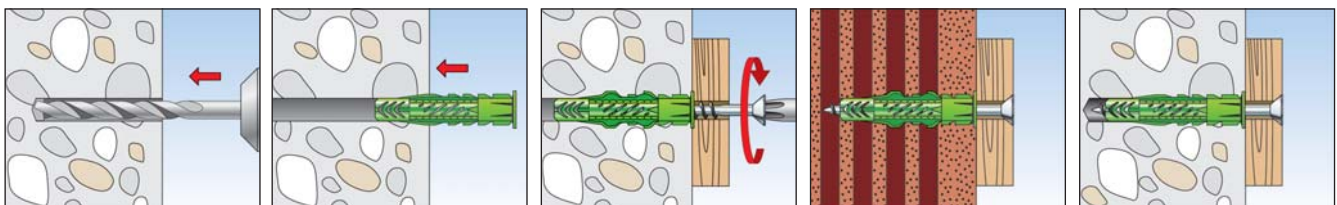

TECHNICAL DATA

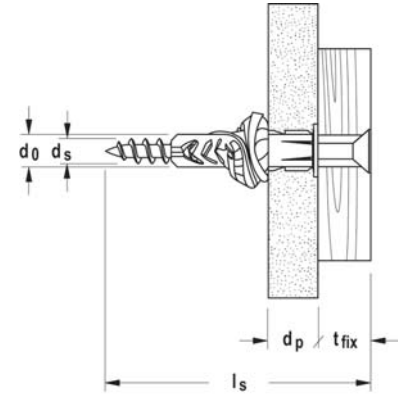
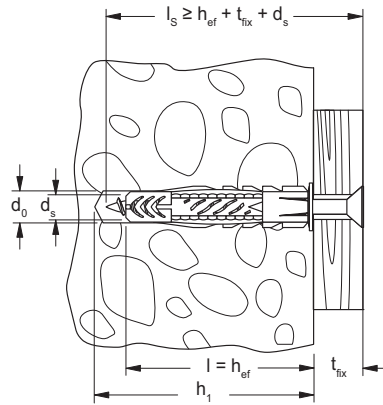

Universal plug **UX GREEN R** - with rim

Item	With rim	Without rim	Drill hole diameter d_0 [mm]	Min. drill hole depth h_1 [mm]	Min. panel thickness d_p [mm]	Anchor length l [mm]	Wood and chip-board screws $d_s / d_s \times l_s$ [mm]	Sales unit [pcs]
	Art.-No.	Art.-No.						
	UX R	UX						
UX GREEN 6 x 35	518885	—	6	45	9,5	35	4 - 5	40
UX GREEN 6 x 50	524855	—	6	60	9,5	50	4 - 5	40
UX GREEN 8 x 50	518886	—	8	60	9,5	50	4,5 - 6	40
UX GREEN 10 x 60	518887	—	10	75	12,5	60	6 - 8	20
UX GREEN 12 x 70	—	524858	12	85	—	70	8 - 10	18

LOADS

Universal plug UX GREEN

Highest recommended loads¹⁾ for a single anchor.

The given loads are valid for wood screws with the specified diameter.

Type			UX GREEN 6 x 35	UX GREEN 6 x 50	UX GREEN 8 x 50	UX GREEN 10 x 60	UX GREEN 12 x 70
Screw diameter	\emptyset	[mm]	5	5	6	8	10
Recommended loads in the respective base material F_{rec}²⁾							
Concrete	\geq C20/25	[kN]	0,40	0,60	0,60	1,00	1,50
Solid brick	\geq Mz 12	[kN]	0,20	0,30	0,30	0,50	0,70
Perforated sand-lime brick	\geq KSL 12	[kN]	0,40	0,40	0,50	0,60	0,80
Vertically perforated brick	\geq Hlz 12	[kN]	0,20	0,20	0,20	0,20	0,30
Aerated concrete	\geq AAC 4	[kN]	0,20	0,20	0,30	0,40	0,60
Gypsum plasterboard	12,5 mm	[kN]	0,10	0,10	0,10	0,10	-
Gypsum plasterboard	25 mm	[kN]	0,15	0,15	0,15	0,15	-
Gypsum fibreboard	(Fermacell)	[kN]	0,20	0,20	0,20	0,25	-
Gypsum block	$\rho \geq 0,9$ kg/dm ³	[kN]	-	-	0,15	0,35	0,45

¹⁾ Required safety factors are considered.

²⁾ Valid for tensile load, shear load and oblique load under any angle.

The powerful nylon plug with 4-way expansion

2
greenline

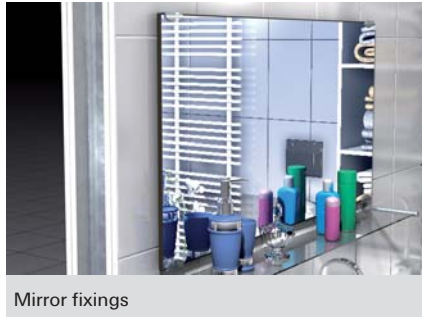

Mirror fixings



Wall consoles

BUILDING MATERIALS

- Concrete
- Vertically perforated brick
- Hollow blocks made from lightweight concrete
- Cavity floor slabs made from bricks and concrete
- Perforated sand-lime brick
- Solid sand-lime brick
- Natural stone with dense structure
- Aerated concrete
- Solid panel made from gypsum
- Solid brick made from lightweight concrete
- Solid brick

CERTIFICATES



ADVANTAGES

- Produced with at least 50% renewable raw materials and therefore particularly environmentally friendly.
- Just as effective, secure and durable as regular SX plugs.
- The powerful 4-way expansion provides optimum force transmission in the building material, thus enabling high load values and security.
- The anti-rotation lock prevents the plug from spinning in the drill hole.
- The expansion-free plug neck prevents the creation of expansion forces on the material whilst screwing in the screw. This helps to prevent damage to tiles and plaster.
- Fast and easy push-through installation reduces installation time.

APPLICATIONS

- Lighting
- Wardrobes
- Motion detectors
- Skirting
- Light shelves
- Mirror cabinets
- Letter boxes
- TV consoles
- Trellis
- Folding shutters
- Bath and toilet installations

FUNCTIONING

- The SX GREEN is suitable for pre-positioned and push-through installation.
- When screwing in the screw, the SX GREEN expands in four directions, thus providing a secure anchoring in the building material.
- The required screw length is given by the plug length + fixture thickness + 1 x screw diameter.
- Suitable for wood, chipboard and spacing screws.

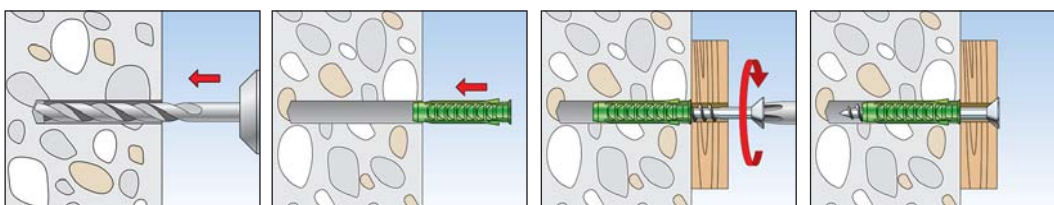

TECHNICAL DATA



Plug **SX GREEN** - with rim



Plug **SX GREEN** - with greater anchorage depth, without rim



Plug **SX GREEN S** - with rim and screw

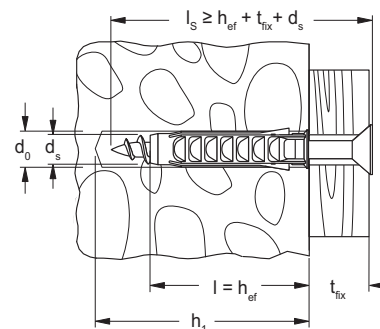

	With rim	Without rim and large anchorage depth	With rim and screw	Drill hole diameter	Min. drill hole depth	Anchor length	Max. fixture thickness	Wood and chip-board screws	Sales unit
	Art.-No.	Art.-No.	Art.-No.	d_0 [mm]	h_1 [mm]	l [mm]	t_{fix} [mm]	$d_s / d_s \times l_s$ [mm]	[pcs]
Item	SX	SX	SX-S						
SX GREEN 5 x 25	524859	—	—	5	35	25	—	3 - 4	90
SX GREEN 6 x 30	524860	—	—	6	40	30	—	4 - 5	90
SX GREEN 6 x 30	—	—	524866	6	40	30	5	4,5 x 40	45
SX GREEN 6 x 50	—	524861	—	6	60	50	—	4 - 5	90
SX GREEN 8 x 40	524862	—	—	8	50	40	—	4,5 - 6	90
SX GREEN 8 x 40	—	—	524867	8	60	40	15	5 x 60	45
SX GREEN 8 x 65	—	524863	—	8	75	65	—	4,5 - 6	45
SX GREEN 10 x 50	524864	—	—	10	70	50	—	6 - 8	45
SX GREEN 12 x 60	524865	—	—	12	80	60	—	8 - 10	20

LOADS

Expansion plug SX GREEN

Highest recommended loads¹⁾ for a single anchor.
The given loads are valid for wood screws with the specified diameter.

Type		SX GREEN 5 x 25	SX GREEN 6 x 30 SX GREEN 6 x 50	SX GREEN 8 x 40 SX GREEN 8 x 65	SX GREEN 10 x 50	SX GREEN 12 x 60
Wood screw diameter	\emptyset [mm]	4	5	6	8	10
Min. edge distance concrete	c_{min} [mm]	25	35	40	50	65
Recommended loads in the respective base material F_{rec}²⁾						
Concrete	$\geq C20/25$ [kN]	0,30	0,65	0,70	1,20	1,70
Solid brick	$\geq Mz 12$ [kN]	0,25	0,30	0,60	0,65	0,70
Solid sand-lime brick	$\geq KS 12$ [kN]	0,30	0,50	0,60	1,20	1,70
Aerated concrete	$\geq AAC 2$ [kN]	0,03	0,03	0,04	0,09	0,14
Aerated concrete	$\geq AAC 4$ [kN]	0,09	0,09	0,14	0,30	0,45
Vertically perforated brick	$\geq Hlz 12$ ($\rho \geq 1.0 \text{ kg/dm}^3$) [kN]	0,07	0,07	0,17	0,17	0,26
Perforated sand-lime brick	$\geq KSL 12$ [kN]	0,17	0,30	0,35	0,30	0,35
Gypsum block	[kN]	-	-	0,26	0,37	1,00

¹⁾ Required safety factors are considered.

²⁾ Valid for tensile load, shear load and oblique load under any angle.

The fastest installation in gypsum plasterboard

2
greenline



BUILDING MATERIALS

- Gypsum plasterboard, single and double-planked

CERTIFICATES



ADVANTAGES

- Produced with at least 50% renewable raw materials and therefore particularly environmentally friendly.
- Just as effective, secure and durable as regular GK plugs.
- The included setting tool combine the functions of drilling and setting fixings for direct and easy installation.
- Sharp, self-tapping thread for a positive-fit connection with a high load-bearing capacity.
- The cross-drive recess in the head of the fixing means that the GK GREEN can also easily be screwed out like a screw.
- The GK GREEN can be used with various screws, hooks and eye screws, making it very versatile in its applications.

APPLICATIONS

- Pictures
- Lighting
- Electrical installations
- Fitting accessories
- Series installations

FUNCTIONING

- The gypsum plasterboard fixing GK GREEN is suitable for pre-positioned installation.
- The GK GREEN is screwed flush into the gypsum plasterboard using the setting tool provided. Avoid manual and machine-aided overtightening.
- For board thicknesses greater than 15 mm, drill a hole first by using the setting tool.
- Adapted for wood, sheet metal and chipboard screws with a diameter of 4.0 to 5.0 mm.
- Not suitable for gypsum fibreboard and tiled plasterboard.

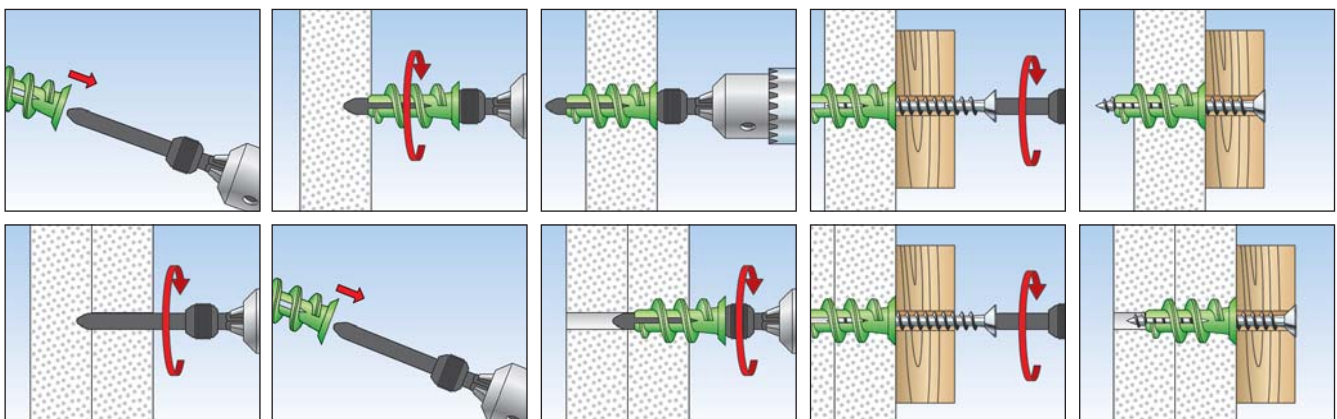

TECHNICAL DATA

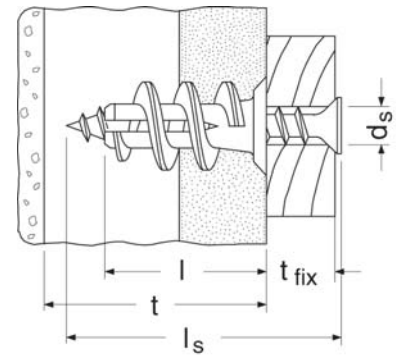

Item	Art.-No.	Anchor length l [mm]	Min. thickness to first supporting layer t [mm]	Max. fixture thickness t _{fix} [mm]	Screw d _s x l _s [mm]	Drive	Sales unit [pcs]
GK GREEN	524868 1) 2)	22	25	—	4,0 - 5,0 x Ls	—	90
GK GREEN S	524869 1) 3)	22	25	13	4,5 x 35	PZ2	45

1) Including installation tool GWK.

2) Min. screw length = length of plug 22 mm + thickness of building component.

3) Supplied with plasterboard screw.

LOADS

Plasterboard fixing GK GREEN

Highest recommended loads¹⁾ for a single anchor.

The given loads are valid for chipboard screws with the specified diameters.

Type	GK GREEN	
Chipboard screw	Ø [mm]	4,0 - 5,0
Recommended loads in the respective base material F_{rec} ²⁾		
Gypsum plasterboard	9,5 mm [kN]	0,07
Gypsum plasterboard	12,5 mm [kN]	0,08
Gypsum plasterboard	2 x 12,5 mm [kN]	0,11

¹⁾ Required safety factors are considered.

²⁾ Valid for tensile load, shear load and oblique load under any angle.

The hammer-in plug for simple, fast and economic installation

2
greenline



Timber substructures

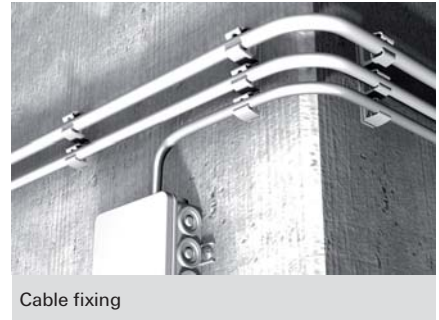

Cable fixing

BUILDING MATERIALS

- Concrete
- Solid sand-lime brick
- Building brick
- Natural stone
- Solid brick made from lightweight concrete
- Aerated concrete
- Solid panel made from gypsum
- Vertically perforated brick
- Perforated sand-lime brick
- Hollow blocks made from lightweight concrete

CERTIFICATES



ADVANTAGES

- Produced with at least 50% renewable raw materials and therefore particularly environmentally friendly.
- Just as effective, secure and durable as regular hammerfix N plugs.
- The rapid push-through and hammer-set installation reduces the amount of work required and allows for economic series installation.
- The integrated hammer-in stop prevents the plug from expanding prematurely, thus enabling problem-free installation.
- Together with the cross-slot recess, the thread of the nail screw allows the screw to be removed, thus allowing for subsequent dismantling.

APPLICATIONS

- Substructures made of wood and metal
- Wall connection or plaster profiles
- Slides
- Sheets
- Cable and pipe clips
- Perforated tapes

FUNCTIONING

- The hammerfix N GREEN is suitable for push-through installation.
- The easiest installation: drill, knock in and you're done.
- When being hammered in, the nail screw causes the plug to expand in two directions, thus providing a secure anchoring in the building material.

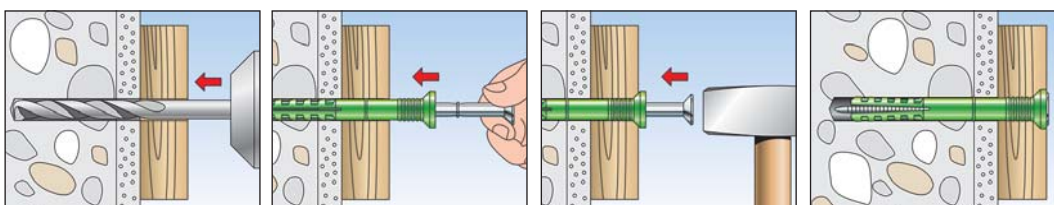

TECHNICAL DATA



Hammerfix **N GREEN S** with countersunk head and zinc-plated nail

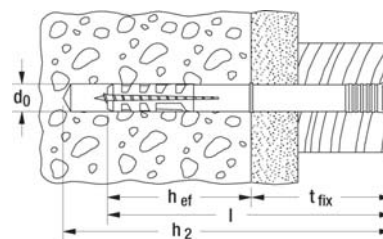

Item	Art.-No.	Drill hole diameter d_0 [mm]	Effect. anchorage depth h_{ef} [mm]	Anchor length l [mm]	Min. drill hole depth for through fixings h_2 [mm]	Max. fixture thickness t_{fix} [mm]	Drive	Sales unit [pcs]
N GREEN 6 x 40/10 S	524845	6	30	40	55	10	PZ2	45
N GREEN 6 x 60/30 S	524847	6	30	60	75	30	PZ2	45
N GREEN 6 x 80/50 S	524848	6	30	80	95	50	PZ2	45
N GREEN 8 x 80/40 S	524849	8	40	80	95	40	PZ3	45
N GREEN 8 x 100/60 S	524850	8	40	100	115	60	PZ3	45

LOADS

Hammerfix N GREEN S

Highest recommended loads¹⁾ for a single anchor.

The given loads are valid for screw nails with the specified diameter.

Type		N GREEN 6	N GREEN 8
Screw nail diameter	\emptyset [mm]	4	5
Recommended loads in the respective base material F_{rec}²⁾			
Concrete	\geq C20/25 [kN]	0,25	0,27
Solid brick	\geq Mz 12 [kN]	0,18	0,24
Solid sand-lime brick	\geq KS 12 [kN]	0,22	0,24
Solid brick of lightweight aggregate concrete	\geq V 4 [kN]	0,12	0,15
Aerated concrete	\geq AAC 2 [kN]	0,04	0,05
Aerated concrete	\geq AAC 4 [kN]	0,10	0,13

¹⁾ Required safety factors are considered.

²⁾ Valid for tensile load, shear load and oblique load under any angle.

Secure in aerated concrete

2
greenline



Radiators



Suspended ceilings

BUILDING MATERIALS

Suitable for:

- Aerated concrete \geq AAC 2
- Aerated concrete and ceiling panels of compressive strength \geq 3.3

CERTIFICATES



ADVANTAGES

- Produced with at least 50% renewable raw materials and therefore particularly environmentally friendly.
- The spiral-shaped outer ribs cut a positive fit in the soft building material, thus ensuring best pressure distribution and load-bearing capacity.
- Can be applied with a hammer – there is no need for special tools, thus saving time and money for the installation.

APPLICATIONS

- Suspended ceilings
- Cable trays
- Pipelines
- Guard rails
- Façade and roof constructions made of wood and metal
- Anopy brackets
- Letter boxes
- Trellis

FUNCTIONING

- The aircrete anchor GB GREEN is suitable for pre-positioned installation.
- The spiral-shaped outer ribs cut a positive fit into the soft building material when knocked in, thus ensuring optimal pressure distribution and load-bearing capacity.
- The required screw length is given by the plug length + fixture thickness + 1 x screw diameter.
- Rotary drilling of the hole is required.
- Can be used in unplastered aerated concrete.

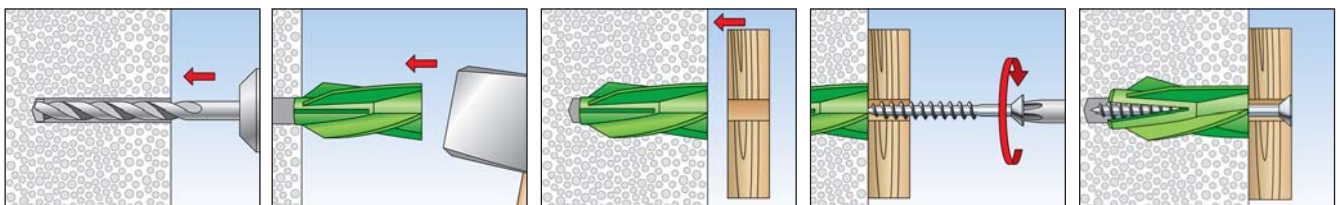

TECHNICAL DATA



Aircrete anchor **GB GREEN**

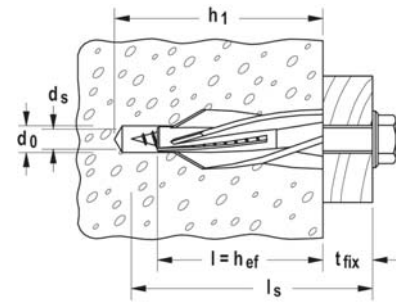

Item	Art.-No.	Drill hole diameter d_0 [mm]	Min. drill hole depth h_1 [mm]	Plug length = min. anchorage depth $l = h_{ef}$ [mm]	fischer safety screw $d_s \times l_s$ [mm]	Sales unit [pcs]
GB GREEN 8	524870	8	60	50	5	20
GB GREEN 10	524871	10	65	55	7	18

LOADS

Aircrete anchor GB GREEN

Highest recommended loads¹⁾ for a single anchor in aerated concrete.
The given loads are valid for fischer safety screws⁴⁾ acc. attached table.

Type			GB GREEN 8	GB GREEN 10
Diameter fischer safety screw	\emptyset	[mm]	5	7
Min. spacing ⁶⁾	s_{min}	[mm]	150 (100) ⁷⁾	100
Min. edge distance ²⁾	c_{min}	[mm]	100 (75) ⁷⁾	100
Minimum member thickness	h_{min}	[mm]	75	120
Anchorage depth	$h_{ef} (h_v)$	[mm]	50	55
Recommended load in the respective base material F_{rec}³⁾				
Aerated concrete	AAC 2	[kN]	0,20	0,21
Aerated concrete	AAC 3	[kN]	0,30	0,32 (0,43) ⁵⁾
Aerated concrete	AAC 4	[kN]	0,40	0,54 (0,71) ⁵⁾

¹⁾ Required safety factors are considered.

²⁾ Minimum possible edge distance.

³⁾ Valid for tensile load, shear load and oblique load under any angle.

⁴⁾ Galvanised steel (gvz) and stainless steel A4.

⁵⁾ The values in brackets are decisive for member thickness ≥ 150 mm.

⁶⁾ Minimum possible axial spacing while reducing the recommended load.

⁷⁾ Values in brackets apply to AAC 2.

Thermal bridge-free installation in insulation materials

2
greenline



Fixings in ETICS



Fixings in ETICS

BUILDING MATERIALS

- Non-plastered, pressure-resistant insulating boards
- Plastered, pressure-resistant insulating boards
- ETICS insulating boards

CERTIFICATES



ADVANTAGES

- Produced with at least 50% renewable raw materials and therefore particularly environmentally friendly.
- Just as effective, secure and durable as regular FID plugs. To fix lightweight fixtures in plastered and non-plastered insulating boards.
- Thermal bridge-free mounting when exclusively set in insulation material.
- Installation without pre-drilling even through thin plaster layers, thus saving a work step.
- Easy to set using a standard bit.

APPLICATIONS

To fix lightweight fixtures in plastered and non-plastered insulating boards.

The areas of application are:

- Façade construction (ETICS)
- Insulating construction
- Electric construction
- Refrigerated and climate construction
- Acoustic construction

FUNCTIONING

- The FID GREEN can be set in pre-positioned installation with a cordless screwdriver or by hand.
- With its strong drill tip, the insulation fixing FID GREEN breaks through thin plaster layers and cuts a positive fit into the insulation panel with its specially shaped spiral thread.
- From a plaster thickness of 5 mm, we recommend to create a 6 mm hole. This serves for better guidance of the fastener in the setting process.
- Water ingress in the insulation material can be prevented by sealing the plug collar after successful installation.
- Attachment parts can be easily attached with screws.
- We recommend to predrill an 6 mm hole in ETICS rendering.

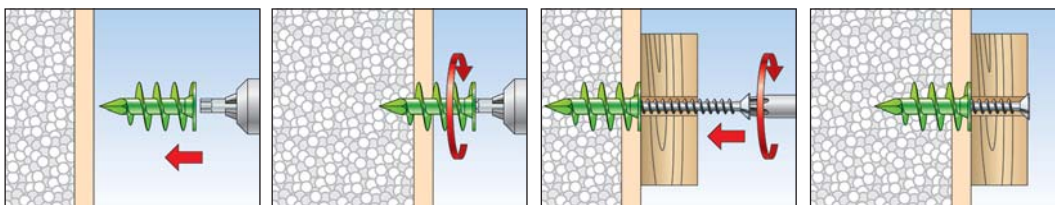

TECHNICAL DATA



Insulation fixing **FID GREEN 50**



Insulation fixing **FID GREEN 90**

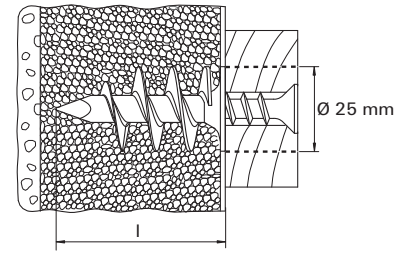

Item	Art.-No.	Anchor length l [mm]	Min. bolt penetration [mm]	Wood and chipboard screws d _s [mm]	Drive	Sales unit [pcs]
FID GREEN 50	524851	50	50	4,5 - 5	T40	45
FID GREEN 90	524852	90	90	6	Inbus 6 mm	20

LOADS

Insulation fixing FID GREEN

Highest recommended loads¹⁾ for a single anchor.

The given loads are valid for chipboard screws with maximum diameter.

Type			FID GREEN 50	FID GREEN 90
Screw diameter	Ø	[mm]	4,5 - 5,0	6,0
Recommended loads in the respective base material N_{rec}²⁾				
Polystyrene	PS 15	[kN]	0,07	0,17
Polystyrene	PS 20	[kN]	0,10	0,20

¹⁾ Required safety factors are considered.

²⁾ Valid for tensile load.

The first approved injection mortar made with renewable raw materials

2
greenline

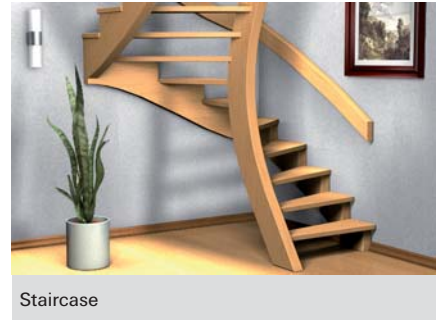

BUILDING MATERIALS

Approved for anchorings in:

- Concrete C20/25 to C50/60, non-cracked
- Solid brick
- Vertically perforated brick
- Solid sand-lime brick
- Perforated sand-lime brick
- Aerated concrete

CERTIFICATES

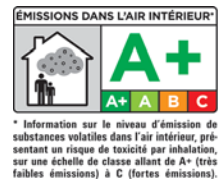
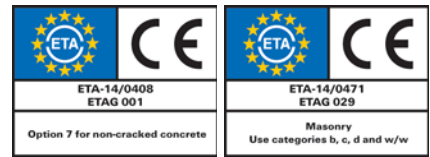

ADVANTAGES

- The worldwide first injection mortar with renewable raw materials. The share of renewable raw materials is certified by DIN CERTCO / TÜV Rheinland.
- Because of the European Technical Assessment it is possible to use the injection system in the area of public buildings.
- The low content of volatile organic compounds (VOC) has a positive effect for the evaluation of fixings in „Green Building“-projects.
- Biobased raw materials increase the residential and workplace quality and preserve valuable resources for future generations.
- The injection system is not mandatory for indication and thus reduces risks for installers and the environment.
- FIS GREEN is suitable for the use with the complete fischer injection accessories.

APPLICATIONS

Injection mortar for use with:

- Threaded rods FIS A, see page 144
- Internal threaded anchor RG MI, see page 159
- Rebar anchor FRA, see page 179
- Concrete steel bars, see page 185
- Injection anchor sleeves FIS H, see page 167
- NSF certificate verifies its suitability for applications in drinking water

FUNCTIONING

- FIS GREEN is a 2-component injection mortar.
- Resin and hardener are stored in two separate chambers and are not mixed and activated until extrusion through the static mixer.
- The injection cartridges are quick and easy to use with the fischer dispensers.
- Partially used cartridges can be reused by changing the static mixer.
- Related accessories for the various applications can be found on pages „non-cracked concrete“ and „masonry“.

SEE ALSO



ANCHORS + SLEEVES

Page 144



DISPENSER

Page 195

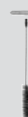

ACCESSORIES

Page 198

INSTALLATION WITH FIS EB, FIS GREEN

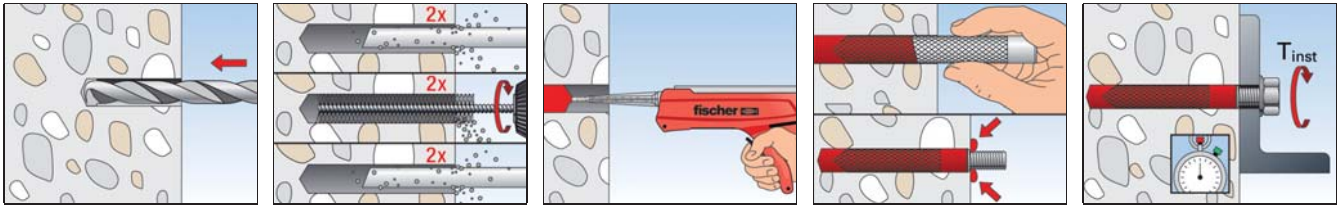

INSTALLATION

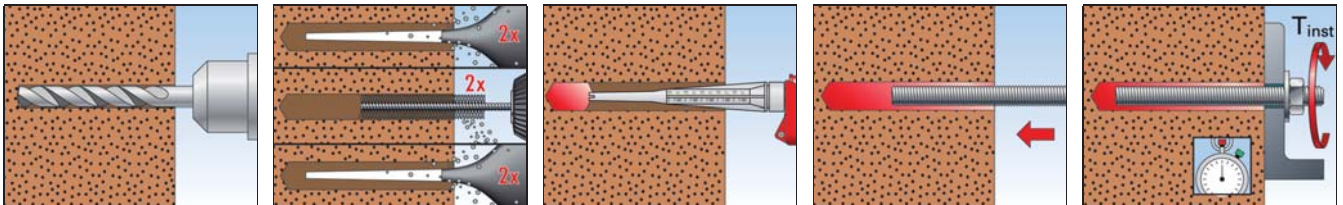

INSTALLATION

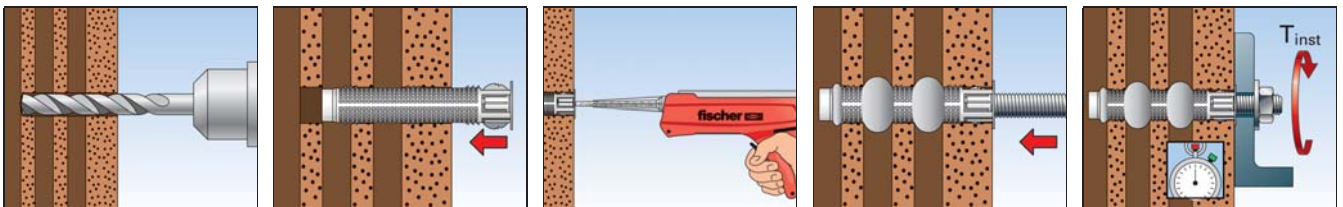

INSTALLATION - UNDERCUT DRILL HOLE

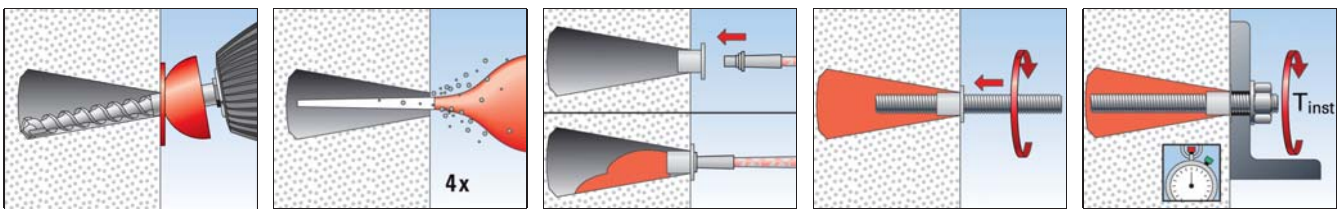

INSTALLATION - CYLINDRICAL DRILL HOLE

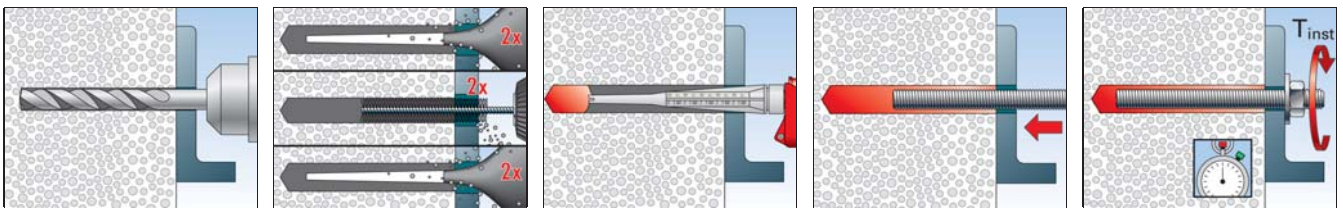

TECHNICAL DATA



FIS GREEN 300 T



Static mixer FIS MR Plus

greenline 2

Item	Art.-No.	Approval ETA	Languages on the cartridge	Scale unit	Contents	Sales unit [pcs]
FIS GREEN 300 T	522223	■	DE	150	1 cartridge 300 ml, 2 x FIS MR Plus	12
FIS GREEN 300 T K	523244	■	DE	150	1 Cartridge 300 ml, 2 x Static mixer (incl. clip with europerforation)	4
FIS GREEN 300 T	522989	■	FR	150	1 cartridge 300 ml, 2 x FIS MR Plus with transparent Clip	4
FIS GREEN 300 T	523245	■	IT	150	1 cartridge 300 ml, 2 x FIS MR Plus with transparent Clip	12
FIS GREEN 300 T	538219	■	CS, SK	150	1 cartridge 300 ml, 2 x FIS MR Plus	12
FIS GREEN 300 T	532972	■	DA, SV, NO, FI	150	1 cartridge 300 ml, 2 x FIS MR Plus with transparent Clip	12
FIS MR Plus	545853	—	—	—	10 static mixer FIS MR Plus	10

LOADS

Injection system FIS GREEN: Injection mortar FIS GREEN with Threaded rod FIS A ¹⁾

zinc plated steel / stainless steel / high corrosion resistant steel

Permissible loads of a single anchor in non-cracked normal concrete (concrete compression zone) of strength class C20/25 (~B25) ²⁾³⁾⁴⁾⁵⁾										Minimum spacings while reducing the load		
Type	Material fixing element	Min. member thickness	Effective anchorage depth	Maximum torque moment	Permissible tensile load	Permissible shear load	Required edge distance (with one edge) for		Required spacing for	Min. spacing	Min. edge distance	
							Max. tension load c	Max. shear load c				Max. Load s _{cr}
		h _{min} [mm]	h _{ef} ⁶⁾ [mm]	T _{max} [Nm]	N _{perm} ⁷⁾ [kN]	V _{perm} ⁷⁾ [kN]	[mm]	[mm]	[mm]	[mm]	[mm]	
M8	5.8	100	60	10	5,7	5,1	90	70	180	40	40	
		110	80		7,6				240			
		190	160		9,0		40	60	480			
	8.8	100	60		5,7	8,6	90	130	180			240
		110	80		7,6							115
		190	160		14,3		85	90	480			
	A4-70	100	60		5,7	6,0	90	85	180			240
		110	80		7,6							75
		190	160		9,9		50	70	480			
	C-70	100	60		5,7	7,4	90	110	180			240
		110	80		7,6							100
		190	160		12,4		70	80	480			
M10	5.8	100	60	20	6,7	8,6	90	125	180	45	45	
		120	90		10,1				110			105
		230	200		13,8		55	85	600			
	8.8	100	60		6,7	13,1	90	200	180			270
		120	90		10,1							170
		230	200		22,4		110	115	600			
	A4-70	100	60		6,7	9,2	90	135	180			270
		120	90		10,1							110
		230	200		15,7		65	90	600			
	C-70	100	60		6,7	11,4	90	170	180			270
		120	90		10,1							110
		230	200		19,5		95	105	600			

LOADS

Injection system FIS GREEN: Injection mortar FIS GREEN with Threaded rod FIS A ¹⁾

zinc plated steel / stainless steel / high corrosion resistant steel

Permissible loads of a single anchor in non-cracked normal concrete (concrete compression zone) of strength class C20/25 (~B25) ²⁾³⁾⁴⁾⁵⁾										Minimum spacings while reducing the load					
Type	Material fixing element	Min. member thickness	Effective anchorage depth	Maximum torque moment	Permissible tensile load	Permissible shear load	Required edge distance (with one edge) for		Required spacing for	Min. spacing	Min. edge distance				
		h_{min} [mm]	$h_{ef}^{6)}$ [mm]	T_{max} [Nm]	$N_{perm}^{7)}$ [kN]	$V_{perm}^{7)}$ [kN]	Max. tension load c [mm]	Max. shear load c [mm]	Max. Load s_{cr} [mm]			$s_{min}^{8)9)}$ [mm]	$c_{min}^{8)9)}$ [mm]		
M12	5.8	100	70	40	8,9	12,0	105	175	210	55	55				
		140	110		14,0		130	130	330						
		270	240		20,5		70	100	720						
	8.8	100	70		8,9	19,4	105	295	210						
		140	110		14,0		130	230	330						
		270	240		30,5		150	720							
	A4-70	100	70		8,9	13,7	105	200	210						
		140	110		14,0		130	155	330						
		270	240		22,5		85	115	720						
	C-70	100	70		8,9	17,1	105	260	210						
		140	110		14,0		130	200	330						
		270	240		28,1		115	135	720						
M16	5.8	120	80	60	12,0	22,3	125	305	240	65	65				
		170	125		18,7		160	235	375						
		360	320		37,6		115	150	960						
	8.8	120	80		12,0	28,7	125	405	240						
		170	125		18,7		160	375							
		360	320		47,9		220	960							
	A4-70	120	80		12,0	25,2	125	350	240						
		170	125		18,7		160	270	375						
		360	320		42,0		135	165	960						
	C-70	120	80		12,0	28,7	125	405	240						
		170	125		18,7		160	350	375						
		360	320		47,9		195	960							
	M20	5.8	140		90	120	14,6	34,9	135			435	270	85	85
			220		170		27,6		190			300	510		
			450		400		58,6		165			195	1200		
8.8		140	90	14,6	35,0		135	440	270						
		220	170	27,6			190	525	510						
		450	400	64,8			290	1200							
A4-70		140	90	14,6	35,0		135	440	270						
		220	170	27,6			190	350	510						
		450	400	64,8			215	1200							
C-70		140	90	14,6	35,0		135	440	270						
		220	170	27,6			190	455	510						
		450	400	64,8			260	1200							

For the design the complete assessment ETA-14/0408 has to be considered. ¹⁰⁾

¹⁾ Also valid for anchor rod RG M in the same property class.

²⁾ The partial safety factors for material resistance as regulated in the ETA-14/0408 as well as a partial safety factor for load actions of $\gamma_L = 1,4$ are considered. As an single anchor counts e.g. an anchor with a spacing $s \geq 3 \cdot h_{ef}$ and an edge distance $c \geq 1,5 \cdot h_{ef}$. Accurate data see ETA-14/0408.

³⁾ The given loads are valid for injection mortar FIS GREEN for fixations in dry and humid concrete for temperatures in the substrate up to 50 °C (resp. short term up to 80 °C. For drill hole cleaning see ETA-14/0408.

⁴⁾ For higher concrete strength classes up to C50/60 higher permissible loads may be possible.

⁵⁾ Drill method hammer drilling.

⁶⁾ For the sizes M8 - M20 the min. anchorage depth and the max. anchorage depth are given. The anchorage depth can be chosen freely between these borders.

⁷⁾ For combinations of tensile loads, shear loads, bending moments as well as reduced edge distances or spacings (anchor groups) see ETA-14/0408.

⁸⁾ Minimum possible axial spacings resp. edge distance while reducing the permissible load.

⁹⁾ Minimum possible spacing resp. edge distance while reducing the permissible load for the required minimum member thickness. The combination of minimum edge distance and minimum spacing is not possible. One of both values has to be increased acc. ETA-14/0408.

¹⁰⁾ The given loads refer to the European Technical Assessment ETA-14/0408, issue date 19/12/2014. Design of the loads according ETAG 001, Technical Report TR 029 (for static resp. quasi-static loads).

LOADS

Injection system FIS GREEN: Injection resin FIS GREEN with Internal threaded anchor RGMI
zinc plated steel / stainless steel A4

2
greenline

Permissible loads of a single anchor in non-cracked normal concrete (concrete compression zone) of strength class C20/25 (~ B25) ¹⁾²⁾³⁾										Minimum spacings while reducing the load	
Type	Screw steel property/surface	Min. member thickness	Effective anchorage depth	Maximum torque moment	Permissible tensile load	Permissible shear load	Required edge distance (with one edge) for		Required spacing for	Min. spacing	Min. edge distance
							Max. tension load c	Max. shear load c			
		h_{min} [mm]	h_{ef} [mm]	T_{max} [Nm]	$N_{perm}^{4)}$ [kN]	$V_{perm}^{4)}$ [kN]	[mm]	[mm]	Max. Load s_{cr} [mm]	$s_{min}^{5)}$ [mm]	$c_{min}^{5)}$ [mm]
RG M8 I	5.8	120	90	10	9,0	5,3	95	65	270	55	55
	8.8										
	A4-70										
RG M10 I	5.8	130	90	20	13,8	8,3	145	90	270	65	65
	8.8										
	A4-70										
RG M12 I	5.8	170	125	40	20,2	12,1	190	110	375	75	75
	8.8										
	A4-70										
RG M16 I	5.8	210	160	80	27,8	22,4	240	180	480	95	95
	8.8										
	A4-70										

For the design the complete assessment ETA-14/0408 has to be considered. ⁶⁾

- ¹⁾ The partial safety factors for material resistance as regulated in the ETA-14/0408 as well as a partial safety factor for load actions of $\gamma_L = 1.4$ are considered. As an single anchor counts e.g. an anchor with a spacing $s \geq 3 \cdot h_{ef}$ and an edge distance $c \geq 1.5 \cdot h_{ef}$. Accurate data see ETA-14/0408.
- ²⁾ For higher concrete strength classes up to C50/60 higher permissible loads may be possible.
- ³⁾ Drill method hammer drilling. For further allowable application conditions see ETA-14/0408.
- ⁴⁾ For combinations of tensile loads and shear loads or for shear loads with lever arm (bending moments) as well as reduced edge distances or spacings (anchor groups) we recommend to use our anchor design software C-FIX.
- ⁵⁾ Minimum possible axial spacings resp. edge distance while reducing the permissible load.
- ⁶⁾ The given loads refer to the European Technical Assessment ETA-14/0408, issue date 19/12/2014. Design of the loads according ETAG 001, Technical Report TR 029 (for static resp. quasi-static loads).

LOADS

Injection system FIS GREEN with threaded rod FIS A⁴⁾

Highest permissible loads ¹⁾⁵⁾ for a single anchor in solid brick masonry (without injection anchor sleeve) for pre-positioned or push-through installation.

For the design the complete assessment ETA-14/0471 has to be considered.

Type	Compressive brick strength	Brick raw density	Minimum brick dimensions ⁶⁾	Min. effective anchorage depth	Min. member thickness	Maximum torque	Permissible tensile load ³⁾	Permissible shear load ³⁾	Characteristic spacing parallel to bed joint	Characteristic spacing perpendicular to bed joint	Min. spacing ²⁾	Characteristic resp. min. edge distance ²⁾
	f_b	ρ	(L x W x H)	h_{ef}	h_{min}	$T_{inst,max}$	N_{perm}	V_{perm}	$s_{cr \parallel}$	$s_{cr \perp}$	$s_{min \parallel} / s_{min \perp}$	$c_{cr} = c_{min}$
	[N/mm ²]	[kg/dm ³]	[mm]	[mm]	[mm]	[Nm]	[kN]	[kN]	[mm]	[mm]	[mm]	[mm]
Solid brick Mz, NF acc. to EN 771-1												
M8	≥10	≥1,8	240x115x71 (NF)	50	80	10	0,71	0,71	150	150	150	100
M10				50	80		0,86	1,14	150	150	150	100
M10				80	110		1,29	1,14	240	240	240	100
M10				200	230		3,14	2,43	300	300	300	150
M12				50	80		0,86	1,14	150	150	150	100
M12				80	110		1,43	1,14	240	240	240	100
M12	200	230	2,00	3,29	300	300	300	150				
M8	≥20	≥1,8	240x115x71 (NF)	50	80	10	0,71	1,14	150	150	150	100
M10				50	80		1,29	1,71	150	150	150	100
M10				80	110		1,71	1,71	240	240	240	100
M10				200	230		3,43	3,43	300	300	300	150
M12				50	80		1,14	1,57	150	150	150	100
M12				80	110		2,00	1,57	240	240	240	100
M12	200	230	2,86	3,43	300	300	300	150				

LOADS

Injection system FIS GREEN with threaded rod FIS A⁴⁾

Highest permissible loads^{1) 5)} for a single anchor in solid brick masonry (without injection anchor sleeve) for pre-positioned or push-through installation.

For the design the complete assessment ETA-14/0471 has to be considered.

Type	Compressive brick-strength f_b [N/mm ²]	Brick raw density ρ [kg/dm ³]	Minimum brick dimensions ⁶⁾ (L x W x H) [mm]	Min. effective anchorage depth h_{ef} [mm]	Min. member thickness h_{min} [mm]	Maximum torque $T_{inst,max}$ [Nm]	Permissible tensile load ³⁾ N_{perm} [kN]	Permissible shear load ³⁾ V_{perm} [kN]	Characteristic spacing parallel to bed joint $s_{cr \parallel}$ [mm]	Characteristic spacing perpendicular to bed joint $s_{cr \perp}$ [mm]	Min. spacing ²⁾ $s_{min \parallel} / s_{min \perp}$ [mm]	Characteristic resp. min. edge distance ²⁾ $c_{cr} = c_{min}$ [mm]			
Solid sand-lime brick KS acc. to EN 771															
M8	≥ 10	≥ 1,8	240x115x71 (NF)	50	80	10	0,71	1,14	150	150	150	100			
M10				50	80		0,71	1,14	150	150	150	100			
M10				80	110		0,86	1,14	240	240	240	100			
M10				200	230		2,57	1,14	300	300	300	150			
M12				50	80		0,57	1,43	150	150	150	100			
M12				80	110		0,86	1,43	240	240	240	100			
M12	200			230	2,57		1,43	300	300	300	150				
M8	≥ 20			≥ 1,8	240x115x71 (NF)		50	80	10	0,71	1,57	150	150	150	100
M10							50	80		0,86	1,57	150	150	150	100
M10							80	110		1,14	1,57	240	240	240	100
M10							200	230		3,43	1,57	300	300	300	150
M12							50	80		0,86	2,00	150	150	150	100
M12		80	110			1,29	2,00	240		240	240	100			
M12	200	230	3,43			2,00	300	300		300	150				

¹⁾ The required partial safety factors for material resistance as well as a partial safety factor for load actions of $\gamma_L = 1,4$ are considered.

²⁾ Minimum feasible spacings resp. edge distance. Details as well as to the distances to joints see assessment.

³⁾ For combinations of tensile loads, shear loads, bending moments as well as reduced edge distances or spacings (anchor groups) see assessment.

⁴⁾ Zinc-plated, stainless steel A4 and high corrosion-resistant steel C.

⁵⁾ The given loads are valid for installation and use of fixations in dry masonry - use category d/d - for temperatures in the substrate up to +50 °C (resp. short term up to 80 °C) and drill hole cleaning according to assessment. The given brick types in combination with the permissible loads are an extract of the assessment.

⁶⁾ Hole patterns see assessment.

LOADS

Injection system FIS GREEN with threaded rod FIS A⁵⁾ and anchor sleeve FIS H..K

Highest permissible loads^{1) 6)} for a single anchor in solid brick masonry (with injection anchor sleeve) for pre-positioned installation.

For the design the complete assessment ETA-14/0471 has to be considered.

Type of anchor sleeve with anchor rod	Compressive brick-strength f_b [N/mm ²]	Brick raw density ρ [kg/dm ³]	Minimum brick dimensions ⁶⁾ (L x W x H) [mm]	Min. effective anchorage depth ⁴⁾ h_{ef} [mm]	Min. member thickness h_{min} [mm]	Maximum torque $T_{inst,max}$ [Nm]	Permissible tensile load ³⁾ N_{perm} [kN]	Permissible shear load ³⁾ V_{perm} [kN]	Characteristic spacing parallel to bed joint $s_{cr \parallel}$ [mm]	Characteristic spacing perpendicular to bed joint $s_{cr \perp}$ [mm]	Min. spacing ²⁾ $s_{min \parallel} / s_{min \perp}$ [mm]	Characteristic resp. min. edge distance ²⁾ $c_{cr} = c_{min}$ [mm]		
Solid sand-lime brick KS acc. to EN 771														
12x85 M8	≥ 10	≥ 1,8	240x115x113	85	115	2	0,86	0,86	255	255	255	100		
16x85 M10						4	0,57	1,00						
20x85 M12						4	1,57	1,00						
12x85 M8	≥ 20			≥ 1,8	240x115x113	85	115	2					1,29	1,29
16x85 M10								4					0,86	1,57
20x85 M12								4					2,29	1,57

¹⁾ The required partial safety factors for material resistance as well as a partial safety factor for load actions of $\gamma_L = 1,4$ are considered.

²⁾ Minimum feasible spacings resp. edge distance. Details as well as to the distances to joints see assessment.

³⁾ For combinations of tensile loads, shear loads, bending moments as well as reduced edge distances or spacings (anchor groups) see assessment.

⁴⁾ The maximum anchorage depth is corresponding with the relevant anchor sleeves FIS H..K (see technical data).

⁵⁾ Zinc-plated, stainless steel A4 and high corrosion-resistant steel C.

⁶⁾ The given loads are valid for installation and use of fixations in dry masonry - use category d/d - for temperatures in the substrate up to +50 °C (resp. short term up to 80 °C) and drill hole cleaning according to assessment. The given brick types in combination with the permissible loads are an extract of the assessment.

⁷⁾ Hole patterns see assessment.

LOADS

Injection system FIS GREEN with threaded rod FIS A⁵⁾ and anchor sleeve FIS H..K

Highest permissible loads^{1) 6)} for a single anchor in perforated brick masonry (with injection anchor sleeve) for pre-positioned installation. For the design the complete assessment ETA-14/0471 has to be considered.

Type of anchor sleeve with anchor rod	Compressive brick-strength f_b [N/mm ²]	Brick raw density ρ [kg/dm ³]	Minimum brick-dimensions ⁷⁾ (L x W x H) [mm]	Min. effective-anchorage depth ⁴⁾ h_{ef} [mm]	Min. member thickness h_{min} [mm]	Maximum torque $T_{inst,max}$ [Nm]	Permissible tensile load ³⁾ N_{perm} [kN]	Permissible shear load ³⁾ V_{perm} [kN]	Characteristic spacing parallel to bed joint $s_{cr \parallel}$ [mm]	Characteristic spacing perpendicular to bed joint $s_{cr \perp}$ [mm]	Min. spacing ²⁾ $s_{min \parallel} / s_{min \perp}$ [mm]	Characteristic resp. min. edge distance ²⁾ $c_{cr} = c_{min}$ [mm]
Vertically perforated brick Hz, acc. to EN 771-1												
12x85 M6/M8	≥ 8	≥ 1,4	230x108x55	85	115	2,0	0,57	0,71	230	55	230 / 55	100
16x85 M8/M10												
20x85 M12/M16												
12x85 M6/M8	≥ 10	≥ 0,9	240x175x113	85	175	2,0	0,57	1,14	240	115	240 / 115	120
16x85 M8/M10							0,57	1,57				
20x85 M12/M16							0,71	1,71				
Perforated sand-lime brick KSL acc. to EN 771-2												
12x85 M6/M8	≥ 12	≥ 1,4	240x175x113	85	175	2,0	0,34	0,71	240	115	240 / 115	100
16x85 M8/M10							0,57	1,57				
20x85 M12/M16							0,57	1,29				
12x85 M6/M8	≥ 20	≥ 1,4	240x175x113	85	175	2,0	0,57	1,29	240	115	240 / 115	100
16x85 M8/M10							1,00	2,29				
20x85 M12/M16							1,00	2,14				

¹⁾ The required partial safety factors for material resistance as well as a partial safety factor for load actions of $\gamma_L = 1,4$ are considered.

²⁾ Minimum feasible spacings resp. edge distance. Details as well as to the distances to joints see assessment.

³⁾ For combinations of tensile loads, shear loads, bending moments as well as reduced edge distances or spacings (anchor groups) see assessment.

⁴⁾ The maximum anchorage depth is corresponding with the relevant anchor sleeves FIS H..K (see technical data).

⁵⁾ Zinc-plated, stainless steel A4 and high corrosion-resistant steel C.

⁶⁾ The given loads are valid for installation and use of fixations in dry masonry - use category d/d - for temperatures in the substrate up to +50 °C (resp. short term up to 80 °C) and drill hole cleaning according to assessment. The given brick types in combination with the permissible loads are an extract of the assessment.

⁷⁾ Hole patterns see assessment.

LOADS

Injection system FIS GREEN with threaded rod FIS A⁴⁾

Highest permissible loads^{1) 5)} for a single anchor in aerated concrete.

For the design the complete assessment ETA-14/0471 has to be considered.

Type anchor rod	Compressive brick-strength f_b [N/mm ²]	Brick raw density ρ [kg/dm ³]	Minimum brick dimensions (L x W x H) [mm]	Min. effective-anchorage depth h_{ef} [mm]	Min. member thickness h_{min} [mm]	Maximum torque $T_{inst,max}$ [Nm]	Permissible tensile load ³⁾ N_{perm} [kN]	Permissible shear load ³⁾ V_{perm} [kN]	Characteristic spacing parallel to bed joint $s_{cr \parallel}$ [mm]	Characteristic spacing perpendicular to bed joint $s_{cr \perp}$ [mm]	Min. spacing ²⁾ $s_{min \parallel} / s_{min \perp}$ [mm]	Characteristic resp. min. edge distance ²⁾ $c_{cr} = c_{min}$ [mm]	
Aerated concrete acc. to EN 771-4													
M8	≥ 2	≥ 0,35					1	0,71	0,32	240	115	240 / 115	80
M10							2	0,71	0,32				
M12							2	0,89	0,32				
M16							2	0,89	0,43				
M8	≥ 4	≥ 0,50		100	130		1	0,89	0,54	240	115	240 / 115	80
M10							2	1,07	0,54				
M12							2	1,07	0,54				
M16							2	1,07	0,54				
M8	≥ 6	≥ 0,65					1	1,25	0,89	240	115	240 / 115	80
M10							2	1,43	0,89				
M12							2	1,43	0,89				
M16							2	1,43	0,71				

¹⁾ The required partial safety factors for material resistance as well as a partial safety factor for load actions of $\gamma_L = 1,4$ are considered.

²⁾ Minimum feasible spacings resp. edge distance. Details as well as to the distances to joints see assessment.

³⁾ For combinations of tensile loads, shear loads, bending moments as well as reduced edge distances or spacings (anchor groups) see assessment.

⁴⁾ Zinc-plated, stainless steel A4 and high corrosion-resistant steel C.

⁵⁾ The given loads are valid for installation and use of fixations in dry masonry - use category d/d - for temperatures in the substrate up to +50 °C (resp. short term up to 80 °C) and drill hole cleaning according to assessment. The given brick types in combination with the permissible loads are an extract of the assessment.



fischer
FIS SB
390 S
SUPERBOND-MÖRTEL
SUPERBOND-MALTER
SUPERBOND-MALTA
ПАСТБОП СУПЕРБОНД

- ✓ Padonirka silikonsilikonov
za dno, stranice, površine
i sigurnost na betonu
- ✓ Padonirka silikonsilikonov
za betone površine
i sigurnost u betonu
- ✓ Padonirka silikonsilikonov
za betone površine
i sigurnost u betonu
- ✓ Padonirka silikonsilikonov
za betone površine
i sigurnost u betonu

Materiali / Materijali / Материјали
Cement / ЦЕМЕНТ



















System / Систем / Система / Система











fischer
FIS V
390 S
SUPERBOND-MÖRTEL
SUPERBOND-MALTER
SUPERBOND-MALTA
ПАСТБОП СУПЕРБОНД

1000 ml / 1000 ml / 1000 ml / 1000 ml















1000 ml / 1000 ml / 1000 ml / 1000 ml

3 Chemical fixings

	Page
MORTARS AND CAPSULES FOR GENERAL APPLICATIONS	
Introduction	48
Highbond-System FHB II 	52
Highbond-System FHB II Inject 	59
Superbond-System FSB 	64
Resin anchor RM II 	79
Epoxy mortar FIS EM Plus 	86
Epoxy mortar FIS EB 	95
Injection mortar FIS V 	101
Injection mortar FIS VL 	117
Injection mortar FIS GREEN 	126
Injection mortar FIS P Plus 	133
Injection mortar FIS P 	140
ANCHOR RODS	
Introduction	144
Threaded rod FIS A 	146
Threaded rod RG M 	154
Internal threaded anchor RG M I 	159
Internal threaded anchor FIS E 	161
Accessories for push-trough installation 	164
Anchor sleeve FIS H K 	167
Anchor sleeve FIS H L 	167
Anchor sleeve FIS H N 	167









	Page
SPECIAL APPLICATIONS	
Introduction	169
Highbond anchor dynamic FHB dyn 	170
Dynamic-Anchor FDA 	174
UMV multicone dynamic bonded anchor 	176
Rebar connections 	179
Concrete-Concrete Shear Connector FCC 	185
Remedial wall tie VBS 8 	187
Weather facing reconstruction system FWS II 	189
Can System FCS 	191
Fill & Fix injection fixing 	193
DISPENSERS 	196
ACCESSORIES 	198

Mortars and Applications



















Positioning	Approved Substrates (ETA)					Approved Features										Page
						Post-installed Rebar Connection	ICC	Fire Resistance R120	Seismic Approval	Waterfilled drill hole	Diamond drilling	Hollow drilling	Dynamic loads	Others		
 Highbond-System FHB II The best performance in cracked concrete	■	■						■						ZTV 1200 °C, BZS shock tested	52	
 Superbond-System FSB The concrete all-rounder	■	■				■	■	■	C1, C2					Under-water applications	64	
 Epoxy mortar FIS EM Plus The powerful injection mortar for rebar connections and cracked concrete	■	■				■	■	■	C1, C2	■	■	■			86	
 Epoxy mortar FIS EB The basic epoxy mortar for applications in concrete	■	■				■		■	C1, C2	■	■	■			95	
 Injection mortar FIS V The versatile injection mortar for anchorings in masonry and cracked concrete	■	■	■	■	■	■	■	■	C1, C2	■		■			101	
 Injection mortar FIS VL The solid injection mortar for standard applications in cracked concrete and masonry	■	■	■	■	■	■		■		■		■			117	
 Injection mortar FIS GREEN The first approved mortar made with renewable raw materials		■	■	■	■			■						Biobased, EPD, Émission Dans L'Air Intérieur, NSF	126	
 Injection mortar FIS P Plus The approved injection mortar for anchorings in masonry		■	■	■	■			■		■		■			133	
 Injection mortar FIS P The reliable injection mortar for anchorings in masonry			■	■	■										140	

■ = approved
 ■ = recommendation

Mortars and Applications













Positioning	Approved Substrates (ETA)					Approved Features								Page	
	 Cracked Concrete	 Non-cracked Concrete	 Solid Masonry	 Perforated Masonry	 Aerated Concrete	Post-installed Rebar Connection	ICC	Fire Resistance R120	Seismic Approval	Waterfilled drill hole	Diamond drilling	Hollow drilling	Dynamic loads		Others
 Resin capsules FHB II-P, FHB II-PF High Speed	The best performance in cracked concrete	■	■					■		■		■			53
 Resin capsules RSB	The concrete all-rounder	■	■					■	C1	■	■	■			73
 Resin capsules RM II	Bonded anchor for cracked concrete without drill hole cleaning	■	■					■		■		■			80
 UMV-P	The capsule system for the anchoring of dynamic loads	■	■										■		176

Mortars and Anchors

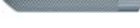
Mortar Cartridges	 FIS HB	 FIS SB	 FIS EM Plus	 FIS EB	 FIS V	 FIS VL	 FIS GREEN	 FIS P Plus	 FIS P	Page
Positioning	Best performance in concrete	Concrete all-rounder	Powerful rebar connections + cracked concrete	Basic Epoxy mortar for concrete	Versatile mortar for masonry und cracked concrete	Solid mortar for standard anchorings in masonry and cracked concrete	First approved mortar made with renewable raw materials	Approved for Masonry	Reliable in masonry	
 Threaded Rod FIS A		■	■	■	■	■	■	■	(■)	146
 Threaded Rod RG M		■	■	■	■	■	■	■	(■)	154
 Internal Threaded Anchor RG M I		■	■		■	■	■			159
 Internal Threaded Socket FIS E					■	■	■	■	(■)	161
 Highbond Anchor FHB II-A L / FHB II-AS	■									26
 Highbond Anchor FHB II-A L Inject / FHB II-A S Inject	■									59
 FHB dyn	■									170
 FDA	■									174
 UMV-A dyn										176

■ = approved - (■) = recommendation

Mortars and Anchors

Mortar Capsules	 FHB II-P, FHB II-PF High Speed	 RSB	 RM II	 UMV-P	Page
Positioning	Best performance in concrete	Concrete all-rounder	Bonded anchor for cracked concrete without drill hole cleaning	Capsule system for dynamic loads	
 Threaded Rod FIS A					140
 Threaded Rod RG M		■	■		154
 Internal Threaded Anchor RG M I		■	■		159
 Internal Threaded Socket FIS E					161
 Highbond Anchor FHB II-A L / FHB II-AS	■				26
 Highbond Anchor FHB II-A L Inject / FHB II-A S Inject					59
 FHB dyn					170
 FDA					174
 UMV-A dyn				■	176

The best performance in cracked concrete

3
Chemical fixings



Banisters



Steel girders

VERSIONS

- Zinc-plated steel
- Stainless steel
- Highly corrosion-resistant steel

BUILDING MATERIALS

Approved for:

- Concrete C20/25 to C50/60, cracked and non-cracked

Also suitable for:

- Concrete C12/15

CERTIFICATES



Shock-tested: BZS approval for shockproof fixings in civilian shelters.



ADVANTAGES

- The Highbond system FHB II achieves the highest load values in cracked concrete. Thus fewer fixing points and smaller anchor plates are required.
- The injection mortar FIS HB and the capsules FHB II-P/PF offer the same performance and can be used with the FHB II-A S (short version) or L (long version) anchor rods. Thus, you can select the most economical solution based on requirements.
- The large cartridge size of the injection mortar FIS HB is ideally suited for serial installation.
- The pre-portioned resin capsule FHB II-P / PF HIGH SPEED is the economical solution for single applications or under water. A cleaning of the borehole during processing with capsule is not required.
- The special formulation used in the capsule FHB II-PF HIGH SPEED ensures especially fast curing and allows installation without waiting times.

APPLICATIONS

- Guard rails
- Façades
- Staircases
- Steel brackets
- Machines
- Silo installations
- Masts
- Rash protection
- Steelwork constructions
- Timber constructions

FUNCTIONING

- The FHB II is a bonded anchor with torque-controlled expansion for pre-positioned and push-through installation.
- The anchor rod can be set either with injection mortar FIS HB or with the capsule FHB II-P / FHB II-PF HIGH SPEED, and is fully bonded in the drill hole.
- When tightening the hexagon nut, the anchor rod cones are pulled into the mortar shell, which expands against the drill hole wall.
- The styrene-free vinyl ester mortar fully seals the drill hole.
- When using the resin capsule, set the anchor rod through rotating and hitting motions with a hammer drill. The RA-SDS setting tool, item no. 62420 is used.

SEE ALSO



DISPENSER

Page 195



ACCESSORIES

Page 198

INSTALLATION IN CONCRETE WITH CAPSULE FHB II-P

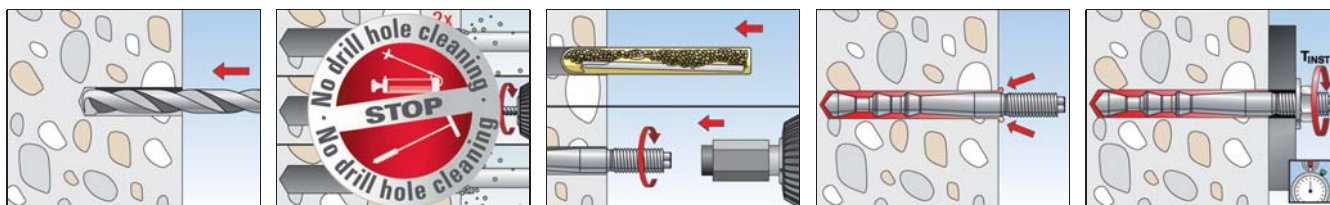

INSTALLATION IN CONCRETE WITH FIS HB

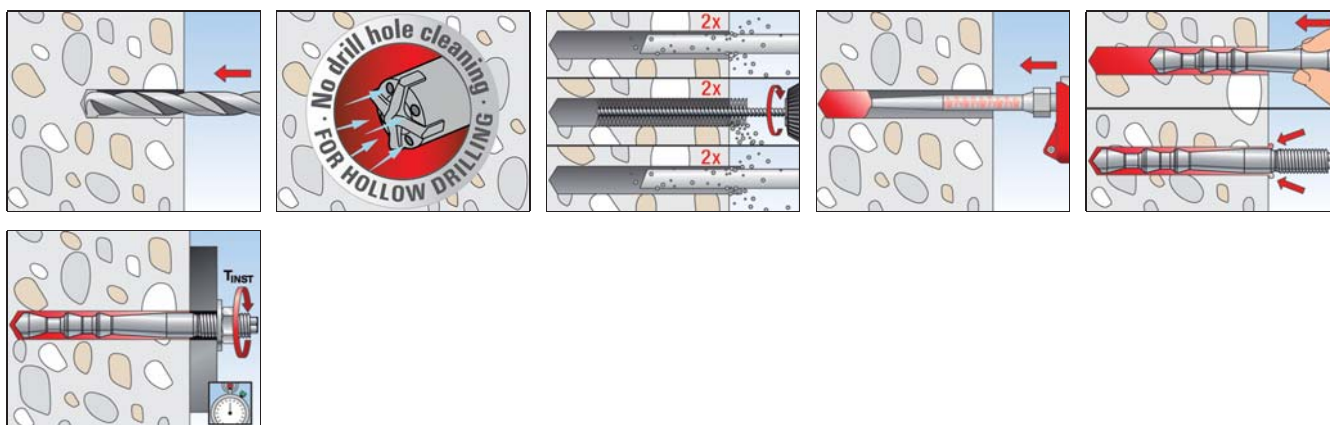

TECHNICAL DATA



Injection mortar **FIS HB 345 S**
+ static mixer **FIS MR Plus**



Injection mortar **FIS HB 150 C**

Item	Art.-No.	Approval ETA	Languages on the cartridge	Scale unit	Contents	Sales unit [pcs]
FIS HB 345 S	033211	■	DE, GB, FR, ES, NL, CS	180	1 cartridge 360 ml, 2 x FIS MR Plus	6
FIS HB 150 C	519665	■	DE, FR, NL	70	1 cartridge 145 ml, 2 x FIS MR Plus	6
FIS MR Plus	545853	-	-	-	10 static mixer FIS MR Plus	10

TECHNICAL DATA



Resin capsule **FHB II-P** (standard)

Item	Art.-No.	Approval ETA	Drill hole diameter d_0 [mm]	Drill hole depth h_0 [mm]	Anchorage depth h_{ef} [mm]	Match	Sales unit [pcs]
FHB II-P 8 x 60	096824	■	10	75	60	FHB II-A L M 8 x 60	10
FHB II-P 10 x 60	096847	■	10	75	60	FHB II-S M 10 x 60	10
FHB II-P 10 x 75	508016	■	10	90	75	FHB II-A S M 10 x 75	10
FHB II-P 10 x 95	096843	■	12	110	95	FHB II-A L M 10 x 95	10
FHB II-P 12 x 75	096848	■	12	90	75	FHB II-A S M 12 x 75	10
FHB II-P 12 x 100	507922	■	14	115	100	FHB II-A L M 12 x 100	10
FHB II-P 12 x 120	096844	■	14	135	120	FHB II-A L M 12 x 120	10
FHB II-P 16 x 95	096849	■	16	110	95	FHB II-S M 16 x 95	10
FHB II-P 16 x 125	507923	■	18	145	125	FHB II-A L M 16 x 125	10
FHB II-P 16 x 145	507924	■	18	165	145	FHB II-A L M 16 x 145	10
FHB II-P 16 x 160	096845	■	18	175	160	FHB II-A L M 16 x 160	10
FHB II-P 20 x 170	507925	■	25	190	170	FHB II-A S M 20 x 170	4
FHB II-P 20 x 210	096846	■	25	235	210	FHB II-A L M 20 x 210	4
FHB II-P 24 x 170	096851	■	25	190	170	FHB II-A S M 24 x 170	4
FHB II-P 24 x 210	507926	■	25	235	210	FHB II-A L M 24 x 210	4

TECHNICAL DATA



Resin capsule **FHB II-PF HIGH SPEED**
(quick version)

Item	Art.-No.	Approval ETA	Drill hole diameter d ₀ [mm]	Drill hole depth h ₀ [mm]	Anchorage depth h _{ef} [mm]	Match	Sales unit [pcs]
FHB II-PF 8 x 60	500542	■	10	75	60	FHB II-A L M 8 x 60	10
FHB II-PF 10 x 60	500547	■	10	75	60	FHB II-S M 10 x 60	10
FHB II-PF 10 x 75	507999	■	10	90	75	FHB II-A S M 10 x 75	10
FHB II-PF 10 x 95	500543	■	12	110	95	FHB II-A L M 10 x 95	10
FHB II-PF 12 x 75	500548	■	12	90	75	FHB II-A S M 12 x 75	10
FHB II-PF 12 x 100	508000	■	14	115	100	FHB II-A L M 12 x 100	10
FHB II-PF 12 x 120	500544	■	14	135	120	FHB II-A L M 12 x 120	10
FHB II-PF 16 x 95	500549	■	16	110	95	FHB II-A S M 16 x 95	10
FHB II-PF 16 x 125	508001	■	18	145	125	FHB II-A L M 16 x 125	10
FHB II-PF 16 x 145	508002	■	18	165	145	FHB II-A L M 16 x 145	10
FHB II-PF 16 x 160	500545	■	18	175	160	FHB II-A L M 16 x 160	10
FHB II-PF 20 x 170	508003	■	25	190	170	FHB II-A S M 20 x 170	4
FHB II-PF 20 x 210	500546	■	25	235	210	FHB II-A L M 20 x 210	4
FHB II-PF 24 x 170	500550	■	25	190	170	FHB II-A S M 24 x 170	4
FHB II-PF 24 x 210	508004	■	25	235	210	FHB II-A L M 24 x 210	4

CURING TIME - FIS HB

Cartridge temperature FIS HB (minimum + 5°C)	Gelling time FIS HB	Temperature at anchoring base	Curing time FIS HB
		- 5°C - ± 0°C	360 min.
		± 0°C - + 5°C	180 min.
+ 5°C - +20°C	15 min.	+ 5°C - +20°C	90 min.
+20°C - +30°C	6 min.	+20°C - +30°C	35 min.
+30°C - +40°C	4 min.	+30°C - +40°C	20 min.
> +40°C	2 min.	> +40°C	12 min.

Please note: The curing times apply for dry anchoring bases, in damp anchoring bases they should be doubled. Remove water from drill hole.

CURING TIME - FHB II P / FHB II-PF HIGH SPEED

Temperature at anchoring base	Curing time	
	FHB II-P	FHB II-PF HIGH SPEED
- 5°C - ± 0°C	240 min.	8 min.
± 0°C - +10°C	45 min.	6 min.
+10°C - + 20°C	20 min.	4 min.
≥ + 20°C	10 min.	2 min.

Please note: The curing times apply for dry anchoring bases, in damp anchoring bases they should be doubled.

TECHNICAL DATA



Highbond anchor **FHB II-A S** (short version)

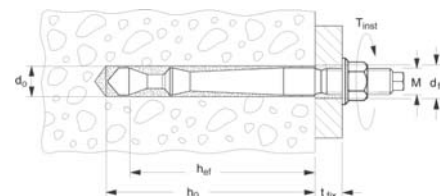

	Zinc-plated steel	Stainless steel	Highly corrosion resistant steel	Approval	Drill hole diameter d ₀ [mm]	Drill hole depth h ₀ [mm]	Anchorage depth h _{ef} [mm]	Usable length t _{fix} [mm]	Thread M	Width across nut [mm]	Sales unit [pcs]
Item	Art.-No. gvz	Art.-No. A4	Art.-No. C	ETA							
FHB II-A S M10 x 60/10	097072	097630	097704 ¹⁾	■	10	75	60	10	M 10	17	10
FHB II-A S M10 x 60/20	097073	097631	—	■	10	75	60	20	M 10	17	10
FHB II-A S M10 x 60/40	—	097632	—	■	10	75	60	40	M 10	17	10

1) Delivery time on request.

TECHNICAL DATA



Highbond anchor **FHB II-A S** (short version)

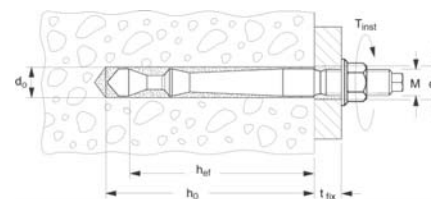

	Zinc-plated steel	Stainless steel	Highly corrosion resistant steel	Approval	Drill hole diameter	Drill hole depth	Anchorage depth	Usable length	Thread	Width across nut	Sales unit
	Art.-No.	Art.-No.	Art.-No.	ETA	d_0	h_0	h_{ef}	t_{fix}	M	○ SW	
Item	gvz	A4	C		[mm]	[mm]	[mm]	[mm]		[mm]	[pcs]
FHB II-A S M10 x 60/60	097074	097633	—	■	10	75	60	60	M 10	17	10
FHB II-A S M10 x 60/100	097206	097634	—	■	10	75	60	100	M 10	17	10
FHB II-A S M10 x 75/10	506884	506888	—	■	10	90	75	10	M 10	17	10
FHB II-A S M10 x 75/20	506885	506889	—	■	10	90	75	20	M 10	17	10
FHB II-A S M10 x 75/40	—	506890	—	■	10	90	75	40	M 10	17	10
FHB II-A S M10 x 75/60	506886	506891	—	■	10	90	75	60	M 10	17	10
FHB II-A S M10 x 75/100	506887	506892	—	■	10	90	75	100	M 10	17	10
FHB II-A S M12 x 75/10	097257	097635	—	■	12	90	75	10	M 12	19	10
FHB II-A S M12 x 75/25	097268	097636	097706 1)	■	12	90	75	25	M 12	19	10
FHB II-A S M12 x 75/40	—	097637	—	■	12	90	75	40	M 12	19	10
FHB II-A S M12 x 75/60	097274	097638	—	■	12	90	75	60	M 12	19	10
FHB II-A S M12 x 75/100	097275	097639	—	■	12	90	75	100	M 12	19	10
FHB II-A S M12 x 75/165	097280	097640	—	■	12	90	75	165	M 12	19	10
FHB II-A S M16 x 95/30	097281	097641	097708 1)	■	16	110	95	30	M 16	24	10
FHB II-A S M16 x 95/60	097286	097642	—	■	16	110	95	60	M 16	24	10
FHB II-A S M16 x 95/100	097295	097643	—	■	16	110	95	100	M 16	24	10
FHB II-A S M16 x 95/165	097296	097644	—	■	16	110	95	165	M 16	24	10
FHB II-A S M20 x 170/50	506917	506919	—	■	25	190	170	50	M 20	30	4
FHB II-A S M24 x 170/50	097297	097645	—	■	25	190	170	50	M 24	36	4

1) Delivery time on request.

TECHNICAL DATA



Highbond anchor **FHB II-A L** (long version)

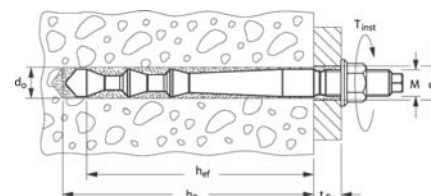

	Zinc-plated steel	Stainless steel	Highly corrosion resistant steel	Approval	Drill hole diameter	Drill hole depth	Anchorage depth	Usable length	Thread	Width across nut	Sales unit
	Art.-No.	Art.-No.	Art.-No.	ETA	d_0	h_0	h_{ef}	t_{fix}	M	○ SW	
Item	gvz	A4	C		[mm]	[mm]	[mm]	[mm]		[mm]	[pcs]
FHB II-A L M8 x 60/10	097032	097298	097696 1)	■	10	75	60	10	M 8	13	10
FHB II-A L M8 x 60/30	097033	097299	—	■	10	75	60	30	M 8	13	10
FHB II-A L M8 x 60/50	097034	097440	—	■	10	75	60	50	M 8	13	10
FHB II-A L M10 x 95/10	096907	097616	—	■	12	110	95	10	M 10	17	10
FHB II-A L M10 x 95/20	096940	097617	097699 1)	■	12	110	95	20	M 10	17	10
FHB II-A L M10 x 95/40	—	097618	—	■	12	110	95	40	M 10	17	10
FHB II-A L M10 x 95/60	096941	097619	—	■	12	110	95	60	M 10	17	10
FHB II-A L M10 x 95/100	096942	097620	—	■	12	110	95	100	M 10	17	10
FHB II-A L M12 x 100/10	506893	506897	—	■	14	115	100	10	M 12	19	10
FHB II-A L M12 x 100/25	506894	506898	—	■	14	115	100	25	M 12	19	10
FHB II-A L M12 x 100/40	—	506899	—	■	14	115	100	40	M 12	19	10
FHB II-A L M12 x 100/50 GS A4	—	537065	—	■	14	115	100	50	M 12	19	10
FHB II-A L M12 x 100/60	506895	506901	—	■	14	115	100	60	M 12	19	10
FHB II-A L M12 x 100/100	506896	506902	—	■	14	115	100	100	M 12	19	10
FHB II-A L M12 x 120/10	096943	097621	—	■	14	135	120	10	M 12	19	10

1) Delivery time on request.

TECHNICAL DATA



Highbond anchor **FHB II-A L** (long version)

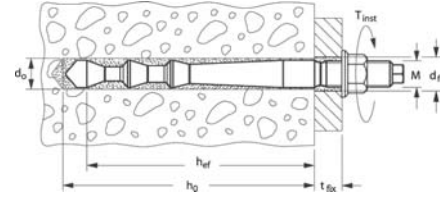

3
Chemical fixings

Item	Zinc-plated steel	Stainless steel	Highly corrosion resistant steel	Approval ETA	Drill hole diameter	Drill hole depth	Anchorage depth	Usable length	Thread	Width across nut	Sales unit
	Art.-No.	Art.-No.	Art.-No.		d_0	h_0	h_{ef}	t_{fix}	M	○ SW	[pcs]
	gvz	A4	C		[mm]	[mm]	[mm]	[mm]		[mm]	
FHB II-A L M12 x 120/25	096944	097622	097700 1)	■	14	135	120	25	M 12	19	10
FHB II-A L M12 x 120/40	—	097623	—	■	14	135	120	40	M 12	19	10
FHB II-A L M12 x 120/60	097014	097624	—	■	14	135	120	60	M 12	19	10
FHB II-A L M12 x 120/100	097031	097625	—	■	14	135	120	100	M 12	19	10
FHB II-A L M16 x 125/30	506903	506906	—	■	18	140	125	30	M 16	24	10
FHB II-A L M16 x 125/60	506904	506909	—	■	18	140	125	60	M 16	24	10
FHB II-A L M16 x 125/100	506905	506910	—	■	18	140	125	100	M 16	24	10
FHB II-A L M16 x 145/30	506911	506914	—	■	18	160	145	30	M 16	24	10
FHB II-A L M16 x 145/60	506912	506915	—	■	18	160	145	60	M 16	24	10
FHB II-A L M16 x 145/100	506913	506916	—	■	18	160	145	100	M 16	24	10
FHB II-A L M16 x 160/30	097035	097626	097702 1)	■	18	175	160	30	M 16	24	10
FHB II-A L M16 x 160/60	097038	097627	—	■	18	175	160	60	M 16	24	10
FHB II-A L M16 x 160/100	097070	097628	—	■	18	175	160	100	M 16	24	10
FHB II-A L M20 x 210/50	097071	097629	097703 1)	■	25	235	210	50	M 20	30	4
FHB II-A L M20 x 210/150	052370	—	—	■	25	235	210	150	M 20	30	8
FHB II-A L M24 x 210/50	506920	506921	—	■	25	235	210	50	M 24	36	4

1) Delivery time on request.

FILLING QUANTITIES

Type	Drill hole diameter	Min. drill hole depth	Mortar volume in scale units shown on the cartridge labels' corresponding scale	Anchor per cartridge FIS HB 345 S ^{*)}
	[mm]	[mm]		
FHB II-A S M10 x 60	10	75	3	56
FHB II-A S M10 x 75	10	90	4	42
FHB II-A S M12 x 75	12	90	4	42
FHB II-A S M16 x 95	16	110	8	21
FHB II-A S M20 x 170	25	190	26	6
FHB II-A S M24 x 170	25	190	26	6

^{*)} max. number with one static mixer

FILLING QUANTITIES

Type	Drill hole diameter	Min. drill hole depth	Mortar volume in scale units shown on the cartridge labels' corresponding scale	Anchor per cartridge FIS HB 345 S ^{*)}
	[mm]	[mm]		
FHB II-A L M8 x 60	10	75	3	56
FHB II-A L M10 x 95	12	110	5	34
FHB II-A L M12 x 100	14	115	7	24
FHB II-A L M12 x 120	14	135	7	24
FHB II-A L M16 x 125	18	140	11	15
FHB II-A L M16 x 145	18	160	13	13
FHB II-A L M16 x 160	18	175	13	13
FHB II-A L M20 x 210	25	235	33	5
FHB II-A L M24 x 210	25	235	33	5

^{*)} max. number with one static mixer

LOADS

Highbond anchor FHB II ¹⁾

zinc plated steel / stainless steel / high corrosion resistant steel

Permissible loads of a single anchor in cracked normal concrete (concrete tension zone) of strength class C20/25 ²⁾³⁾⁴⁾										Minimum spacings while reducing the load	
Type	Material fixing element	Min. member thickness h_{min} [mm]	Effective anchorage depth h_{ef} [mm]	Installation torque T_{inst} [Nm]	Permissible tensile load $N_{perm}^{5)}$ [kN]	Permissible shear load $V_{perm}^{5)}$ [kN]	Required edge distance (with one edge) for		Required spacing for Max. Load s [mm]	Min. spacing $s_{min}^{6)}$ [mm]	Min. edge distance $c_{min}^{6)}$ [mm]
							Max. tension load c [mm]	Max. shear load c [mm]			
FHB II-A L M8 x 60	gvz	100	60	15	8,0 ¹⁾	7,8	150	163	180	40	40
	A4-70							183			
	C-70										
FHB II-A S M10 x 60	gvz	100	60	15	8,0 ¹⁾	11,3	150	245	180	40	40
	A4-70							306			
	C-70										
FHB II-A S M10 x 75	gvz	120	75	15	11,1	11,3	150	215	225	40	40
	A4-70							269			
FHB II-A L M10 x 95	gvz	140	95	20	15,9	11,9	238	197	285	40	40
	A4-70							224			
	C-70										
FHB II-A S M12 x 75	gvz	120	75	30	11,1	15,6	150	304	225	40	40
	A4-70							384			
	C-70										
FHB II-A L M12 x 100	gvz	140	100	40	17,1	17,3	190	296	300	50	50
	A4-70							334			
FHB II-A L M12 x 120	gvz	170	120	40	22,5	17,3	300	259	360	50	50
	A4-70							292			
	C-70										
FHB II-A S M16 x 95	gvz	150	95	50	15,9	29,0	170	506	285	50	50
	A4-70							559			
	C-70										
FHB II-A L M16 x 125	gvz	170	125	60	24,0	32,2	188	505	375	55	55
	A4-70							570			
FHB II-A L M16 x 145	gvz	190	145	60	29,9	32,2	250	464	435	60	60
	A4-70							525			
FHB II-A L M16 x 160	gvz	220	160	60	34,7	32,2	290	423	480	70	70
	A4-70							479			
	C-70										
FHB II-A S M20 x 170	gvz	240	170	100	38,0	45,9	255	571	510	80	80
	A4-70							719			
FHB II-A L M20 x 210	gvz	280	210	100	52,2	50,2	315	563	630	90	90
	A4-70							639			
	C-70										
FHB II-A S M24 x 170	gvz	240	170	100	38,0	65,3	255	857	510	80	80
	A4-70							946			
	C-70							1019			
FHB II-A L M24 x 210	gvz	280	210	100	52,2	72,5	315	863	630	90	90
	A4-70							974			

For the design the complete assessment ETA-05/0164 has to be considered. ⁷⁾

¹⁾ Valid for injection mortar FIS HB. For using the glass capsule FHB II-P or FHB II-PF see ETA-05/0164.

²⁾ The partial safety factors for material resistance as regulated in the ETA-05/0164 as well as a partial safety factor for load actions of $\gamma_L = 1.4$ are considered. As a single anchor counts e.g. an anchor with a spacing $s \geq 3 \cdot h_{ef}$ and an edge distance $c \geq 1.5 \cdot h_{ef}$. Accurate data see ETA-05/0164.

³⁾ For higher concrete strength classes up to C50/60 higher permissible loads may be possible.

⁴⁾ Drill method Hammer drilling.

⁵⁾ For combinations of tensile loads, shear loads, bending moments as well as reduced edge distances or spacings (anchor groups) see ETA-05/0164.

⁶⁾ Minimum possible axial spacings resp. edge distance while reducing the permissible load.

⁷⁾ The given loads refer to the assessment ETA-05/0164, issue date 14/12/2017. Design of the loads according ETAG 001, Annex C, Method A (for static resp. quasi-static loads).

LOADS

Highbond anchor FHB II ¹⁾

zinc plated steel / stainless steel / high corrosion resistant steel

Permissible loads of a single anchor in non-cracked normal concrete (concrete compression zone) of strength class C20/25 ^{2) 3) 4)}										Minimum spacings while reducing the load	
Type	Material fixing element	Min. member thickness h_{min} [mm]	Effective anchorage depth h_{ef} [mm]	Installation torque T_{inst} [Nm]	Permissible tensile load $N_{perm}^{5)}$ [kN]	Permissible shear load $V_{perm}^{5)}$ [kN]	Required edge distance (with one edge) for		Required spacing for Max. Load s [mm]	Min. spacing $s_{min}^{6)}$ [mm]	Min. edge distance $c_{min}^{6)}$ [mm]
							Max. tension load c [mm]	Max. shear load c [mm]			
FHB II-A L M8 x 60	gvz	100	60	15	11,2 ¹⁾	7,8	150	110	180	40	40
	A4-70							124			
	C-70							124			
FHB II-A S M10 x 60	gvz	100	60	15	11,2 ¹⁾	11,3	150	166	180	40	40
	A4-70							209			
	C-70							209			
FHB II-A S M10 x 75	gvz	120	75	15	12,0	11,3	103	145	225	40	40
	A4-70							183			
	C-70							183			
FHB II-A L M10 x 95	gvz	140	95	20	16,4	11,9	139	131	285	40	40
	A4-70							150			
	C-70							150			
FHB II-A S M12 x 75	gvz	120	75	30	15,6	15,6	150	206	225	40	40
	A4-70							261			
	C-70							261			
FHB II-A L M12 x 100	gvz	140	100	40	23,7	17,3	187	198	300	50	50
	A4-70							225			
	C-70							225			
FHB II-A L M12 x 120	gvz	170	120	40	23,7	17,3	179	172	360	50	50
	A4-70							195			
	C-70							195			
FHB II-A S M16 x 95	gvz	150	95	50	22,3	29,0	170	343	285	50	50
	A4-70							435			
	C-70							435			
FHB II-A L M16 x 125	gvz	170	125	60	33,6	32,2	188	339	375	55	55
	A4-70							384			
	C-70							384			
FHB II-A L M16 x 145	gvz	190	145	60	42,0	32,2	250	310	435	60	60
	A4-70							352			
	C-70							352			
FHB II-A L M16 x 160	gvz	220	160	60	46,0	32,2	270	282	480	70	70
	A4-70							321			
	C-70							321			
FHB II-A S M20 x 170	gvz	240	170	100	53,3	45,9	255	380	510	80	80
	A4-70							481			
	C-70							481			
FHB II-A L M20 x 210	gvz	280	210	100	65,5	50,2	273	372	630	90	90
	A4-70							424			
	C-70							424			
FHB II-A S M24 x 170	gvz	240	170	100	53,3	65,3	255	576	510	80	80
	A4-70							637			
	C-70							735			
FHB II-A L M24 x 210	gvz	280	210	100	65,5	72,5	273	578	630	90	90
	A4-70							654			
	C-70							654			

For the design the complete assessment ETA-05/0164 has to be considered. ⁷⁾

¹⁾ Valid for injection mortar FIS HB. For using the glass capsule FHB II-P or FHB II-PF see ETA-05/0164.

²⁾ The partial safety factors for material resistance as regulated in the ETA-05/0164 as well as a partial safety factor for load actions of $\gamma_L = 1.4$ are considered. As an single anchor counts e.g. an anchor with a spacing $s \geq 3 \cdot h_{ef}$ and an edge distance $c \geq 1.5 \cdot h_{ef}$. Accurate data see ETA-05/0164.

³⁾ For higher concrete strength classes up to C50/60 higher permissible loads may be possible.

⁴⁾ Drill method Hammer drilling.

⁵⁾ For combinations of tensile loads, shear loads, bending moments as well as reduced edge distances or spacings (anchor groups) see ETA-05/0164.

⁶⁾ Minimum possible axial spacings resp. edge distance while reducing the permissible load.

⁷⁾ The given loads refer to the assessment ETA-05/0164, issue date 14/12/2017. Design of the loads according ETAG 001, Annex C, Method A (for static resp. quasi-static loads).

The economical solution in cracked concrete



Bridge railings

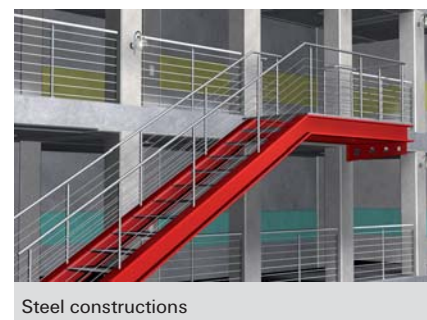

Steel constructions

VERSIONS

- Stainless steel A4

BUILDING MATERIALS

Approved for:

- Concrete C20/25 to C50/60, cracked and non-cracked

Also suitable for:

- Concrete C12/15

CERTIFICATES



ADVANTAGES

- The Highbond system FHB II Inject achieves high load values in cracked concrete.
- The combination of injection mortar FIS HB and anchor rod FHB II-AS Inject A4 (short version) or FHB II-AL Inject A4 (long version) is ideally suited for serial installation outdoors.
- The low drill hole depth minimizes the drilling effort, which saves time and ensures economical installation.
- When using hollow drills with extraction, no drill hole cleaning is required.

APPLICATIONS

- Bridge railings
- Façades
- Staircases
- Steel constructions
- Masts

FUNCTIONING

- The FHB II Inject is a bonded anchor with torque-controlled expansion for pre-positioned and push-through installation.
- For FHB II-AL Inject, the annular gap must be filled with Highbond special mortar FIS HB in case of push-through installation.
- The anchor rod is set with the Highbond special motor FIS HB and is fully bonded in the drill hole.
- When tightening the hexagon nut, the anchor rod cones are pulled in the motor shell, which expands against the drill hole wall.

SEE ALSO



DISPENSER
Page 195



ACCESSORIES
Page 198

INSTALLATION IN CONCRETE WITH FIS HB

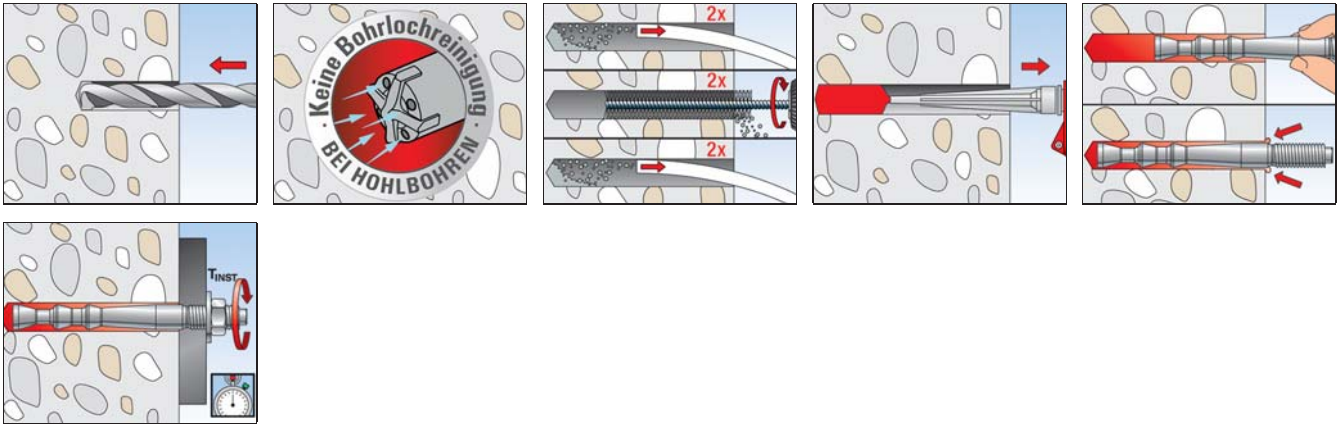

TECHNICAL DATA



Injection mortar **FIS HB 345 S**
+ static mixer **FIS MR Plus**



Injection mortar **FIS HB 150 C**

Item	Art.-No.	Approval ETA	Languages on the cartridge	Scale unit	Contents	Sales unit [pcs]
FIS HB 345 S	033211	■	DE, GB, FR, ES, NL, CS	180	1 cartridge 360 ml, 2 x FIS MR Plus	6
FIS HB 150 C	519665	■	DE, FR, NL	70	1 cartridge 145 ml, 2 x FIS MR Plus	6
FIS MR Plus	545853	-	-	-	10 static mixer FIS MR Plus	10

CURING TIME - FIS HB

Cartridge temperature FIS HB (minimum + 5°C)	Gelling time FIS HB	Temperature at anchoring base	Curing time FIS HB
		- 5°C - ± 0°C	360 min.
		± 0°C - + 5°C	180 min.
+ 5°C - +20°C	15 min.	+ 5°C - +20°C	90 min.
+20°C - +30°C	6 min.	+20°C - +30°C	35 min.
+30°C - +40°C	4 min.	+30°C - +40°C	20 min.
> +40°C	2 min.	> +40°C	12 min.

Please note: The curing times apply for dry anchoring bases, in damp anchoring bases they should be doubled. Remove water from drill hole.

TECHNICAL DATA



Highbond anchor **FHB II-A S Inject**
(short version)

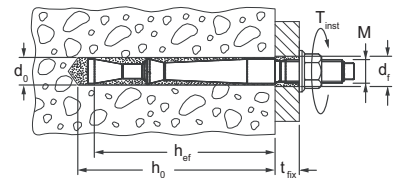

Item	Stainless steel Art.-No.	Approval ETA	Drill hole diameter d ₀ [mm]	Drill hole depth h ₀ [mm]	Anchorage depth h _{ef} [mm]	Total length l [mm]	Usable length t _{fix} [mm]	Width across nut ○ SW [mm]	Sales unit [pcs]
FHB II-A S Inject M10 x 60/10	539911	■	10	66	60	90	10	17	10
FHB II-A S Inject M10 x 60/20	539912	■	10	66	60	100	20	17	10
FHB II-A S Inject M10 x 60/30	539927	■	10	66	60	110	30	17	10
FHB II-A S Inject M10 x 60/40	539913	■	10	66	60	120	40	17	10
FHB II-A S Inject M10 x 60/100	539914	■	10	66	60	180	100	17	10
FHB II-A S Inject M12 x 75/25	539928	■	12	81	75	123	25	19	10
FHB II-A S Inject M12 x 75/50	539929	■	12	81	75	148	50	19	10

TECHNICAL DATA



Highbond anchor **FHB II-A S Inject**
(short version)

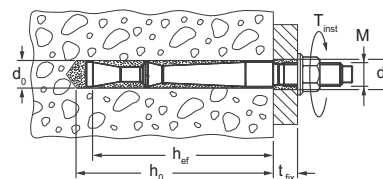

	Stainless steel	Approval	Drill hole diameter	Drill hole depth	Anchorage depth	Total length	Usable length	Width across nut	Sales unit
	Art.-No.	ETA	d_0 [mm]	h_0 [mm]	h_{ef} [mm]	l [mm]	t_{fix} [mm]	○SW [mm]	[pcs]
Item	A4								
FHB II-A S Inject M16 x 95/30	539920	■	16	101	95	150	30	24	10
FHB II-A S Inject M16 x 95/60	539921	■	16	101	95	180	60	24	10

TECHNICAL DATA



Highbond anchor **FHB II-A L Inject**
(long version)

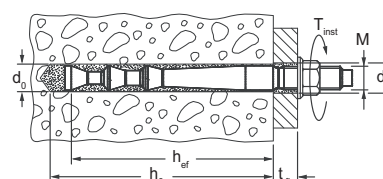

	Stainless steel	Approval	Drill hole diameter	Drill hole depth	Anchorage depth	Total length	Usable length	Width across nut	Sales unit
	Art.-No.	ETA	d_0 [mm]	h_0 [mm]	h_{ef} [mm]	l [mm]	t_{fix} [mm]	○SW [mm]	[pcs]
Item	A4								
FHB II-A L Inject M10 x 95/10	539916	■	12	101	95	125	10	17	10
FHB II-A L Inject M10 x 95/20	539917	■	12	101	95	135	20	17	10
FHB II-A L Inject M12 x 100/25	539918	■	14	106	100	148	25	19	10
FHB II-A L Inject M12 x 120/25	539919	■	14	126	120	160	25	19	10
FHB II-A L Inject M16 x 125/30	539922	■	18	131	125	180	30	24	10
FHB II-A L Inject M16 x 125/60	539923	■	18	131	125	210	60	24	10
FHB II-A L Inject M16 x 160/30	539925	■	18	166	160	215	30	24	10
FHB II-A L Inject M16 x 160/60	539926	■	18	166	160	245	60	24	10

FILLING QUANTITIES FHB II-A S INJECT

Type	Drill hole diameter	Min. drill hole depth	Mortar volume in scale units shown on the cartridge labels' corresponding scale	Anchor per cartridge FIS HB 345 S *)
	[mm]	[mm]		
FHB II-A S Inject M10 x 60	10	75	3	56
FHB II-A S Inject M12 x 75	12	90	4	42
FHB II-A S Inject M16 x 95	16	110	8	21

*) max. number with one static mixer

FILLING QUANTITIES FHB II-A L INJECT

Type	Drill hole diameter	Min. drill hole depth	Mortar volume in scale units shown on the cartridge labels' corresponding scale	Anchor per cartridge FIS HB 345 S *)
	[mm]	[mm]		
FHB II-A L Inject M10 x 95	12	110	5	34
FHB II-A L Inject M12 x 100	14	115	6	24
FHB II-A L Inject M12 x 120	14	135	7	24
FHB II-A L Inject M16 x 125	18	140	11	15
FHB II-A L Inject M16 x 160	18	175	13	13

*) max. number with one static mixer

LOADS

Highbond anchor FHB II Inject: Injection mortar FIS HB with Anchor rod FHB II-A Inject
stainless steel A4

Permissible loads of a single anchor in cracked normal concrete (concrete tension zone) of strength class C20/25 (~B25) ^{1) 2) 3) 7)}										Minimum spacings while reducing the load	
Type	Material fixing element	Min. member thickness h_{min} [mm]	Effective anchorage depth h_{ef} [mm]	Installation torque T_{inst} [Nm]	Permissible tensile load $N_{perm}^{4)}$ [kN]	Permissible shear load $V_{perm}^{4)}$ [kN]	Required edge distance (with one edge) for		Required spacing for Max. Load s_{cr} [mm]	Min. spacing $s_{min}^{5)}$ [mm]	Min. edge distance $c_{min}^{5)}$ [mm]
							Max. tension load c [mm]	Max. shear load c [mm]			
FHB II-A S Inject M10 x 60	A4	100	60	15	8,0	13,8	90	310	180	40	40
FHB II-A L Inject M10 x 95	A4	140	95	20	15,9	13,3	145	225	285	40	40
FHB II-A S Inject M12 x 75	A4	120	75	30	11,1	19,3	115	385	225	40	40
FHB II-A L Inject M12 x 100	A4	140	100	40	17,1	19,3	150	335	300	50	50
FHB II-A L Inject M12 x 120	A4	170	120	40	22,5	19,3	180	295	360	50	50
FHB II-A S Inject M16 x 95	A4	150	95	50	15,9	31,7	145	560	285	50	50
FHB II-A L Inject M16 x 125	A4	170	125	60	24,0	35,8	190	570	375	55	55
FHB II-A L Inject M16 x 160	A4	220	160	60	34,7	35,8	240	480	480	70	70

For the design the complete assessment ETA-16/0637 has to be considered. ⁶⁾

¹⁾ The partial safety factors for material resistance as regulated in the ETA-16/0637 as well as a partial safety factor for load actions of $\gamma_L = 1,4$ are considered. As a single anchor counts e.g. an anchor with a spacing $s \geq 3 \cdot h_{ef}$ and an edge distance $c \geq 1,5 \cdot h_{ef}$. Accurate data see ETA-16/0637.

²⁾ For higher concrete strength classes up to C50/60 higher permissible loads may be possible.

³⁾ Drill method hammer drilling.

⁴⁾ For combinations of tensile loads and shear loads or for shear loads with lever arm (bending moments) as well as reduced edge distances or spacings (anchor groups) we recommend to use our anchor design software C-FIX.

⁵⁾ Minimum possible axial spacings resp. edge distance while reducing the permissible load.

⁶⁾ The given loads refer to the European Technical Assessment ETA-16/0637, issue date 14/12/2017. Design of the loads according to ETAG 001, Annex C, Method A (for static resp. quasi-static loads).

⁷⁾ A reinforcement in the concrete to prevent splitting is required. The width of the cracks has to be limited under consideration of the splitting forces at $w_k \sim 0,3$ mm.

LOADS

Highbond anchor FHB II Inject: Injection mortar FIS HB with Anchor rod FHB II-A Inject
stainless steel A4

Permissible loads of a single anchor in non-cracked normal concrete (concrete compression zone) of strength class C20/25 (~B25) ¹⁾²⁾³⁾										Minimum spacings while reducing the load	
Type	Material fixing element	Min. member thickness h_{min} [mm]	Effective anchorage depth h_{ef} [mm]	Installation torque T_{inst} [Nm]	Permissible tensile load $N_{perm}^{4)}$ [kN]	Permissible shear load $V_{perm}^{4)}$ [kN]	Required edge distance (with one edge) for		Required spacing for Max. Load s_{cr} [mm]	Min. spacing $s_{min}^{5)}$ [mm]	Min. edge distance $c_{min}^{5)}$ [mm]
							Max. tension load c [mm]	Max. shear load c [mm]			
FHB II-A S Inject M10 x 60	A4	100	60	15	11,2	13,8	150	210	180	40	40
FHB II-A L Inject M10 x 95	A4	140	95	20	16,4	13,3	140	150	285	40	40
FHB II-A S Inject M12 x 75	A4	120	75	30	15,6	19,3	150	265	225	40	40
FHB II-A L Inject M12 x 100	A4	140	100	40	23,7	19,3	190	225	300	50	50
FHB II-A L Inject M12 x 120	A4	170	120	40	23,7	19,3	180	195	360	50	50
FHB II-A S Inject M16 x 95	A4	150	95	50	22,3	35,8	170	435	285	50	50
FHB II-A L Inject M16 x 125	A4	170	125	60	33,6	35,8	190	385	375	55	55
FHB II-A L Inject M16 x 160	A4	220	160	60	46,0	35,8	270	325	480	70	70

For the design the complete assessment ETA-16/0637 has to be considered. ⁶⁾

¹⁾ The partial safety factors for material resistance as regulated in the ETA-16/0637 as well as a partial safety factor for load actions of $\gamma_L = 1,4$ are considered. As a single anchor counts e.g. an anchor with a spacing $s \geq 3 \cdot h_{ef}$ and an edge distance $c \geq 1,5 \cdot h_{ef}$. Accurate data see ETA-16/0637.

²⁾ For higher concrete strength classes up to C50/60 higher permissible loads may be possible.

³⁾ Drill method hammer drilling.

⁴⁾ For combinations of tensile loads and shear loads or for shear loads with lever arm (bending moments) as well as reduced edge distances or spacings (anchor groups) we recommend to use our anchor design software C-FIX.

⁵⁾ Minimum possible axial spacings resp. edge distance while reducing the permissible load.

⁶⁾ The given loads refer to the European Technical Assessment ETA-16/0637, issue date 14/12/2017. Design of the loads according to ETAG 001, Annex C, Method A (for static resp. quasi-static loads).

The concrete all-rounder







3
Chemical fixings



BUILDING MATERIALS

- Approved for anchorings in:**
- Concrete C20/25 to C50/60, cracked and non-cracked
- Also suitable for:**
- Natural stone with dense structure

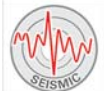
CERTIFICATES

  ETA-12/0258 ETAG 001-5 Option 1 for cracked concrete Seismic performance category C1, C2	  ETA-13/0651 ETAG 001-5 Post-installed rebar connection (TR23)
 Fire resistance classification R 120 Anchor types see test report	 SEISMIC
 ESR-3572	See ICC-ES Evaluation Report at www.icc-es.org

ADVANTAGES

- The Superbond system is a combined capsule and injection system for cracked and non-cracked concrete. The injection mortar FIS SB and resin capsule RSB perform the same as each other at the same anchorage depth. This gives the installer maximum flexibility.
- Variable anchorage depths from $4 \times d_s$ to $20 \times d_s$ enable ideal adaptation to the load to be applied, and thus ensure an optimised installation time and use of materials.
- Maximum application temperatures of up to $+150\text{ °C}$ open up new areas of use for bonded anchors.
- Superbond is even approved for installation at frosty temperatures of -30 °C .
- The approval-compliant use for seismic applications (performance category C1, C2) as well as in waterfilled and diamond drill holes ensures safety even in extreme conditions.



APPLICATIONS

- Heavy steel constructions
- Silo installations
- Tall shelving
- Sound barriers
- Guard rails
- Staircases
- Reinforcing steel (only FIS SB)
- Overhead installations
- Water-filled drill holes
- Diamond drilled holes

FUNCTIONING

- Superbond is a bonded anchor system based on a vinyl ester hybrid with silane technology.
- The threaded rod FIS A can only be set with injection mortar FIS SB (Standard and HIGH SPEED); the threaded rod RG M with oblique edge can be optionally set with injection mortar FIS SB (Standard and HIGH SPEED) or resin capsule RSB.
- Resin and hardener are stored in two separate chambers and are not mixed and activated until extrusion through the injection cartridge in the static mixer or destruction of the capsule during the setting procedure.
- The mortar bonds the entire surface of the fastening element with the drill hole wall and seals the drill hole.

SEE ALSO

 <p>ANCHORS + SLEEVES Page 144</p>	 <p>DISPENSER Page 195</p>	 <p>ACCESSORIES Page 198</p>
--	--	--

INSTALLATION IN CONCRETE WITH FIS SB AND FIS A / RG M

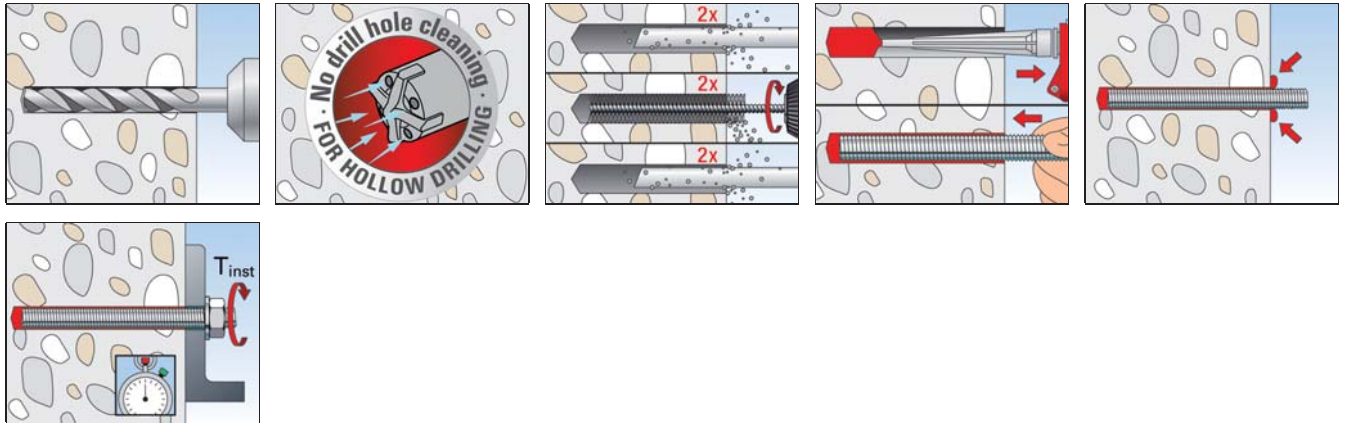

INSTALLATION IN CONCRETE WITH FIS SB AND RG M I

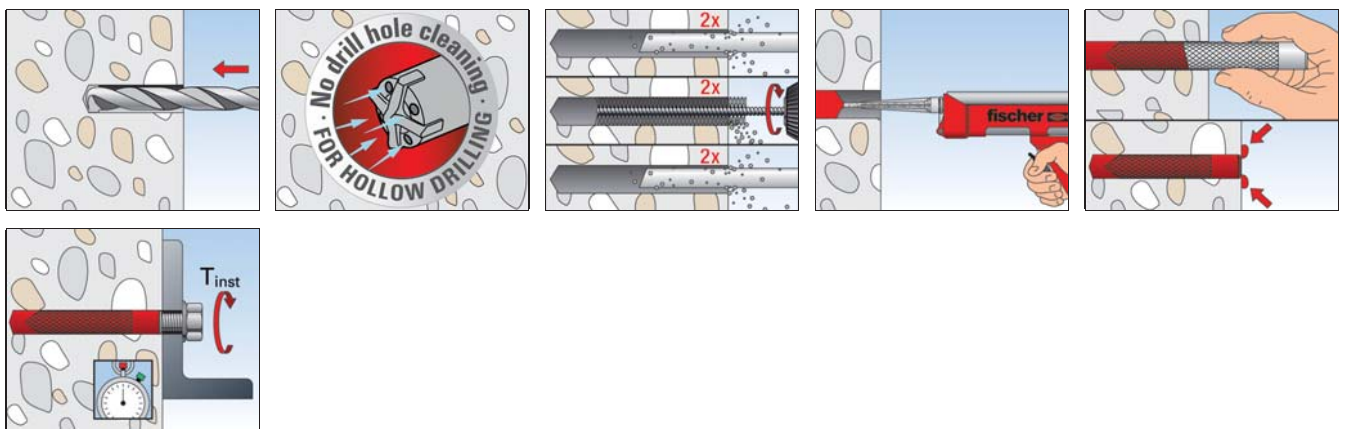

TECHNICAL DATA



Superbond mortar
FIS SB 390 S



Static mixer **FIS MR Plus**

Item	Art.-No.	Approval		Languages on the cartridge	Scale unit	Contents	Sales unit [pcs]
		ETA	ICC				
FIS SB 390 S	519451	■	▲	DE, FR, NL	180	1 cartridge 390 ml, 2 x FIS MR Plus	6
FIS SB 390 S	520557	■	▲	DE, SL, SR, BG	180	1 cartridge 390 ml, 2 x FIS MR Plus	6
FIS SB 390 S	518831	■	▲	EN, ES, PT	180	1 cartridge 390 ml, 2 x FIS MR Plus	6
FIS SB 390 S	519450	■	▲	IT, EN, DE	180	1 cartridge 390 ml, 2 x FIS MR Plus	6
FIS SB 390 S	520559	■	▲	DA, SV, NO, FI	180	1 cartridge 390 ml, 2 x FIS MR Plus	6
FIS SB 390 S	520555	■	▲	CS, SK, RO	180	1 cartridge 390 ml, 2 x FIS MR Plus	6
FIS SB 390 S	520595	■	▲	PL, RU, HU	180	1 cartridge 390 ml, 2 x FIS MR Plus	6
FIS SB 585 S	519452	■	▲	EN, ES, PT	270	1 cartridge 585 ml + 2 x FIS UMR	6
FIS SB 585 S	520526	■	▲	IT, EN, DE	270	1 cartridge 585 ml + 2 x FIS UMR	6
FIS SB HIGH SPEED 390 S	523303	■	—	PL, RUS, HU	180	1 cartridge 390 ml, 2 x FIS MR Plus	6
FIS MR Plus	545853	—	—	—	—	10 static mixer FIS MR Plus	10
FIS UMR	520593	—	—	—	—	10 static mixer FIS UMR for 585 ml and 1500 ml cartridges	10



FIS SB 390 S HWK big

FIS SB 390 S in bucket

Item	Art.-No.	Approval		Languages on the cartridge	Contents	Sales unit
		ETA	ICC			
FIS SB 390 S HWK big	540252	■	▲	EN, ES, PT	20 cartridges 390 ml, 40 x FIS MR Plus	1
FIS SB 390 S HWK big	520573	■	▲	IT, EN, DE	20 cartridges 390 ml, 20 x FIS MR Plus	1
FIS SB 390 S in bucket	540750	■	▲	EN, ES, PT	18 cartridges 390 ml, 36 x FIS MR Plus	1

GELLING AND CURING TIME

Temperature at anchoring base	Gelling time		Curing time	
	FIS SB Standard	FIS SB HIGH SPEED	FIS SB Standard	FIS SB HIGH SPEED
> -20°C - -15°C	-	60 min.	-	24 hrs.
> -15°C - -10°C	60 min.	30 min.	36 hrs.	8 hrs.
> -10°C - -5°C	30 min.	15 min.	24 hrs.	180 min.
> -5°C - ±0°C	20 min.	10 min.	8 hrs.	120 min.
> ±0°C - +5°C	13 min.	5 min.	4 hrs.	60 min.
> +5°C - +10°C	9 min.	3 min.	120 min.	45 min.
> +10°C - +20°C	5 min.	2 min.	60 min.	30 min.
> +20°C - +30°C	4 min.	1 min.	45 min.	15 min.
> +30°C - +40°C	2 min.	-	30 min.	-

LOADS

Superbond-System: Injection mortar FIS SB with Threaded rod FIS A ¹⁾²⁾

zinc plated steel 5.8 / zinc plated steel 8.8 / stainless steel A4-70 / high corrosion resistant steel C-70

Permissible loads of a single anchor in cracked normal concrete (concrete tension zone) of strength class C20/25 (~B25) ³⁾⁴⁾⁵⁾⁶⁾¹¹⁾										Minimum spacings while reducing the load	
Type	Material fixing element	Min. member thickness	Effective anchorage depth	Maximum torque moment	Permissible tensile load	Permissible shear load	Required edge distance (with one edge) for		Required spacing for	Min. spacing	Min. edge distance
							Max. tension load c	Max. shear load c			
		h _{min} [mm]	h _{ef} ⁷⁾ [mm]	T _{max} [Nm]	N _{perm} ⁸⁾ [kN]	V _{perm} ⁸⁾ [kN]	[mm]	[mm]	[mm]	[mm]	[mm]
FIS A M 8	5.8	100	60	10	4,3	5,1	90	105	180	40	40
		110	80		5,7		105	95	240		
		190	160		9,0		75	80	480		
	8.8	100	60		4,3	8,6	90	185	180		
		110	80		5,7		105	170	240		
		190	160		11,5		115	480			
	A4-70	100	60		4,3	6,0	90	125	180		
		110	80		5,7		105	115	240		
		190	160		9,9		85	90	480		
	C-70	100	60		4,3	7,4	90	160	180		
		110	80		5,7		105	145	240		
		190	160		11,5		105	105	480		

LOADS

Superbond-System: Injection mortar FIS SB with Threaded rod FIS A ^{1) 2)}

zinc plated steel 5.8 / zinc plated steel 8.8 / stainless steel A4-70 / high corrosion resistant steel C-70

Permissible loads of a single anchor in cracked normal concrete (concrete tension zone) of strength class C20/25 (~B25) ^{3) 4) 5) 6) 11)}										Minimum spacings while reducing the load					
Type	Material fixing element	Min. member thickness	Effective anchorage depth	Maximum torque moment	Permissible tensile load	Permissible shear load	Required edge distance (with one edge) for		Required spacing for	Min. spacing	Min. edge distance				
							Max. tension load c	Max. shear load c				Max. Load s _{cr}	s _{min} ⁹⁾	c _{min} ⁹⁾	
		h _{min} [mm]	h _{ef} ⁷⁾ [mm]	T _{max} [Nm]	N _{perm} ⁸⁾ [kN]	V _{perm} ⁸⁾ [kN]	[mm]	[mm]	[mm]	[mm]	[mm]				
FIS A M 10	5.8	100	60	20	5,8	8,6	90	185	180	45	45				
		120	90		8,8		130	155	270						
		230	200		13,8		80	110	600						
	8.8	100	60		5,8	11,7	90	255	180						
		120	90		8,8	13,1	130	250	270						
		230	200		19,4		150	600							
	A4-70	100	60		5,8		9,2	90	195			180			
		120	90		8,8	130		165	270						
		230	200		15,7	95		115	600						
	C-70	100	60		5,8	11,4	90	250	180						
		120	90		8,8		130	215	270						
		230	200		19,4			135	600						
FIS A M 12	5.8	100	70	40	9,4	12,0	105	255	210	55	55				
		140	110		14,8		155	195	330						
		270	240		20,5		75	135	720						
	8.8	100	70		9,4	18,8	105	420	210						
		140	110		14,8	19,4	155	340	330						
		270	240		32,3		200	720							
	A4-70	100	70		9,4		13,7	105	295			210			
		140	110		14,8	155		230	330						
		270	240		22,5	90		150	720						
	C-70	100	70		9,4	17,1	105	380	210						
		140	110		14,8		155	295	330						
		270	240		28,1		130	175	720						
	FIS A M 16	5.8	120		80	60	12,3	22,3	120			445	240	65	65
			170		125		22,4		190			350	375		
			360		320		37,6		115			195	960		
8.8		120	80	12,3	24,5		120	495	240						
		170	125	22,4	36,0		190	600	375						
		360	320	57,4			210	320	960						
A4-70		120	80	12,3			24,5	120	495	240					
		170	125	22,4	25,2		190	400	375						
		360	320	42,0			135	215	960						
C-70		120	80	12,3			24,5	120	495	240					
		170	125	22,4	31,4		190	515	375						
		360	320	52,4			270	960							
FIS A M 20		5.8	140	90			120	14,6	29,3	135	530	270	85		
			220	170	38,0			255		455	510				
			450	400	58,6			140		260	1200				
	8.8	140	90	14,6	29,3	135		530	270						
		220	170	38,0	56,0	255		780	510						
		450	400	89,8		320		435	1200						
	A4-70	140	90	14,6		29,3		135	530	270					
		220	170	38,0	39,4	255		520	510						
		450	400	65,7		170		285	1200						
	C-70	140	90	14,6		29,3		135	530	270					
		220	170	38,0	49,1	255		675	510						
		450	400	81,9		265		370	1200						

LOADS

Superbond-System: Injection mortar FIS SB with Threaded rod FIS A ¹⁾²⁾

zinc plated steel 5.8 / zinc plated steel 8.8 / stainless steel A4-70 / high corrosion resistant steel C-70

Permissible loads of a single anchor in cracked normal concrete (concrete tension zone) of strength class C20/25 (~B25) ³⁾⁴⁾⁵⁾⁶⁾¹¹⁾										Minimum spacings while reducing the load	
Type	Material fixing element	Min. member thickness	Effective anchorage depth	Maximum torque moment	Permissible tensile load	Permissible shear load	Required edge distance (with one edge) for		Required spacing for	Min. spacing	Min. edge distance
		h_{min} [mm]	$h_{ef}^{7)}$ [mm]	T_{max} [Nm]	$N_{perm}^{8)}$ [kN]	$V_{perm}^{8)}$ [kN]	Max. tension load c [mm]	Max. shear load c [mm]	Max. Load s_{cr} [mm]		
FIS A M 24	5.8	160	96	150	16,1	32,2	145	545	290	105	105
		270	210		52,2	50,9	315	590	630		
		540	480		84,3		160	330	1440		
	8.8	160	96		16,1	32,2	145	545	290		
		270	210		52,2	80,6	315	1005	630		
		540	480		129,3		450	570	1440		
	A4-70	160	96		16,1	32,2	145	545	290		
		270	210		52,2	56,8	315	670	630		
		540	480		94,3		230	360	1440		
	C-70	160	96		16,1	32,2	145	545	290		
		270	210		52,2	70,9	315	870	630		
		540	480		117,6		380	480	1440		
FIS A M 27	5.8	170	108	200	19,2	38,5	165	610	325	120	120
		310	250		67,8	65,7	375	695	750		
		600	540		109,5		240	390	1620		
	8.8	170	108		19,2	38,5	165	610	325		
		310	250		67,8	105,1	375	1200	750		
		600	540		152,7		495	700	1620		
	A4-70	170	108		19,2	38,5	165	610	325		
		310	250		67,8	73,7	375	795	750		
		600	540		123,0		325	445	1620		
	C-70	170	108		19,2	38,5	165	610	325		
		310	250		67,8	92,0	375	1030	750		
		600	540		152,7		495	595	1620		
FIS A M 30	5.8	190	120	300	22,5	45,1	180	665	360	140	140
		350	280		80,3	80,6	420	795	840		
		670	600		133,8		300	440	1800		
	8.8	190	120		22,5	45,1	180	665	360		
		350	280		80,3	128,6	420	1375	840		
		670	600		188,5		600	805	1800		
	A4-70	190	120		22,5	45,1	180	665	360		
		350	280		80,3	90,2	420	910	840		
		670	600		150,1		395	510	1800		
	C-70	190	120		22,5	45,1	180	665	360		
		350	280		80,3	112,6	420	1180	840		
		670	600		187,1		595	680	1800		

For the design the complete assessment ETA-12/0258 has to be considered. ¹⁰⁾

¹⁾ Also valid for threaded rod RG M in the same property class.

²⁾ Valid for injection mortar FIS SB. For using the glass capsule RSB see separate table resp. ETA-12/0258.

³⁾ The partial safety factors for material resistance as regulated in the ETA-12/0258 as well as a partial safety factor for load actions of $\gamma_L = 1,4$ are considered. As a single anchor counts e.g. an anchor with a spacing $s \geq 3 \cdot h_{ef}$ and an edge distance $c \geq 1,5 \cdot h_{ef}$. Accurate data see ETA-12/0258.

⁴⁾ The given loads are valid for injection mortar FIS SB for fixations in dry and humid concrete for temperatures in the substrate up to 50 °C (resp. short term up to 80 °C. For drill hole cleaning see ETA-12/0258.

⁵⁾ For higher concrete strength classes up to C50/60 higher permissible loads may be possible.

⁶⁾ Drill method hammer drilling.

⁷⁾ For the sizes M8 - M30 the min. anchorage depth and the max. anchorage depth are given. The anchorage depth can be chosen freely between these borders.

⁸⁾ For combinations of tensile loads and shear loads or for shear loads with lever arm (bending moments) as well as reduced edge distances or spacings (anchor groups) we recommend to use our anchor design software C-FIX.

⁹⁾ Minimum possible axial spacings resp. edge distance while reducing the permissible load.

¹⁰⁾ The given loads refer to the European Technical Assessment ETA-12/0258, issue date 19.05.2016. Design of the loads according ETAG 001, Technical Report TR 029 (for static resp. quasi-static loads).

¹¹⁾ A reinforcement in the concrete to prevent splitting is required. The width of the cracks has to be limited under consideration of the splitting forces at $w_k \sim 0,3$ mm.

LOADS

Superbond-System: Injection mortar FIS SB with Threaded rod FIS A ¹⁾²⁾

zinc plated steel 5.8 / zinc plated steel 8.8 / stainless steel A4-70 / high corrosion resistant steel C-70

Permissible loads of a single anchor in non-cracked normal concrete (concrete compression zone) of strength class C20/25 (~B25) ³⁾⁴⁾⁵⁾⁶⁾										Minimum spacings while reducing the load	
Type	Material fixing element	Min. member thickness	Effective anchorage depth	Maximum torque moment	Permissible tensile load	Permissible shear load	Required edge distance (with one edge) for		Required spacing for	Min. spacing	Min. edge distance
							Max. tension load c	Max. shear load c			
		h _{min} [mm]	h _{ef} ⁷⁾ [mm]	T _{max} [Nm]	N _{perm} ⁸⁾ [kN]	V _{perm} ⁸⁾ [kN]	[mm]	[mm]	[mm]	[mm]	[mm]
FIS A M 8	5.8	100	60	10	8,6	5,1	90	70	180	40	40
		110	80		9,0		75		240		
		190	160		40		60		480		
	8.8	100	60		8,6	8,6	90	130	180		
		110	80		11,5		105	115	240		
		190	160		14,3		50	90	480		
	A4-70	100	60		8,6	6,0	90	85	180		
		110	80		9,9		85	75	240		
		190	160		40		70	480			
	C-70	100	60		8,6	7,4	90	110	180		
		110	80		11,5		105	100	240		
		190	160		12,4		40	80	480		
FIS A M 10	5.8	100	60	20	10,8	8,6	95	125	180	45	45
		120	90		13,8		110	105	270		
		230	200		45		85	600			
	8.8	100	60		10,8	13,1	95	200	180		
		120	90		16,2		145	170	270		
		230	200		22,4		60	115	600		
	A4-70	100	60		10,8	9,2	95	135	180		
		120	90		15,7		140	110	270		
		230	200		45		90	600			
	C-70	100	60		10,8	11,4	95	170	180		
		120	90		16,2		145	145	270		
		230	200		19,5		45	105	600		
FIS A M 12	5.8	100	70	40	14,1	12,0	145	175	210	55	55
		140	110		20,5		165	130	330		
		270	240		55		100	720			
	8.8	100	70		14,1	19,4	145	295	210		
		140	110		23,7		205	230	330		
		270	240		32,4		75	150	720		
	A4-70	100	70		14,1	13,7	145	200	210		
		140	110		22,5		190	155	330		
		270	240		55		115	720			
	C-70	100	70		14,1	17,1	145	260	210		
		140	110		23,7		205	200	330		
		270	240		28,1		55	135	720		
FIS A M 16	5.8	120	80	60	17,2	22,3	160	305	240	65	65
		170	125		33,6		285	235	375		
		360	320		37,6		65	150	960		
	8.8	120	80		17,2	34,4	160	495	240		
		170	125		33,6		285	405	375		
		360	320		60,0		120	220	960		
	A4-70	120	80		17,2	25,2	160	350	240		
		170	125		33,6		285	270	375		
		360	320		42,0		65	165	960		
	C-70	120	80		17,2	31,4	160	445	240		
		170	125		33,6		285	350	375		
		360	320		52,4		70	195	960		

LOADS

Superbond-System: Injection mortar FIS SB with Threaded rod FIS A ¹⁾²⁾

zinc plated steel 5.8 / zinc plated steel 8.8 / stainless steel A4-70 / high corrosion resistant steel C-70

Permissible loads of a single anchor in non-cracked normal concrete (concrete compression zone) of strength class C20/25 (~B25) ³⁾⁴⁾⁵⁾⁶⁾										Minimum spacings while reducing the load		
Type	Material fixing element	Min. member thickness	Effective anchorage depth	Maximum torque moment	Permissible tensile load	Permissible shear load	Required edge distance (with one edge) for		Required spacing for	Min. spacing	Min. edge distance	
							Max. tension load c	Max. shear load c				Max. Load s _{cr}
		h _{min} [mm]	h _{ef} ⁷⁾ [mm]	T _{max} [Nm]	N _{perm} ⁸⁾ [kN]	V _{perm} ⁸⁾ [kN]	[mm]	[mm]	[mm]	[mm]	[mm]	
FIS A M 20	5.8	140	90	120	20,5	34,9	170	435	270	85	85	
		220	170		53,3		385	300	510			
		450	400		58,6		85	195	1200			
	8.8	140	90		20,5	41,1	170	525	270			
		220	170		53,3	385	300	510				
		450	400		93,3	230	290	1200				
	A4-70	140	90		20,5	39,4	170	500	270			
		220	170		53,3		385	350	510			
		450	400		65,7		85	215	1200			
	C-70	140	90		20,5	41,1	170	525	270			
		220	170		53,3	385	455	510				
		450	400		81,9	135	260	1200				
FIS A M 24	5.8	160	96	150	22,6	45,2	170	540	290	105	105	
		270	210		73,2		475	390	630			
		540	480		84,3		105	250	1440			
	8.8	160	96		22,6	45,2	170	540	290			
		270	210		73,2	80,6	475	675	630			
		540	480		134,3	360	365	1440				
	A4-70	160	96		22,6	45,2	170	540	290			
		270	210		73,2	56,8	475	445	630			
		540	480		94,3	105	270	1440				
	C-70	160	96		22,6	45,2	170	540	290			
		270	210		73,2	70,9	475	580	630			
		540	480		117,6	235	325	1440				
FIS A M 27	5.8	170	108	200	27,0	54,0	195	605	325	120	120	
		310	250		95,1		65,7	565	460			750
		600	540		109,5		120	295	1620			
	8.8	170	108		27,0	54,0	195	605	325			
		310	250		95,1	105,1	565	805	750			
		600	540		175,2	505	450	1620				
	A4-70	170	108		27,0	54,0	195	605	325			
		310	250		95,1	73,7	565	530	750			
		600	540		123,0	140	320	1620				
	C-70	170	108		27,0	54,0	195	605	325			
		310	250		95,1	92,0	565	690	750			
		600	540		153,3	355	385	1620				
FIS A M 30	5.8	190	120	300	31,6	63,2	210	660	360	140	140	
		350	280		112,7		80,6	635	525			840
		670	600		133,8		140	330	1800			
	8.8	190	120		31,6	63,2	210	660	360			
		350	280		112,7	128,6	635	920	840			
		670	600		213,8	610	515	1800				
	A4-70	190	120		31,6	63,2	210	660	360			
		350	280		112,7	90,2	635	605	840			
		670	600		150,1	195	365	1800				
	C-70	190	120		31,6	63,2	210	660	360			
		350	280		112,7	112,6	635	785	840			
		670	600		187,1	445	435	1800				

Chemical fixings 3

LOADS

Superbond-System: Injection mortar FIS SB with Threaded rod FIS A ^{1) 2)}

zinc plated steel 5.8 / zinc plated steel 8.8 / stainless steel A4-70 / high corrosion resistant steel C-70

Permissible loads of a single anchor in non-cracked normal concrete (concrete compression zone) of strength class C20/25 (~B25) ^{3) 4) 5) 6)}										Minimum spacings while reducing the load	
Type	Material fixing element	Min. member thickness	Effective anchorage depth	Maximum torque moment	Permissible tensile load	Permissible shear load	Required edge distance (with one edge) for		Required spacing for	Min. spacing	Min. edge distance
							Max. tension load c	Max. shear load c			
		h_{min} [mm]	$h_{ef}^{7)}$ [mm]	T_{max} [Nm]	$N_{perm}^8)$ [kN]	$V_{perm}^8)$ [kN]	[mm]	[mm]	[mm]	[mm]	[mm]

For the design the complete assessment ETA-12/0258 has to be considered. ¹⁰⁾

1) Also valid for threaded rod RG M in the same property class.

2) Valid for injection mortar FIS SB. For using the glass capsule RSB see separate table resp. ETA-12/0258.

3) The partial safety factors for material resistance as regulated in the ETA-12/0258 as well as a partial safety factor for load actions of $\gamma_L = 1,4$ are considered. As an single anchor counts e.g. an anchor with a spacing $s \geq 3 \cdot h_{ef}$ and an edge distance $c \geq 1,5 \cdot h_{ef}$. Accurate data see ETA-12/0258.

4) The given loads are valid for injection mortar FIS SB for fixations in dry and humid concrete for temperatures in the substrate up to 50 °C (resp. short term up to 80 °C. For drill hole cleaning see ETA-12/0258.

5) For higher concrete strength classes up to C50/60 higher permissible loads may be possible.

6) Drill method hammer drilling.

7) For the sizes M8 - M30 the min. anchorage depth and the max. anchorage depth are given. The anchorage depth can be chosen freely between these borders.

8) For combinations of tensile loads and shear loads or for shear loads with lever arm (bending moments) as well as reduced edge distances or spacings (anchor groups) we recommend to use our anchor design software C-FIX.

9) Minimum possible axial spacings resp. edge distance while reducing the permissible load.

10) The given loads refer to the European Technical Assessment ETA-12/0258, issue date 19.05.2016. Design of the loads according ETAG 001, Technical Report TR 029 (for static resp. quasi-static loads).

LOADS

Superbond-System: Injection mortar FIS SB with Internal threaded anchor RG M I ¹⁾

zinc plated steel / stainless steel A4

Permissible loads of a single anchor in cracked normal concrete (concrete tension zone) of strength class C20/25 (~ B25) ^{2) 3) 4) 5) 9)}										Minimum spacings while reducing the load	
Type	Screw steel property/surface	Min. member thickness	Effective anchorage depth	Maximum torque moment	Permissible tensile load	Permissible shear load	Required edge distance (with one edge) for		Required spacing for	Min. spacing	Min. edge distance
							Max. tension load c	Max. shear load c			
		h_{min} [mm]	h_{ef} [mm]	T_{max} [Nm]	$N_{perm}^6)$ [kN]	$V_{perm}^6)$ [kN]	[mm]	[mm]	[mm]	[mm]	[mm]
RG M8 I	5.8	120	90	10	8,1	5,3	135	85	270	55	55
	8.8							145			
	A4-70							95			
RG M10 I	5.8	130	90	20	10,8	8,3	135	135	270	65	65
	8.8							235			
	A4-70							155			
RG M12 I	5.8	170	125	40	16,8	12,1	190	165	375	75	75
	8.8							285			
	A4-70							185			
RG M16 I	5.8	210	160	80	26,3	22,4	240	275	480	95	95
	8.8							405			
	A4-70							315			
RG M20 I	5.8	270	200	120	41,9	39,4	300	435	600	125	125
	8.8							595			
	A4-70							430			

For the design the complete assessment ETA-12/0258 has to be considered. ⁸⁾

1) Valid for injection mortar FIS SB. F or using the glass capsule RSB see separate table resp. ETA-12/0258.

2) The partial safety factors for material resistance as regulated in the ETA-12/0258 as well as a partial safety factor for load actions of $\gamma_L = 1,4$ are considered. As an single anchor counts e.g. an anchor with a spacing $s \geq 3 \cdot h_{ef}$ and an edge distance $c \geq 1,5 \cdot h_{ef}$. Accurate data see ETA-12/0258.

3) The given loads are valid for injection mortar FIS SB for fixations in dry and humid concrete for temperatures in the substrate up to 50 °C (resp. short term up to 80 °C. For drill hole cleaning see ETA-12/0258.

4) For higher concrete strength classes up to C50/60 higher permissible loads may be possible.

5) Drill method hammer drilling.

6) For combinations of tensile loads and shear loads or for shear loads with lever arm (bending moments) as well as reduced edge distances or spacings (anchor groups) we recommend to use our anchor design software C-FIX.

7) Minimum possible axial spacings resp. edge distance while reducing the permissible load.

8) The given loads refer to the European Technical Assessment ETA-12/0258, issue date 19.05.2016. Design of the loads according ETAG 001, Technical Report TR 029 (for static resp. quasi-static loads).

9) A reinforcement in the concrete to prevent splitting is required. The width of the cracks has to be limited under consideration of the splitting forces at $w_k \sim 0,3$.

LOADS

Superbond-System: Injection mortar FIS SB with Internal threaded anchor RG M I ¹⁾

zinc plated steel / stainless steel A4

Permissible loads of a single anchor in non-cracked normal concrete (concrete compression zone) of strength class C20/25 (~ B25) ^{2) 3) 4) 5)}										Minimum spacings while reducing the load	
Type	Screw steel property/surface	Min. member thickness	Effective anchorage depth	Maximum torque moment	Permissible tensile load	Permissible shear load	Required edge distance (with one edge) for		Required spacing for	Min. spacing	Min. edge distance
							Max. tension load c	Max. shear load c			
		h_{min} [mm]	h_{ef} [mm]	T_{max} [Nm]	$N_{perm}^{6)}$ [kN]	$V_{perm}^{6)}$ [kN]	[mm]	[mm]	Max. Load s_{cr} [mm]	$s_{min}^{7)}$ [mm]	$c_{min}^{7)}$ [mm]
RG M8 I	5.8	120	90	10	9,0	5,3	55	65	270	55	55
	8.8				13,8	8,3	110	95			
	A4-70				9,9	5,9	55	70			
RG M10 I	5.8	130	90	20	13,8	8,3	105	90	270	65	65
	8.8				20,5	13,3	190	155			
	A4-70				15,7	9,3	130	100			
RG M12 I	5.8	170	125	40	20,5	12,1	130	110	375	75	75
	8.8				32,4	19,3	265	190			
	A4-70				22,5	13,5	155	125			
RG M16 I	5.8	210	160	80	37,6	22,4	255	180	480	95	95
	8.8				48,7	30,9	365	265			
	A4-70				42,0	25,1	300	205			
RG M20 I	5.8	270	200	120	58,6	39,4	365	285	600	125	125
	8.8				68,0	51,4	445	395			
	A4-70				65,7	39,4	430	285			

For the design the complete assessment ETA-12/0258 has to be considered. ⁸⁾

¹⁾ Valid for injection mortar FIS SB. F or using the glass capsule RSB see separate table resp. ETA-12/0258.

²⁾ The partial safety factors for material resistance as regulated in the ETA-12/0258 as well as a partial safety factor for load actions of $\gamma_L = 1,4$ are considered. As a single anchor counts e.g. an anchor with a spacing $s \geq 3 \cdot h_{ef}$ and an edge distance $c \geq 1,5 \cdot h_{ef}$. Accurate data see ETA-12/0258.

³⁾ The given loads are valid for injection mortar FIS SB for fixations in dry and humid concrete for temperatures in the substrate up to 50 °C (resp. short term up to 80 °C. For drill hole cleaning see ETA-12/0258.

⁴⁾ For higher concrete strength classes up to C50/60 higher permissible loads may be possible.

⁵⁾ Drill method hammer drilling.

⁶⁾ For combinations of tensile loads and shear loads or for shear loads with lever arm (bending moments) as well as reduced edge distances or spacings (anchor groups) we recommend to use our anchor design software C-FIX.

⁷⁾ Minimum possible axial spacings resp. edge distance while reducing the permissible load.

⁸⁾ The given loads refer to the European Technical Assessment ETA-12/0258, issue date 19.05.2016. Design of the loads according ETAG 001, Technical Report TR 029 (for static resp. quasi-static loads).

INSTALLATION IN CONCRETE WITH CAPSULE RSB AND RG M

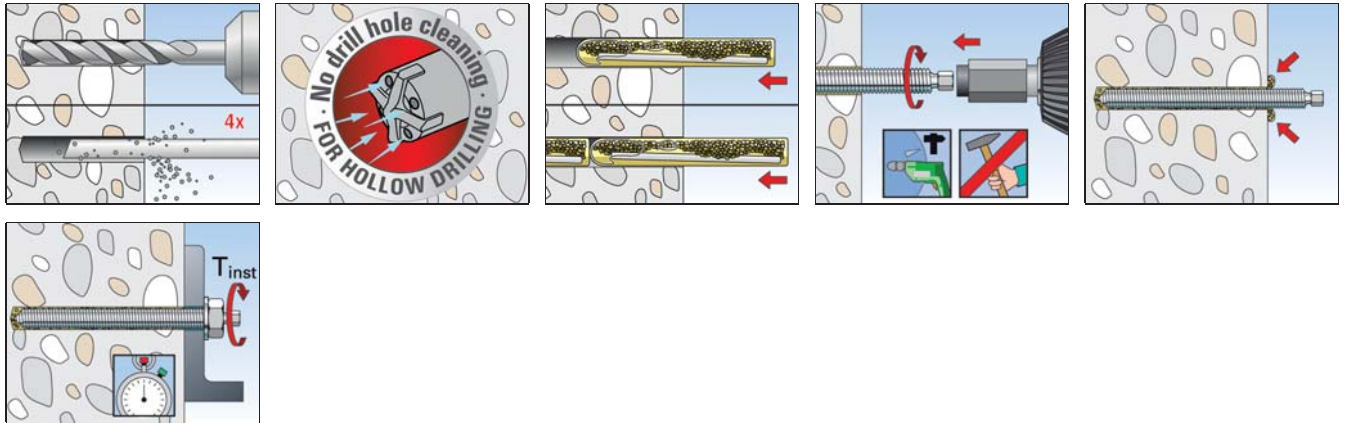

INSTALLATION IN CONCRETE WITH CAPSULE RSB AND RG M I

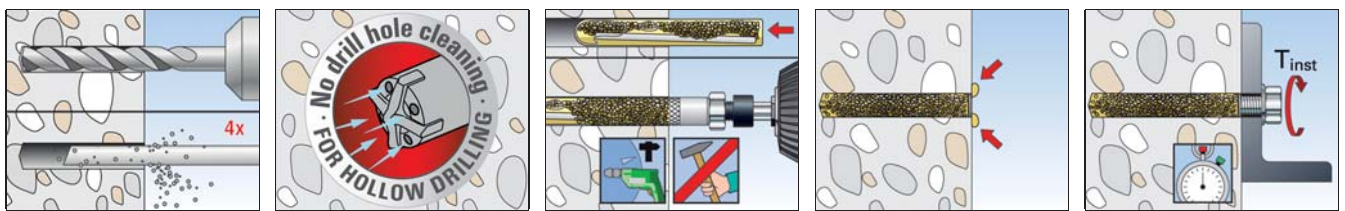

TECHNICAL DATA

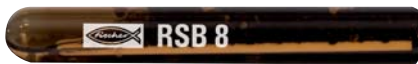

Resin capsule **RSB**

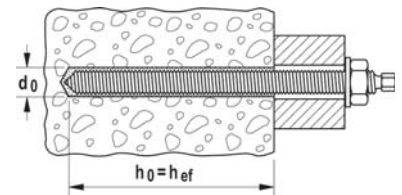

Item	Art.-No.	Approval		Drill hole diameter	Drill hole depth	Anchorage depth	Match	Sales unit
		ETA	ICC	d_0 [mm]	h_0 [mm]	h_{ef} [mm]		[pcs]
RSB 8	518807	■	▲	10	80	80	RG M 8	10
RSB 10 mini	518820 ¹⁾	■	▲	12	75 / 150	75 / 150	RG M 10	10
RSB 10	518821 ²⁾	■	▲	12 / 14	90	90	RG M 10 / RG M 8 I	10
RSB 12 mini	518822 ¹⁾	■	▲	14	75 / 150	75 / 150	RG M 12	10
RSB 12	518823 ²⁾	■	▲	14 / 18	110	110	RG M 12 / RG M 10 I	10
RSB 16 mini	518824 ¹⁾	■	▲	18	95 / 190	95 / 190	RG M 16	10
RSB 16	518825 ²⁾	■	▲	18 / 20	125	125	RG M 16 / RG M 12 I	10
RSB 16 E	518826	■	—	24	160	160	RG M 16 I	10
RSB 20	518827	■	▲	25	170	170	RG M 20	10
RSB 20 E/24	518828	■	▲	25 / 28 / 32	210	210	RG M 20 / RG M 24 / RG M 20 I	5
RSB 30	518829	■	▲	35	280	280	RG M 30	5

1) use 2 x RSB mini in a row for larger anchoring depth

2) / second value "Drill hole diameter" in conjunction with Internal threaded anchor RG M I

CURING TIME

Temperature in anchoring base	Curing time RSB
-30°C - -20°C	120 hrs.
-19°C - -15°C	48 hrs.
-14°C - -10°C	30 hrs.
-9°C - -5°C	16 hrs.
-4°C - ± 0°C	10 hrs.
+1°C - +5°C	45 min.
+6°C - +10°C	30 min.
+11°C - +20°C	20 min.
+21°C - +30°C	5 min.
+31°C - +40°C	3 min.

LOADS

Superbond-System: Resin capsule RSB with Threaded rod RG M ¹⁾

zinc plated steel 5.8 / zinc plated steel 8.8 / stainless steel A4-70 / high corrosion resistant steel C-70

Permissible loads of a single anchor in cracked normal concrete (concrete tension zone) of strength class C20/25 (~ B25) ²⁾³⁾⁴⁾⁹⁾										Minimum spacings while reducing the load	
Type	Material fixing element	Min. member thickness	Effective anchorage depth	Maximum torque moment	Permissible tensile load	Permissible shear load	Required edge distance (with one edge) for		Required spacing for	Min. spacing	Min. edge distance
							Max. tension load c	Max. shear load c			
		h _{min} [mm]	h _{ef} [mm]	T _{max} [Nm]	N _{perm} ⁶⁾ [kN]	V _{perm} ⁶⁾ [kN]	[mm]	[mm]	[mm]	[mm]	[mm]
RG M 8 ⁵⁾	5.8	110	80	10	5,7	5,1	105	95	240	40	40
	8.8					8,6		170			
	A4-70					6,0		115			
	C-70					7,4		145			
RG M 10 ⁵⁾	5.8	110	75	20	7,3	8,6	115	170	225	45	45
	8.8					13,1		280			
	A4-70					9,2		185			
	C-70					11,4		240			
	5.8	120	90	20	8,8	8,6	130	155	270		
	8.8					13,1		250			
	A4-70					9,2		165			
	C-70					11,4		215			
	5.8	180	150	20	13,8	8,6	120	115	450		
	8.8					13,1		185			
	A4-70					9,2		120			
						14,6		130			
RG M 12 ⁵⁾	5.8	110	75	40	10,1	12,0	115	245	225	55	55
	8.8					19,4		420			
	A4-70					13,7		285			
	C-70					17,1		365			
	5.8	140	110	40	14,8	12,0	155	195	330		
	8.8					19,4		340			
	A4-70					13,7		230			
	C-70					17,1		295			
	5.8	180	150	40	20,2	12,0	120	160	450		
	8.8					19,4		280			
	A4-70					13,7		185			
						14,6		130			
RG M 16	5.8	140	95	60	15,9	22,3	145	410	285	65	65
	8.8					31,7		605			
	A4-70					25,2		470			
	C-70					31,4		600			
	5.8	170	125	60	22,4	22,3	190	350	375		
	8.8					36,0		600			
	A4-70					25,2		400			
	C-70					31,4		515			
	5.8	230	190	60	34,1	22,3	210	265	570		
	8.8					36,0		465			
	A4-70					25,2		305			
						34,1		210			

LOADS

Superbond-System: Resin capsule RSB with Threaded rod RG M ¹⁾

zinc plated steel 5.8 / zinc plated steel 8.8 / stainless steel A4-70 / high corrosion resistant steel C-70

Permissible loads of a single anchor in cracked normal concrete (concrete tension zone) of strength class C20/25 (~ B25) ^{2) 3) 4) 9)}										Minimum spacings while reducing the load	
Type	Material fixing element	Min. member thickness	Effective anchorage depth	Maximum torque moment	Permissible tensile load	Permissible shear load	Required edge distance (with one edge) for		Required spacing for	Min. spacing	Min. edge distance
							Max. tension load c	Max. shear load c			
		h _{min} [mm]	h _{ef} [mm]	T _{max} [Nm]	N _{perm} ⁶⁾ [kN]	V _{perm} ⁶⁾ [kN]	[mm]	[mm]	[mm]	[mm]	[mm]
RG M 20	5.8	220	170	120	38,0	34,9	255	450	510	85	85
	8.8					56,0		780			
	A4-70					39,4		520			
	5.8	260	210		47,1	280	34,9	395	630		
	8.8				56,0		685				
	A4-70				39,4		455				
RG M 24	5.8	270	210	150	52,2	50,9	315	590	630	105	105
	8.8					80,6		1005			
	A4-70					56,8		670			
RG M 30	5.8	350	280	300	80,3	80,6	420	795	840	140	140
	A4-70					90,2		910			

For the design the complete assessment ETA-12/0258 has to be considered. ⁸⁾

¹⁾ Valid for glass capsule RSB. For using the injection mortar FIS SB see separate table resp. ETA-12/0258.

²⁾ The partial safety factors for material resistance as regulated in the ETA-12/0258 as well as a partial safety factor for load actions of $\gamma_L = 1,4$ are considered. As an single anchor counts e.g. an anchor with a spacing $s \geq 3 \cdot h_{ef}$ and an edge distance $c \geq 1,5 \cdot h_{ef}$. Accurate data see ETA-12/0258.

³⁾ For higher concrete strength classes up to C50/60 higher permissible loads may be possible.

⁴⁾ Drill method hammer drilling. For further allowable drill methods and application conditions see ETA-12/0258.

⁵⁾ Diamond drilling not permitted.

⁶⁾ For combinations of tensile loads and shear loads or for shear loads with lever arm (bending moments) as well as reduced edge distances or spacings (anchor groups) we recommend to use our anchor design software C-FIX.

⁷⁾ Minimum possible axial spacings resp. edge distance while reducing the permissible load.

⁸⁾ The given loads refer to the European Technical Assessment ETA-12/0258, issue date 19.05.2016. Design of the loads according ETAG 001, Technical Report TR 029 (for static resp. quasi-static loads).

⁹⁾ A reinforcement in the concrete to prevent splitting is required. The width of the cracks has to be limited under consideration of the splitting forces at $w_k \sim 0,3$ mm.

LOADS

Superbond-System: Resin capsule RSB with Threaded rod RG M ¹⁾

zinc plated steel 5.8 / zinc plated steel 8.8 / stainless steel A4-70 / high corrosion resistant steel C-70

Permissible loads of a single anchor in non-cracked normal concrete (concrete compression zone) of strength class C20/25 (~ B25) ^{2) 3) 4) 9)}										Minimum spacings while reducing the load	
Type	Material fixing element	Min. member thickness	Effective anchorage depth	Maximum torque moment	Permissible tensile load	Permissible shear load	Required edge distance (with one edge) for		Required spacing for	Min. spacing	Min. edge distance
							Max. tension load c	Max. shear load c			
		h _{min} [mm]	h _{ef} [mm]	T _{max} [Nm]	N _{perm} ⁵⁾ [kN]	V _{perm} ⁵⁾ [kN]	[mm]	[mm]	[mm]	[mm]	[mm]
RG M 8	5.8	110	80	10	9,0	5,1	75	70	240	40	40
	8.8				11,5	8,6	105	115			
	A4-70				9,9	6,0	85	75			
	C-70				11,5	7,4	105	100			
RG M 10	5.8	110	75	20	13,5	8,6	130	115	225	45	45
	8.8					13,1		190			
	A4-70					9,2		125			
	C-70					11,4		160			
	5.8	120	90		13,8	8,6	110	105	270		
	8.8				16,2	13,1	145	170			
	A4-70				15,7	9,2	140	110			
	C-70				16,2	11,4	145	145			
5.8	180	150	13,8	8,6	45	90	450				
8.8			22,4	13,1	100	120					
A4-70			15,7	9,2	55	95					

LOADS

Superbond-System: Resin capsule RSB with Threaded rod RG M ¹⁾

zinc plated steel 5.8 / zinc plated steel 8.8 / stainless steel A4-70 / high corrosion resistant steel C-70

Permissible loads of a single anchor in non-cracked normal concrete (concrete compression zone) of strength class C20/25 (~ B25) ^{2) 3) 4) 9)}										Minimum spacings while reducing the load		
Type	Material fixing element	Min. member thickness h_{min} [mm]	Effective anchorage depth h_{ef} [mm]	Maximum torque moment T_{max} [Nm]	Permissible tensile load $N_{perm}^{5)}$ [kN]	Permissible shear load $V_{perm}^{5)}$ [kN]	Required edge distance (with one edge) for		Required spacing for Max. Load s_{cr} [mm]	Min. spacing $s_{min}^{6)}$ [mm]	Min. edge distance $c_{min}^{6)}$ [mm]	
							Max. tension load c [mm]	Max. shear load c [mm]				
RG M 12	5.8	110	75	40	15,6		160	12,0	165	225	55	55
	8.8							19,4	285			
	A4-70							13,7	195			
	C-70							17,1	250			
	5.8	140	110		20,5	12,0	165	130	330			
	8.8				23,7	19,4	205	230				
	A4-70				22,5	13,7	190	155				
	C-70				23,7	17,1	205	200				
	5.8	180	150		20,5	12,0	75	110	450			
	8.8				32,3	19,4	220	190				
	A4-70				22,5	13,7	100	125				
RG M 16	5.8	140	95	60	22,3		205	22,3	275	285	65	65
	8.8							36,0	475			
	A4-70							25,2	315			
	C-70							31,4	405			
	5.8	170	125		22,3	235	285	235	375			
	8.8				36,0	405		405				
	A4-70				25,2	270		270				
	C-70				31,4	350		350				
	5.8	230	190		37,6	22,3	190	175	570			
	8.8				59,1	36,0	400	310				
	A4-70				42,0	25,2	235	200				
RG M 20	5.8	220	170	120	53,3		385	34,9	300	510	85	85
	8.8							56,0	525			
	A4-70							39,4	345			
	5.8	260	210		58,6	34,9	350	260	630			
	8.8				73,2	56,0	475	460				
	A4-70				65,7	39,4	415	300				
RG M 24	5.8	270	210	150	73,2		475	50,9	390	630	105	105
	8.8							80,6	675			
	A4-70							56,8	445			
RG M 30	5.8	350	280	300	112,7		635	80,6	525	840	140	140
	A4-70							90,2	605			

For the design the complete assessment ETA-12/0258 has to be considered. ⁷⁾

¹⁾ Valid for glass capsule RSB. For using the injection mortar FIS SB see separate table resp. ETA-12/0258.

²⁾ The partial safety factors for material resistance as regulated in the ETA-12/0258 as well as a partial safety factor for load actions of $\gamma_L = 1,4$ are considered. As an single anchor counts e.g. an anchor with a spacing $s \geq 3 \cdot h_{ef}$ and an edge distance $c \geq 1,5 \cdot h_{ef}$. Accurate data see ETA-12/0258.

³⁾ For higher concrete strength classes up to C50/60 higher permissible loads may be possible.

⁴⁾ Drill method hammer drilling. For further allowable drill methods and application conditions see ETA-12/0258.

⁵⁾ For combinations of tensile loads and shear loads or for shear loads with lever arm (bending moments) as well as reduced edge distances or spacings (anchor groups) we recommend to use our anchor design software C-FIX.

⁶⁾ Minimum possible axial spacings resp. edge distance while reducing the permissible load.

⁷⁾ The given loads refer to the European Technical Assessment ETA-12/0258, issue date 19.05.2016. Design of the loads according ETAG 001, Technical Report TR 029 (for static resp. quasi-static loads).

LOADS

Superbond-System: Resin capsule RSB with Internal threaded anchor RG M I ¹⁾

zinc plated steel / stainless steel A4

Permissible loads of a single anchor in cracked normal concrete (concrete tension zone) of strength class C20/25 (~ B25) ^{2) 3) 4) 9)}										Minimum spacings while reducing the load	
Type	Screw steel property/surface	Min. member thickness h_{min} [mm]	Effective anchorage depth h_{ef} [mm]	Maximum torque moment T_{max} [Nm]	Permissible tensile load $N_{perm}^{6)}$ [kN]	Permissible shear load $V_{perm}^{6)}$ [kN]	Required edge distance (with one edge) for		Required spacing for Max. Load s_{cr} [mm]	Min. spacing $s_{min}^{7)}$ [mm]	Min. edge distance $c_{min}^{7)}$ [mm]
							Max. tension load c [mm]	Max. shear load c [mm]			
RG M8 I ⁵⁾	5.8	120	90	10	8,1	5,3	135	85	270	55	55
	8.8							145			
	A4-70							95			
RG M10 I	5.8	130	90	20	10,8	8,3	135	135	270	65	65
	8.8							235			
	A4-70							155			
RG M12 I	5.8	170	125	40	16,8	12,1	190	165	375	75	75
	8.8							285			
	A4-70							185			
RG M16 I	5.8	210	160	80	26,3	22,4	240	275	480	95	95
	8.8							405			
	A4-70							315			
RG M20 I	5.8	270	200	120	41,9	39,4	300	435	600	125	125
	8.8							595			
	A4-70							39,4			

For the design the complete assessment ETA-12/0258 has to be considered. ⁷⁾

¹⁾ Valid for glass capsule RSB. For using the injection mortar FIS SB see separate table resp. ETA-12/0258.

²⁾ The partial safety factors for material resistance as regulated in the ETA-12/0258 as well as a partial safety factor for load actions of $\gamma_L = 1,4$ are considered. As an single anchor counts e.g. an anchor with a spacing $s \geq 3 \cdot h_{ef}$ and an edge distance $c \geq 1,5 \cdot h_{ef}$. Accurate data see ETA-12/0258.

³⁾ For higher concrete strength classes up to C50/60 higher permissible loads may be possible.

⁴⁾ Drill method hammer drilling. For further allowable drill methods and application conditions see ETA-12/0258.

⁵⁾ Diamond drilling not permitted.

⁶⁾ For combinations of tensile loads and shear loads or for shear loads with lever arm (bending moments) as well as reduced edge distances or spacings (anchor groups) we recommend to use our anchor design software C-FIX.

⁷⁾ Minimum possible axial spacings resp. edge distance while reducing the permissible load.

⁷⁾ The given loads refer to the European Technical Assessment ETA-12/0258, issue date 19.05.2016. Design of the loads according ETAG 001, Technical Report TR 029 (for static resp. quasi-static loads).

⁹⁾ A reinforcement in the concrete to prevent splitting is required. The width of the cracks has to be limited under consideration of the splitting forces at $w_k \sim 0,3$ mm.

LOADS

Superbond-System: Resin capsule RSB with Internal threaded anchor RG M I ¹⁾

zinc plated steel / stainless steel A4

Permissible loads of a single anchor in non-cracked normal concrete (concrete compression zone) of strength class C20/25 (~ B25) ^{2) 3) 4)}										Minimum spacings while reducing the load	
Type	Screw steel property/surface	Min. member thickness	Effective anchorage depth	Maximum torque moment	Permissible tensile load	Permissible shear load	Required edge distance (with one edge) for		Required spacing for	Min. spacing	Min. edge distance
							Max. tension load c	Max. shear load c			
		h_{min} [mm]	h_{ef} [mm]	T_{max} [Nm]	$N_{perm}^{5)}$ [kN]	$V_{perm}^{5)}$ [kN]	[mm]	[mm]	Max. Load s_{cr} [mm]	$s_{min}^{6)}$ [mm]	$c_{min}^{6)}$ [mm]
RG M8 I	5.8	120	90	10	9,0	5,3	55	65	270	55	55
	8.8				13,8	8,3	110	95			
	A4-70				9,9	5,9	55	70			
RG M10 I	5.8	130	90	20	13,8	8,3	105	90	270	65	65
	8.8				20,5	13,3	190	155			
	A4-70				15,7	9,3	130	100			
RG M12 I	5.8	170	125	40	20,5	12,1	130	110	375	75	75
	8.8				32,4	19,3	265	190			
	A4-70				22,5	13,5	155	125			
RG M16 I	5.8	210	160	80	37,6	22,4	255	180	480	95	95
	8.8				48,7	30,9	365	265			
	A4-70				42,0	25,1	300	205			
RG M20 I	5.8	270	200	120	58,6	39,4	365	285	600	125	125
	8.8				68,0	51,4	445	395			
	A4-70				65,7	39,4	430	285			

For the design the complete assessment ETA-12/0258 has to be considered. ⁷⁾

¹⁾ Valid for glass capsule RSB. For using the injection mortar FIS SB see separate table resp. ETA-12/0258.

²⁾ The partial safety factors for material resistance as regulated in the ETA-12/0258 as well as a partial safety factor for load actions of $\gamma_L = 1,4$ are considered. As an single anchor counts e.g. an anchor with a spacing $s \geq 3 \cdot h_{ef}$ and an edge distance $c \geq 1,5 \cdot h_{ef}$. Accurate data see ETA-12/0258.

³⁾ For higher concrete strength classes up to C50/60 higher permissible loads may be possible.

⁴⁾ Drill method hammer drilling. For further allowable drill methods and application conditions see ETA-12/0258.

⁵⁾ For combinations of tensile loads and shear loads or for shear loads with lever arm (bending moments) as well as reduced edge distances or spacings (anchor groups) we recommend to use our anchor design software C-FIX.

⁶⁾ Minimum possible axial spacings resp. edge distance while reducing the permissible load.

⁷⁾ The given loads refer to the European Technical Assessment ETA-12/0258, issue date 19.05.2016. Design of the loads according ETAG 001, Technical Report TR 029 (for static resp. quasi-static loads).

The bonded anchor for cracked concrete with threaded rod RG M without drill hole cleaning



Crash barriers



Collision protection

VERSIONS

- Zinc-plated steel
- Stainless steel
- Highly corrosion-resistant steel
- Hot-dip galvanised steel

BUILDING MATERIALS

Approved for:

- Concrete C20/25 to C50/60, cracked and non-cracked

Also suitable for:

- Natural stone with dense structure

CERTIFICATES



ADVANTAGES

- RM II is the first bonded anchor with threaded rod RG M for cracked and non-cracked concrete that does not require drill hole cleaning. This allows for a rapid working progress and an economic installation.
- Moreover, there is a reduced exposition to drill dust on the building site. This increases the safety for the user.
- The pre-portioned resin capsule is easy to install and especially suitable for individual applications and overhead installations.

APPLICATIONS

- Steel constructions
 - Guard rails
 - Staircases
 - Column bases
 - Machines
 - Masts
- Ideal for:**
- Overhead installations
 - Water-filled drill holes

FUNCTIONING

- The resin anchor RM II is suitable for pre-positioned installation when combined with the threaded rod RG M.
- The 2-component resin capsule RM II contains styrene-free vinyl ester resin and hardener.
- The threaded rod RG M is set using a hammer drill and the accompanying setting tool in rotating and hitting motions.
- During setting, the oblique edge of the RG M destroys the capsule, and mixes and activates the mortar.
- The mortar bonds the entire surface of the threaded rod with the drill hole wall and seals the drill hole.

SEE ALSO



ANCHORS + SLEEVES

Page 144



DISPENSER

Page 195



ACCESSORIES

Page 198

INSTALLATION IN CONCRETE WITH CAPSULE RM II AND RG M

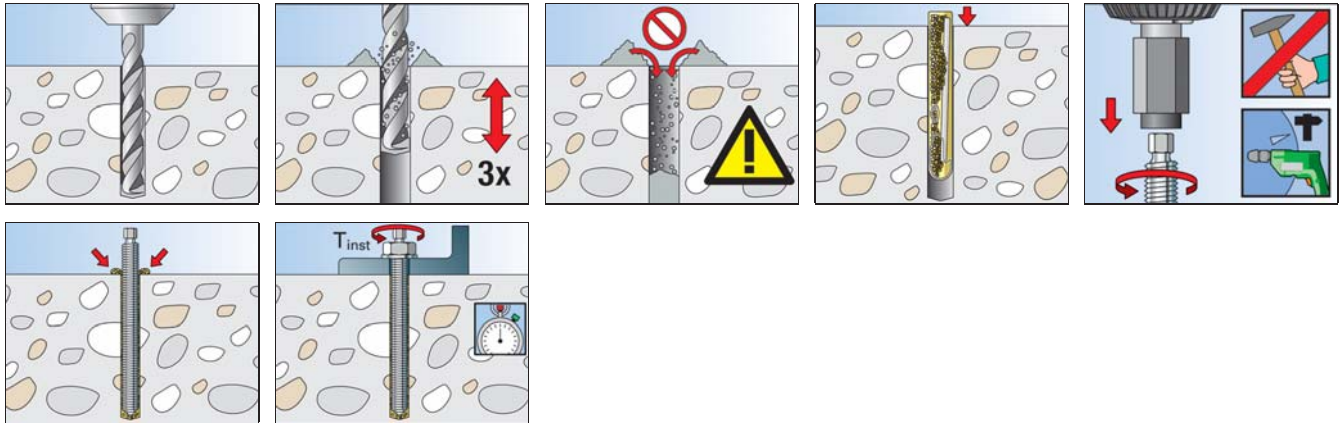

TECHNICAL DATA



Resin capsule **RM II**

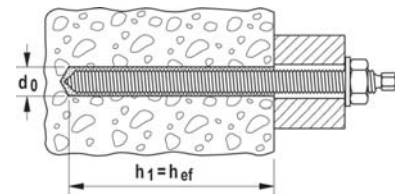

Item	Art.-No.	Approval ETA	Drill hole diameter d_0 [mm]	Min. drill hole depth h_1 [mm]	Effect. anchorage depth h_{ef} [mm]	Suitable for threaded rod	Sales unit [pcs]
RM II 8	539796	■	10	80	80	RG M 8	10
RM II 10	539797	■	12	90	90	RG M10	10
RM II 12	539798	■	14	110	110	RG M 12	10
RM II 14	539799	—	16	120	120	RG M 14	10
RM II 16	539800	■	18	125	125	RG M 16	10
RM II 20/22	539802 1)	■	25	170 / 190	170 / 190	RG M 20 / RG M 22	10
RM II 24	539803	■	28	210	210	RG M 24	5

1) RM II 20/22 in combination with RG M 22 and effect. anchorage depth of 190 mm is not part of the assessment.

CURING TIME

Temperature at anchoring base	Curing time
-15 °C - -11 °C	30 hrs.
- 10 °C - - 6 °C	16 hrs.
- 5 °C - - 1 °C	10 hrs.
+ 0 °C - + 4 °C	45 min.
+ 5 °C - + 9 °C	30 min.
+10 °C - +19 °C	20 min.
+20 °C - +29 °C	5 min.
+30 °C - +40 °C	3 min.

LOADS

Resin anchor RM II: Resin capsule RM II with Threaded rod RG M

zinc plated steel 5.8 / zinc plated steel 8.8 / stainless steel A4-70 / high corrosion resistant steel C-70

Permissible loads of a single anchor in cracked normal concrete (concrete tension zone) of strength class C20/25 (~B25) ^{1) 2) 3) 4) 8)}										Minimum spacings while reducing the load	
Type	Material fixing element	Min. member thickness h_{min} [mm]	Effective anchorage depth h_{ef} [mm]	Maximum torque moment T_{max} [Nm]	Permissible tensile load $N_{perm}^{5)}$ [kN]	Permissible shear load $V_{perm}^{5)}$ [kN]	Required edge distance (with one edge) for		Required spacing for Max. Load s_{cr} [mm]	Min. spacing $s_{min}^{6)}$ [mm]	Min. edge distance $c_{min}^{6)}$ [mm]
							Max. tension load c [mm]	Max. shear load c [mm]			
RG M 10	5.8	120	90	20	3,9	8,6	120	155	270	45	45
	8.8							175			
	A4-70							165			
	C-70							175			
RG M 12	5.8	140	110	40	5,8	12,0	145	195	330	55	55
	8.8							230			
	A4-70							230			
	C-70							230			
RG M 16	5.8	170	125	60	8,7	20,9	190	325	375	65	65
	8.8							325			
	A4-70							325			
	C-70							325			
RG M 20	5.8	220	170	120	14,8	34,9	240	450	510	85	85
	8.8					35,6		460			
	A4-70					35,6		460			
RG M 24	5.8	270	210	150	22,0	50,9	285	590	630	105	105
	8.8					52,8		615			
	A4-70					52,8		615			

For the design the complete assessment ETA-16/0340 has to be considered. ⁷⁾

¹⁾ The partial safety factors for material resistance as regulated in the ETA-16/0340 as well as a partial safety factor for load actions of $\gamma_L = 1,4$ are considered. As an single anchor counts e.g. an anchor with a spacing $s \geq 3 \cdot h_{ef}$ and an edge distance $c \geq 1,5 \cdot h_{ef}$. Accurate data see ETA-16/0340.

²⁾ The given loads are valid for RM II for fixations in dry and humid concrete for temperatures in the substrate up to 72 °C (resp. short term up to 120 °C in accordance with ETA-16/0340).

³⁾ For higher concrete strength classes up to C50/60 higher permissible loads may be possible.

⁴⁾ Drill method hammer drilling. For further allowable application conditions see ETA-16/0340.

⁵⁾ For combinations of tensile loads and shear loads or for shear loads with lever arm (bending moments) as well as reduced edge distances or spacings (anchor groups) we recommend to use our anchor design software C-FIX.

⁶⁾ Minimum possible axial spacings resp. edge distance while reducing the permissible load.

⁷⁾ The given loads refer to the European Technical Assessment ETA-16/0340, issue date 06.10.2017. Design of the loads according ETAG 001, Technical Report TR 029 (for static resp. quasi-static loads).

⁸⁾ A reinforcement in the concrete to prevent splitting is required. The width of the cracks has to be limited under consideration of the splitting forces at $w_k \sim 0,3$ mm.

LOADS

Resin anchor RM II: Resin capsule RM II with Threaded rod RG M

zinc plated steel 5.8 / zinc plated steel 8.8 / stainless steel A4-70 / high corrosion resistant steel C-70

Permissible loads of a single anchor in non-cracked normal concrete (concrete compression zone) of strength class C20/25 (~B25) ^{1) 2) 3) 4)}										Minimum spacings while reducing the load	
Type	Material fixing element	Min. member thickness h_{min} [mm]	Effective anchorage depth h_{ef} [mm]	Maximum torque moment T_{max} [Nm]	Permissible tensile load $N_{perm}^{5)}$ [kN]	Permissible shear load $V_{perm}^{5)}$ [kN]	Required edge distance (with one edge) for		Required spacing for Max. Load s_{cr} [mm]	Min. spacing $s_{min}^{6)}$ [mm]	Min. edge distance $c_{min}^{6)}$ [mm]
							Max. tension load c [mm]	Max. shear load c [mm]			
RG M 8	5.8	110	80	10	8,4	5,1	95	70	240	40	40
	8.8							115			
	A4-70							75			
	C-70							100			
RG M 10	5.8	120	90	20	11,8	8,6	120	105	270	45	45
	8.8							170			
	A4-70							110			
	C-70							145			
RG M 12	5.8	140	110	40	17,3	12,0	165	130	330	55	55
	8.8							230			
	A4-70							155			
	C-70							200			
RG M 16	5.8	170	125	60	26,2	22,3	260	235	375	65	65
	8.8							405			
	A4-70							270			
	C-70							350			
RG M 20	5.8	220	170	120	44,4	34,9	385	300	510	85	85
	8.8							525			
	A4-70							345			
RG M 24	5.8	270	210	150	61,0	50,9	475	390	630	105	105
	8.8							675			
	A4-70							445			

For the design the complete assessment ETA-16/0340 has to be considered. ⁷⁾

- ¹⁾ The partial safety factors for material resistance as regulated in the ETA-16/0340 as well as a partial safety factor for load actions of $\gamma_L = 1,4$ are considered. As an single anchor counts e.g. an anchor with a spacing $s \geq 3 \cdot h_{ef}$ and an edge distance $c \geq 1,5 \cdot h_{ef}$. Accurate data see ETA-16/0340.
- ²⁾ The given loads are valid for RM II for fixations in dry and humid concrete for temperatures in the substrate up to 72 °C (resp. short term up to 120 °C in accordance with ETA-16/0340).
- ³⁾ For higher concrete strength classes up to C50/60 higher permissible loads may be possible.
- ⁴⁾ Drill method hammer drilling. For further allowable application conditions see ETA-16/0340.
- ⁵⁾ For combinations of tensile loads and shear loads or for shear loads with lever arm (bending moments) as well as reduced edge distances or spacings (anchor groups) we recommend to use our anchor design software C-FIX.
- ⁶⁾ The given loads refer to the European Technical Assessment ETA-16/0340, issue date 06.10.2017. Design of the loads according ETAG 001, Technical Report TR 029 (for static resp. quasi-static loads).

3
Chemical fixings

INSTALLATION IN CONCRETE WITH CAPSULE RM II AND RG M I

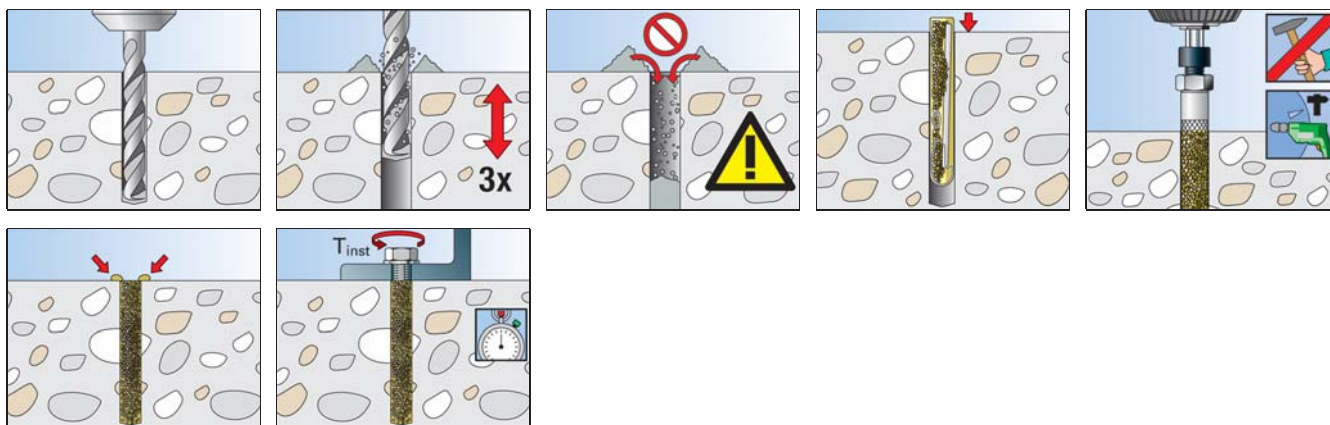

TECHNICAL DATA



Resin capsule RM II

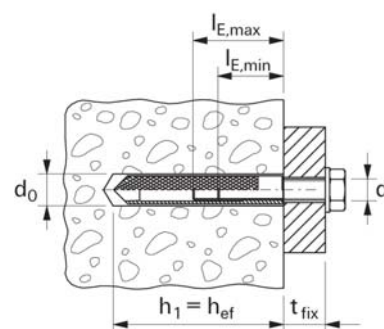

Item	Art.-No.	Approval ETA	Drill diameter d_0 [mm]	Min. drill hole depth h_1 [mm]	Effect. anchorage depth h_{ef} [mm]	Suitable for internal- threaded anchor	Sales unit [pcs]
RM II 10	539797	■	14	90	90	RG M8 I	10
RM II 12	539798	■	18	90	90	RG M10 I	10
RM II 16	539800	■	20	125	125	RG M12 I	10
RM II 16 E	539801	■	24	160	160	RG M16 I	10
RM II 24	539803	■	32	200	200	RG M20 I	5

CURING TIME

Temperature at anchoring base	Curing time
-15 °C - -11 °C	30 hrs.
- 10 °C - - 6 °C	16 hrs.
- 5 °C - - 1 °C	10 hrs.
+ 0 °C - + 4 °C	45 min.
+ 5 °C - + 9 °C	30 min.
+10 °C - +19 °C	20 min.
+20 °C - +29 °C	5 min.
+30 °C - +40 °C	3 min.

LOADS

Resin anchor RM II: Resin capsule RM II with Internal threaded anchor RG M I

zinc plated steel / stainless steel A4

Permissible loads of a single anchor in cracked normal concrete (concrete tension zone) of strength class C20/25 (~B25) ^{1) 2) 3) 4) 7)}										Minimum spacings while reducing the load	
Type	Screw steel property/surface	Min. member thickness	Effective anchorage depth	Maximum torque moment	Permissible tensile load	Permissible shear load	Required edge distance (with one edge) for		Required spacing for	Min. spacing	Min. edge distance
							Max. tension load c	Max. shear load c			
		h _{min} [mm]	h _{ef} [mm]	T _{max} [Nm]	N _{perm} ⁴⁾ [kN]	V _{perm} ⁴⁾ [kN]	[mm]	[mm]	[mm]	[mm]	[mm]
RG M 8 I	5.8	120	90	10	4,7		135	85	270	55	55
	8.8							145			
	A4-70							95			
RG M 10 I	5.8	130	90	20	6,3		135	135	270	65	65
	8.8							235			
	A4-70							155			
RG M 12 I	5.8	170	125	40	9,8		190	165	375	75	75
	8.8							285			
	A4-70							185			
RG M 16 I	5.8	210	160	80	15,4		240	275	480	95	95
	8.8							405			
	A4-70							315			
RG M 20 I	5.8	270	200	120	24,4		300	385	600	125	125
	8.8							600			
	A4-70							435			

For the design the complete assessment ETA-16/0340 has to be considered.⁶⁾

- ¹⁾ The partial safety factors for material resistance as regulated in the ETA-16/0340 as well as a partial safety factor for load actions of $\gamma_L = 1,4$ are considered. As an single anchor counts e.g. an anchor with a spacing $s \geq 3 \cdot h_{ef}$ and an edge distance $c \geq 1,5 \cdot h_{ef}$. Accurate data see ETA-16/0340.
- ²⁾ For higher concrete strength classes up to C50/60 higher permissible loads may be possible.
- ³⁾ Drill method hammer drilling. For further allowable application conditions see ETA-16/0340.
- ⁴⁾ For combinations of tensile loads and shear loads or for shear loads with lever arm (bending moments) as well as reduced edge distances or spacings (anchor groups) we recommend to use our anchor design software C-FIX.
- ⁵⁾ Minimum possible axial spacings resp. edge distance while reducing the permissible load.
- ⁶⁾ The given loads refer to the European Technical Assessment ETA-16/0340, issue date 06.10.2017. Design of the loads according ETAG 001, Technical Report TR 029 (for static resp. quasi-static loads).
- ⁷⁾ A reinforcement in the concrete to prevent splitting is required. The width of the cracks has to be limited under consideration of the splitting forces at $w_k \sim 0,3$ mm.

LOADS

Resin anchor RM II: Resin capsule RM II with Internal threaded anchor RG M I

zinc plated steel / stainless steel A4

Permissible loads of a single anchor in non-cracked normal concrete (concrete compression zone) of strength class C20/25 (~B25) ¹⁾²⁾³⁾										Minimum spacings while reducing the load	
Type	Screw steel property/surface	Min. member thickness h_{min} [mm]	Effective anchorage depth h_{ef} [mm]	Maximum torque moment T_{max} [Nm]	Permissible tensile load $N_{perm}^{4)}$ [kN]	Permissible shear load $V_{perm}^{4)}$ [kN]	Required edge distance (with one edge) for		Required spacing for Max. Load s_{cr} [mm]	Min. spacing $s_{min}^{5)}$ [mm]	Min. edge distance $c_{min}^{5)}$ [mm]
							Max. tension load c [mm]	Max. shear load c [mm]			
RG M 8 I	5.8	120	90	10	9,0	5,3	85	65	270	55	55
	8.8										
	A4-70										
RG M 10 I	5.8	130	90	20	13,8	8,3	140	90	270	65	65
	8.8										
	A4-70										
RG M 12 I	5.8	170	125	40	20,5	12,1	180	110	375	75	75
	8.8										
	A4-70										
RG M 16 I	5.8	210	160	80	37,6	22,4	330	180	480	95	95
	8.8										
	A4-70										
RG M 20 I	5.8	270	200	120	56,7	35,4	445	250	600	125	125
	8.8										
	A4-70										

For the design the complete assessment ETA-16/0340 has to be considered. ⁶⁾

¹⁾ The partial safety factors for material resistance as regulated in the ETA-16/0340 as well as a partial safety factor for load actions of $\gamma_L = 1,4$ are considered. As an single anchor counts e.g. an anchor with a spacing $s \geq 3 \cdot h_{ef}$ and an edge distance $c \geq 1,5 \cdot h_{ef}$. Accurate data see ETA-16/0340.

²⁾ For higher concrete strength classes up to C50/60 higher permissible loads may be possible.

³⁾ Drill method hammer drilling. For further allowable application conditions see ETA-16/0340.

⁴⁾ For combinations of tensile loads and shear loads or for shear loads with lever arm (bending moments) as well as reduced edge distances or spacings (anchor groups) we recommend to use our anchor design software C-FIX.

⁵⁾ Minimum possible axial spacings resp. edge distance while reducing the permissible load.

⁶⁾ The given loads refer to the European Technical Assessment ETA-16/0340, issue date 06.10.2017. Design of the loads according ETAG 001, Technical Report TR 029 (for static resp. quasi-static loads).

The powerful injection mortar for rebar connections and cracked concrete

3
Chemical fixings

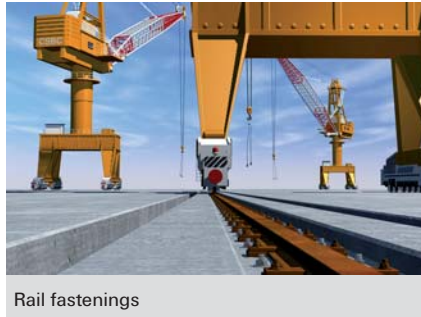

Rail fastenings



Rebar connections

BUILDING MATERIALS

Approved for anchorings in:

- Concrete C20/25 to C50/60, cracked and non-cracked

Also suitable for:

- Natural stone with dense structure

CERTIFICATES

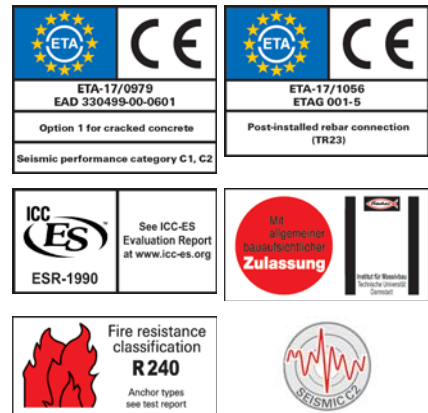

ADVANTAGES

- The optimised formulation of the epoxy resin mortar FIS EM Plus leads to improved load values in cracked and non-cracked concrete.
- The mortar can be used for rebar connections from diameter 8 to 40 mm.
- With the threaded rod FIS A, the loads to be applied can be designed variably by selecting the anchorage depth.
- Temporary and detachable fixing points are possible with the internal threaded anchor RG M I.
- For practical use on the building site, FIS EM Plus can be processed at low temperatures down to -5 °C.
- The mortar is approved for diamond-drilled and water-filled drill holes as well as seismic applications of performance categories C1, C2 and thus offers safety under extreme conditions.

APPLICATIONS

- Post-installed rebar connections
- Jointers for concrete layers
- Rim beam anchorings
- Seismic applications
- Anchorings in diamond-drilled or in waterfilled drill holes
- Heavy steel constructions
- Silo installations
- Tall shelving
- Sound barriers
- Temporary or removable fixings (with internal threaded anchor RG M I)

FUNCTIONING

- The epoxy mortar FIS EM Plus combined with the FIS A threaded rod, is suitable for pre-positioned and push-through installation and with the internal threaded anchor RG M I for pre-positioned installation.
- Resin and hardener are stored in two separate chambers and are not mixed and activated until extrusion through the injection capsule in the static mixer.
- The mortar is injected bubble-free from the drill hole base.
- The mortar bonds the entire surface of the anchor with the drill hole wall and seals off the drill hole.
- The anchor is set manually by lightly rotating it until it reaches the drill hole base.
- During push-through installation, the annular gap between the threaded rod and attachment is filled with FIS EM Plus.

SEE ALSO



ANCHORS + SLEEVES

Page 144



DISPENSER

Page 195

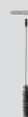

ACCESSORIES

Page 198

INSTALLATION IN CONCRETE WITH FIS EM PLUS AND FIS A / RG M

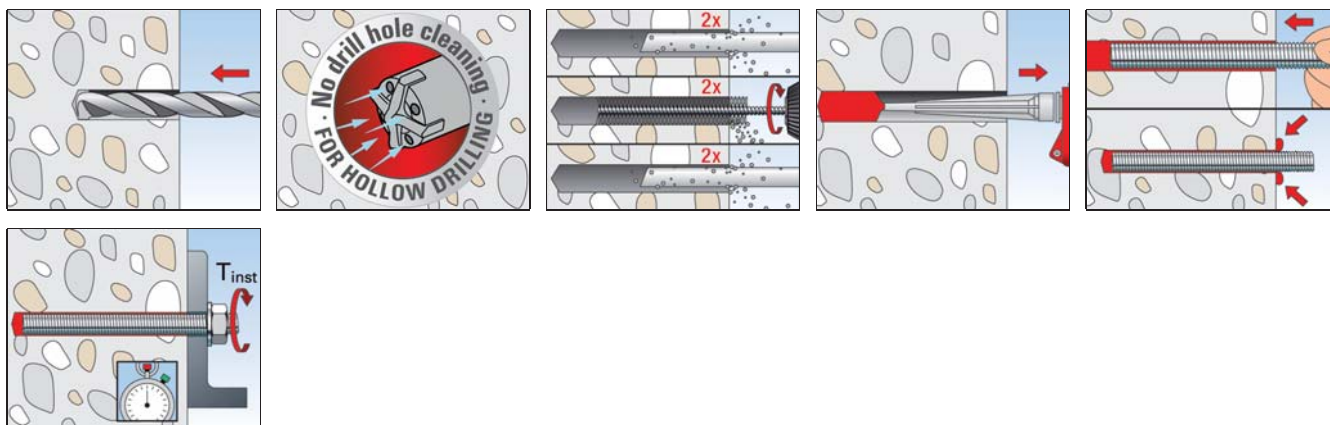

INSTALLATION IN CONCRETE WITH FIS EM PLUS AND RG M I

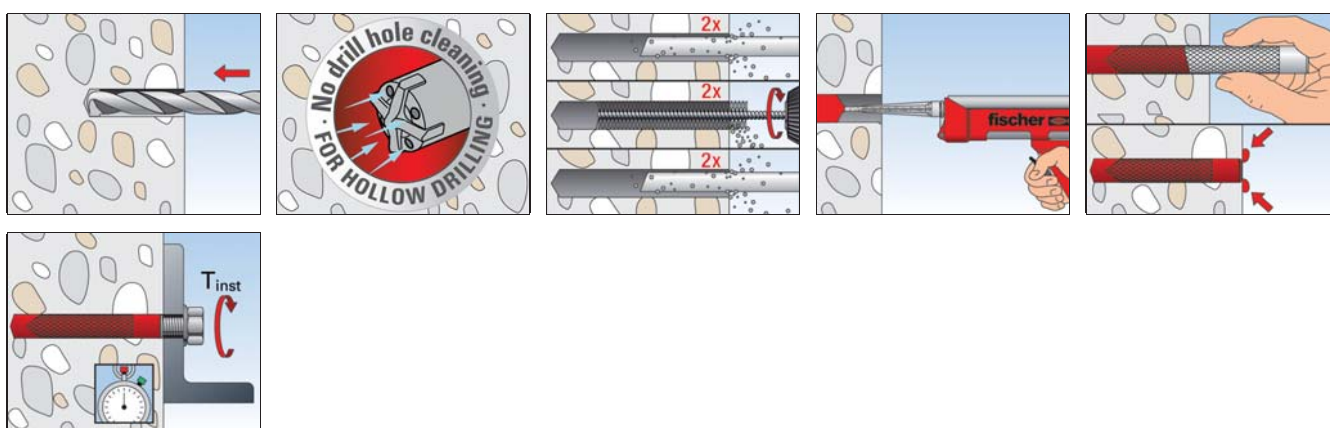

TECHNICAL DATA



Epoxy mortar
FIS EM Plus 390 S



Epoxy mortar
FIS EM Plus 585 S



Epoxy mortar
FIS EM Plus 1500 S

Item	Art.-No.	Approval			Languages on the cartridge	Scale unit	Contents	Sales unit
		DIBt	ETA	ICC				
FIS EM Plus 390 S	544154	●	■	▲	DE, EN, FR, NL, ES, PT	180	1 cartridge 390 ml, 2 x FIS MR Plus	6
FIS EM Plus 390 S	544155	●	■	▲	EN, ZH, EL, KO, HU, PL	180	1 cartridge 390 ml, 2 x FIS MR Plus	6
FIS EM Plus 390 S	544176	●	■	▲	CS, SK, RO, AR, FR, EN	180	1 cartridge 390 ml, 2 x FIS MR Plus	6
FIS EM Plus 390 S	544159	●	■	▲	LT, LV, ET, UK, RU, KK	180	1 cartridge 390 ml, 2 x FIS MR Plus	6
FIS EM Plus 585 S	544166	●	■	▲	DE, EN, FR, NL, ES, PT	270	1 cartridge 585 ml + 2 x FIS UMR	6
FIS EM Plus 585 S	544165	●	■	▲	EN, ZH, RU, KO, CS, PL	270	1 cartridge 585 ml + 2 x FIS UMR	6
FIS EM Plus 585 S	544175	●	■	▲	EN, ZH, RU, KO, CS, PL	270	1 cartridge 585 ml, 1 x FIS UMR, 1 x extension tube Ø 9x250 mm	6
FIS EM Plus 1500 S	544167	●	■	▲	DE, IT, FR, NL, CS, SK	700	1 cartridge 1500 ml, 2 x FIS UMR	4
FIS EM Plus 1500 S	544173	●	■	▲	EN, ES, PT, ZH, RU, PL	700	1 cartridge 1500 ml, 2 x FIS UMR	4

TECHNICAL DATA



Static mixer **FIS MR Plus**



Static mixer **FIS UMR**

Item	Art.-No.	Contents			Sales unit
					[pcs]
FIS MR Plus	545853			10 static mixer FIS MR Plus	10
FIS UMR	520593			10 static mixer FIS UMR for 585 ml and 1500 ml cartridges	10



FIS EM Plus 390 S HWK big



FIS EM Plus 390 S in bucket

Item	Art.-No.	Approval			Languages on the cartridge	Contents	Sales unit
		DIBt	ETA	ICC			[pcs]
FIS EM Plus 390 S HWK big	544156	●	■	▲	EN, ZH, EL, KO, HU, PL	20 cartridges 390 ml, 20 x FIS MR Plus	1
FIS EM Plus 390 S in bucket	544172	●	■	▲	DE, EN, FR, NL, ES, PT	20 cartridges 390 ml, 20 x FIS MR Plus	1

GELLING AND CURING TIME

Temperature at anchoring base	Gelling time	Curing time
- 5 °C to - 1 °C	180 min.	200 hrs.
0 °C to + 4 °C	150 min.	90 hrs.
+ 5 °C to + 9 °C	120 min.	40 hrs.
+ 10 °C to + 19 °C	30 min.	18 hrs.
+ 20 °C to + 29 °C	14 min.	10 hrs.
+ 30 °C to + 40 °C	7 min.	5 hrs.

The above times apply from the moment of contact between resin and hardener in the static mixer.

For installation, the cartridge temperature must be at least +5 °C. For longer installation times, i.e. when interruptions occur in work, the mixer should be replaced.

LOADS

Injection system FIS EM Plus: Injection resin FIS EM Plus with Threaded rod FIS A²⁾

zinc plated steel 5.8 / zinc plated steel 8.8 / stainless steel A4-70 / high corrosion resistant steel C-70

Permissible loads of a single anchor in cracked normal concrete (concrete tension zone) of strength clas C20/25 (~B25) ¹⁾³⁾⁴⁾⁸⁾										Minimum spacings while reducing the load	
Type	Material fixing element	Min. member thickness	Effective anchorage depth	Maximum torque moment	Permissible tensile load	Permissible shear load	Required edge distance (with one edge) for		Required spacing for	Min. spacing	Min. edge distance
		h_{min} [mm]	h_{ef} [mm]	T_{max} [Nm]	$N_{perm}^{5)}$ [kN]	$V_{perm}^{5)}$ [kN]	Max. tension load c [mm]	Max. shear load c [mm]	Max. Load s_{cr} [mm]		
FIS A M 8	5.8	100	60	10	5,4	5,1	90	105	180	40	40
		110	80		7,2		120	95	240		
		190	160		9,0		65	80	480		
	8.8	100	60		5,4	8,6	90	185	180		
		110	80		7,2		120	170	240		
		190	160		13,8		115	480			
	A4-70	100	60		5,4	6,0	90	125	180		
		110	80		7,2		120	115	240		
		190	160		9,9		75	90	480		
	C-70	100	60		5,4	7,4	90	160	180		
		110	80		7,2		120	145	240		
		190	160		12,4		105	105	480		
FIS A M 10	5.8	100	60	20	6,7	8,6	90	185	180	45	45
		120	90		10,1		135	155	270		
		230	200		13,8		70	110	600		
	8.8	100	60		6,7	13,1	90	295	180		
		120	90		10,1		135	250	270		
		230	200		22,4		150	150	600		
	A4-70	100	60		6,7	9,2	90	195	180		
		120	90		10,1		135	165	270		
		230	200		15,7		90	115	600		
	C-70	100	60		6,7	11,4	90	250	180		
		120	90		10,1		135	215	270		
		230	200		19,5		125	135	600		
FIS A M 12	5.8	100	70	40	10,0	12,0	105	255	210	55	45
		140	110		17,8		165	195	330		
		270	240		20,5		60	135	720		
	8.8	100	70		10,0	19,4	105	435	210		
		140	110		17,8		165	340	330		
		270	240		32,4		145	200	720		
	A4-70	100	70		10,0	13,7	105	295	210		
		140	110		17,8		165	230	330		
		270	240		22,5		75	150	720		
	C-70	100	70		10,0	17,1	105	380	210		
		140	110		17,8		165	295	330		
		270	240		28,1		115	175	720		
FIS A M 16	5.8	120	80	60	12,3	22,3	120	445	240	65	50
		170	125		24,0		190	350	375		
		360	320		37,6		95	195	960		
	8.8	120	80		12,3	24,5	120	495	240		
		170	125		24,0		190	600	375		
		360	320		60,0		225	320	960		
	A4-70	120	80		12,3	24,5	120	495	240		
		170	125		24,0		190	400	375		
		360	320		42,0		120	215	960		
	C-70	120	80		12,3	24,5	120	495	240		
		170	125		24,0		190	515	375		
		360	320		52,4		175	270	960		

LOADS

Injection system FIS EM Plus: Injection resin FIS EM Plus with Threaded rod FIS A²⁾

zinc plated steel 5.8 / zinc plated steel 8.8 / stainless steel A4-70 / high corrosion resistant steel C-70

Permissible loads of a single anchor in cracked normal concrete (concrete tension zone) of strength class C20/25 (~B25) ¹⁾³⁾⁴⁾⁸⁾										Minimum spacings while reducing the load					
Type	Material fixing element	Min. member thickness	Effective anchorage depth	Maximum torque moment	Permissible tensile load	Permissible shear load	Required edge distance (with one edge) for		Required spacing for	Min. spacing	Min. edge distance				
							Max. tension load c	Max. shear load c				Max. Load s _{cr}	s _{min} ⁶⁾	c _{min} ⁶⁾	
		h _{min} [mm]	h _{ef} [mm]	T _{max} [Nm]	N _{perm} ⁵⁾ [kN]	V _{perm} ⁵⁾ [kN]	[mm]	[mm]	[mm]	[mm]	[mm]				
FIS A M 20	5.8	140	90	120	14,6	29,3	135	530	270	85	55				
		220	170		38,0	34,9	255	455	510						
		450	400		58,6		115	260	1200						
	8.8	140	90		14,6	29,3	135	530	270						
		220	170		38,0	56,0	255	780	510						
		450	400		93,3		340	435	1200						
	A4-70	140	90		14,6	29,3	135	530	270						
		220	170		38,0	39,4	255	520	510						
		450	400		65,7		145	285	1200						
	C-70	140	90		14,6	29,3	135	530	270						
		220	170		38,0	49,1	255	675	510						
		450	400		81,9		265	370	1200						
FIS A M 24	5.8	160	96	150	16,1	32,2	145	545	290	105	60				
		270	210		52,2	50,9	315	590	630						
		540	480		84,3		160	330	1440						
	8.8	160	96		16,1	32,2	145	545	290						
		270	210		52,2	80,6	315	1005	630						
		540	480		134,3		475	570	1440						
	A4-70	160	96		16,1	32,2	145	545	290						
		270	210		52,2	56,8	315	670	630						
		540	480		94,3		230	360	1440						
	C-70	160	96		16,1	32,2	145	545	290						
		270	210		52,2	70,9	315	870	630						
		540	480		117,6		380	480	1440						
	FIS A M 27	5.8	170		108	200	19,2	38,5	165			610	325	120	75
			310		250		67,8	65,7	375			695	750		
			600		540		109,5		240			390	1620		
8.8		170	108	19,2	38,5		165	610	325						
		310	250	67,8	105,1		375	1200	750						
		600	540	175,2			615	700	1620						
A4-70		170	108	19,2	38,5		165	610	325						
		310	250	67,8	73,7		375	795	750						
		600	540	123,0			325	445	1620						
C-70		170	108	19,2	38,5		165	610	325						
		310	250	67,8	92,0		375	1030	750						
		600	540	153,3			500	595	1620						
FIS A M 30	5.8	190	120	300	22,5	45,1	180	665	360	140	80				
		350	280		80,3	80,6	420	795	840						
		670	600		133,8		300	440	1800						
	8.8	190	120		22,5	45,1	180	665	360						
		350	280		80,3	128,6	420	1375	840						
		670	600		213,8		725	805	1800						
	A4-70	190	120		22,5	45,1	180	665	360						
		350	280		80,3	90,2	420	910	840						
		670	600		150,1		395	510	1800						
	C-70	190	120		22,5	45,1	180	665	360						
		350	280		80,3	112,6	420	1180	840						
		670	600		187,1		595	680	1800						

For the design the complete assessment ETA-17/0979 has to be considered. ⁷⁾

¹⁾ The partial safety factors for material resistance as regulated in the ETA-17/0979 as well as a partial safety factor for load actions of $\gamma_L = 1,4$ are considered. As a single anchor counts e.g. an anchor with a spacing $s \geq 3 \cdot h_{ef}$ and an edge distance $c \geq 1,5 \cdot h_{ef}$. Accurate data see ETA-17/0979.

²⁾ Also valid for threaded rod RG M in the same property class.

³⁾ For higher concrete strength classes up to C50/60 higher permissible loads may be possible.

⁴⁾ Drill method hammer drilling resp. hollow drilling. For further allowable drill methods and application conditions see ETA-17/0979.

LOADS

Injection system FIS EM Plus: Injection resin FIS EM Plus with Threaded rod FIS A²⁾

zinc plated steel 5.8 / zinc plated steel 8.8 / stainless steel A4-70 / high corrosion resistant steel C-70

Permissible loads of a single anchor in cracked normal concrete (concrete tension zone) of strength class C20/25 (~B25) ¹⁾³⁾⁴⁾⁸⁾										Minimum spacings while reducing the load	
Type	Material fixing element	Min. member thickness	Effective anchorage depth	Maximum torque moment	Permissible tensile load	Permissible shear load	Required edge distance (with one edge) for		Required spacing for	Min. spacing	Min. edge distance
							Max. tension load c	Max. shear load c			
		h _{min} [mm]	h _{ef} [mm]	T _{max} [Nm]	N _{perm} ⁵⁾ [kN]	V _{perm} ⁵⁾ [kN]	[mm]	[mm]	[mm]	[mm]	[mm]

⁵⁾ For combinations of tensile loads and shear loads or for shear loads with lever arm (bending moments) as well as reduced edge distances or spacings (anchor groups) we recommend to use our anchor design software C-FIX.

⁶⁾ Minimum possible axial spacings resp. edge distance while reducing the permissible load.

⁷⁾ The given loads refer to the European Technical Assessment ETA-17/0979, issue date 06/04/2018. Design of the loads according to FprEN 1992-4:2017 and TR 055 (for static resp. quasi-static loads).

⁸⁾ A reinforcement in the concrete to prevent splitting is required. The width of the cracks has to be limited under consideration of the splitting forces at w_k ~0,3mm.

LOADS

Injection system FIS EM Plus: Injection resin FIS EM Plus with Threaded rod FIS A²⁾

zinc plated steel 5.8 / zinc plated steel 8.8 / stainless steel A4-70 / high corrosion resistant steel C-70

Permissible loads of a single anchor in non-cracked normal concrete (concrete compression zone) of strength class C20/25 (~B25) ¹⁾³⁾⁴⁾										Minimum spacings while reducing the load		
Type	Material fixing element	Min. member thickness	Effective anchorage depth	Maximum torque moment	Permissible tensile load	Permissible shear load	Required edge distance (with one edge) for		Required spacing for	Min. spacing	Min. edge distance	
							Max. tension load c	Max. shear load c				Max. Load s _{cr}
		h _{min} [mm]	h _{ef} [mm]	T _{max} [Nm]	N _{perm} ⁵⁾ [kN]	V _{perm} ⁵⁾ [kN]	[mm]	[mm]	[mm]	[mm]	[mm]	
FIS A M 8	5.8	100	60	10	9,0	5,1	75	70	180	40	40	
		110	80				55		240			
		190	160				40		480			
	8.8	100	60		11,2	8,6	100	130	180			
		110	80		13,8		130	115	240			
		190	160		40		90	480				
	A4-70	100	60		9,9	6,0	85	85	180			
		110	80				70	75	240			
		190	160				40	70	480			
	C-70	100	60		11,2	7,4	100	110	180			
		110	80				110	100	240			
		190	160				40	80	480			
FIS A M 10	5.8	100	60	20	11,2	8,6	100	125	180	45	45	
		120	90				13,8	110	105			270
		230	200				45	85	600			
	8.8	100	60		11,2	13,1	100	200	180			
		120	90		20,5		200	170	270			
		230	200		45		115	600				
	A4-70	100	60		11,2	9,2	100	135	180			
		120	90		15,7		140	110	270			
		230	200		45		90	600				
	C-70	100	60		11,2	11,4	100	170	180			
		120	90		19,5		190	145	270			
		230	200		45		105	600				
FIS A M 12	5.8	100	70	40	14,1	12,0	145	175	210	55	45	
		140	110				20,5	165	130			330
		270	240				45	100	720			
	8.8	100	70		14,1	19,4	145	295	210			
		140	110		27,7		250	230	330			
		270	240		32,4		45	150	720			
	A4-70	100	70		14,1	13,7	145	200	210			
		140	110		22,5		190	155	330			
		270	240		45		115	720				
	C-70	100	70		14,1	17,1	145	260	210			
		140	110		27,7		250	200	330			
		270	240		28,1		45	135	720			

LOADS

Injection system FIS EM Plus: Injection resin FIS EM Plus with Threaded rod FIS A²⁾

zinc plated steel 5.8 / zinc plated steel 8.8 / stainless steel A4-70 / high corrosion resistant steel C-70

Permissible loads of a single anchor in non-cracked normal concrete (concrete compression zone) of strength class C20/25 (~B25) ^{1) 3) 4)}										Minimum spacings while reducing the load		
Type	Material fixing element	Min. member thickness	Effective anchorage depth	Maximum torque moment	Permissible tensile load	Permissible shear load	Required edge distance (with one edge) for		Required spacing for	Min. spacing	Min. edge distance	
							Max. tension load c	Max. shear load c				Max. Load s _{cr}
		h _{min} [mm]	h _{ef} [mm]	T _{max} [Nm]	N _{perm} ⁵⁾ [kN]	V _{perm} ⁵⁾ [kN]	[mm]	[mm]	[mm]	[mm]	[mm]	
FIS A M 16	5.8	120	80	60	17,2	22,3	160	305	240	65	50	
		170	125		33,6		285	235	375			
		360	320		37,6		50	150	960			
	8.8	120	80		17,2	34,4	160	495	240			
		170	125		33,6	36,0	285	405	375			
		360	320		60,0	120	220	960				
	A4-70	120	80		17,2	25,2	160	350	240			
		170	125		33,6		285	270	375			
		360	320		42,0		50	165	960			
	C-70	120	80		17,2	31,4	160	445	240			
		170	125		33,6		285	350	375			
		360	320		52,4		50	195	960			
FIS A M 20	5.8	140	90	120	20,5	34,9	170	435	270	85	55	
		220	170		53,3		385	300	510			
		450	400		58,6		55	195	1200			
	8.8	140	90		20,5	41,1	170	525	270			
		220	170		53,3	56,0	385	510				
		450	400		93,3	230	290	1200				
	A4-70	140	90		20,5	39,4	170	500	270			
		220	170		53,3		385	350	510			
		450	400		65,7		55	215	1200			
	C-70	140	90		20,5	41,1	170	525	270			
		220	170		53,3	49,1	385	455	510			
		450	400		81,9	135	260	1200				
FIS A M 24	5.8	160	96	150	22,6	45,2	170	540	290	105	60	
		270	210		73,2		475	390	630			
		540	480		84,3		60	250	1440			
	8.8	160	96		22,6	45,2	170	540	290			
		270	210		73,2	80,6	475	675	630			
		540	480		134,3	360	365	1440				
	A4-70	160	96		22,6	45,2	170	540	290			
		270	210		73,2	56,8	475	445	630			
		540	480		94,3	60	270	1440				
	C-70	160	96		22,6	45,2	170	540	290			
		270	210		73,2	70,9	475	580	630			
		540	480		117,6	235	325	1440				
FIS A M 27	5.8	170	108	200	27,0	54,0	195	605	325	120	75	
		310	250		95,1		65,7	565	460			750
		600	540		109,5		75	295	1620			
	8.8	170	108		27,0	54,0	195	605	325			
		310	250		95,1	105,1	565	805	750			
		600	540		175,2	505	450	1620				
	A4-70	170	108		27,0	54,0	195	605	325			
		310	250		95,1	73,7	565	530	750			
		600	540		123,0	140	320	1620				
	C-70	170	108		27,0	54,0	195	605	325			
		310	250		95,1	92,0	565	690	750			
		600	540		153,3	355	385	1620				

Chemical fixings 3

LOADS

Injection system FIS EM Plus: Injection resin FIS EM Plus with Threaded rod FIS A²⁾

zinc plated steel 5.8 / zinc plated steel 8.8 / stainless steel A4-70 / high corrosion resistant steel C-70

Permissible loads of a single anchor in non-cracked normal concrete (concrete compression zone) of strength class C20/25 (~B25) ¹⁾³⁾⁴⁾										Minimum spacings while reducing the load	
Type	Material fixing element	Min. member thickness	Effective anchorage depth	Maximum torque moment	Permissible tensile load	Permissible shear load	Required edge distance (with one edge) for		Required spacing for	Min. spacing	Min. edge distance
							Max. tension load c	Max. shear load c			
		h _{min} [mm]	h _{ef} [mm]	T _{max} [Nm]	N _{perm} ⁵⁾ [kN]	V _{perm} ⁵⁾ [kN]	[mm]	[mm]	[mm]	[mm]	[mm]
FIS A M 30	5.8	190	120	300	31,6	63,2	210	660	360	140	80
		350	280		112,7	80,6	635	525	840		
		670	600		133,8		80	330	1800		
	8.8	190	120		31,6	63,2	210	660	360		
		350	280		112,7	128,6	635	920	840		
		670	600		213,8		610	515	1800		
	A4-70	190	120		31,6	63,2	210	660	360		
		350	280		112,7	90,2	635	605	840		
		670	600		150,1		195	365	1800		
	C-70	190	120		31,6	63,2	210	660	360		
		350	280		112,7	112,6	635	785	840		
		670	600		187,1		445	435	1800		

For the design the complete assessment ETA-17/0979 has to be considered. ⁷⁾

¹⁾ The partial safety factors for material resistance as regulated in the ETA-17/0979 as well as a partial safety factor for load actions of $\gamma_L = 1,4$ are considered. As a single anchor counts e.g. an anchor with a spacing $s \geq 3 \cdot h_{ef}$ and an edge distance $c \geq 1,5 \cdot h_{ef}$. Accurate data see ETA-17/0979.

²⁾ Also valid for threaded rod RG M in the same property class.

³⁾ For higher concrete strength classes up to C50/60 higher permissible loads may be possible.

⁴⁾ Drill method hammer drilling resp. hollow drilling. For further allowable drill methods and application conditions see ETA-17/0979.

⁵⁾ For combinations of tensile loads and shear loads or for shear loads with lever arm (bending moments) as well as reduced edge distances or spacings (anchor groups) we recommend to use our anchor design software C-FIX.

⁶⁾ Minimum possible axial spacings resp. edge distance while reducing the permissible load.

⁷⁾ The given loads refer to the European Technical Assessment ETA-17/0979, issue date 06/04/2018. Design of the loads according to FprEN 1992-4:2017 and TR 055 (for static resp. quasi-static loads).

LOADS

Injection system FIS EM Plus: Injection resin FIS EM Plus with Internal threaded anchor RG M I

zinc plated steel / stainless steel A4

Permissible loads of a single anchor in cracked normal concrete (concrete tension zone) of strength class C20/25 (~ B25) ¹⁾²⁾³⁾⁷⁾										Minimum spacings while reducing the load	
Type	Screw steel property/surface	Min. member thickness	Effective anchorage depth	Maximum torque moment	Permissible tensile load	Permissible shear load	Required edge distance (with one edge) for		Required spacing for	Min. spacing	Min. edge distance
							Max. tension load c	Max. shear load c			
		h _{min} [mm]	h _{ef} [mm]	T _{max} [Nm]	N _{perm} ⁴⁾ [kN]	V _{perm} ⁴⁾ [kN]	[mm]	[mm]	[mm]	[mm]	[mm]
RG M8 I	5.8	120	90	10	9,0	5,3	100	85	270	55	55
	8.8				11,3	8,3	135	145			
	A4-70				9,9	5,9	115	95			
RG M10 I	5.8	130	90	20	12,9	8,3	135	135	270	65	65
	8.8					13,3		235			
	A4-70					9,3		155			
RG M12 I	5.8	170	125	40	20,2	12,1	190	165	375	75	75
	8.8					19,3		285			
	A4-70					13,5		185			
RG M16 I	5.8	210	160	80	34,7	22,4	240	275	480	95	95
	8.8					30,9		405			
	A4-70					25,1		315			
RG M20 I	5.8	270	200	120	48,5	35,4	300	380	600	125	125
	8.8					42,9		480			
	A4-70					39,4		430			

LOADS

Injection system FIS EM Plus: Injection resin FIS EM Plus with Internal threaded anchor RG M I
zinc plated steel / stainless steel A4

Permissible loads of a single anchor in cracked normal concrete (concrete tension zone) of strength class C20/25 (~ B25) ¹⁾²⁾³⁾⁷⁾										Minimum spacings while reducing the load	
Type	Screw steel property/surface	Min. member thickness	Effective anchorage depth	Maximum torque moment	Permissible tensile load	Permissible shear load	Required edge distance (with one edge) for		Required spacing for	Min. spacing	Min. edge distance
							Max. tension load c	Max. shear load c			
		h _{min} [mm]	h _{ef} [mm]	T _{max} [Nm]	N _{perm} ⁴⁾ [kN]	V _{perm} ⁴⁾ [kN]	[mm]	[mm]	[mm]	[mm]	[mm]

For the design the complete assessment ETA-17/0979 has to be considered. ⁶⁾

¹⁾ The partial safety factors for material resistance as regulated in the ETA-17/0979 as well as a partial safety factor for load actions of $\gamma_L = 1,4$ are considered. As a single anchor counts e.g. an anchor with a spacing $s \geq 3 \cdot h_{ef}$ and an edge distance $c \geq 1,5 \cdot h_{ef}$. Accurate data see ETA-17/0979.

²⁾ For higher concrete strength classes up to C50/60 higher permissible loads may be possible.

³⁾ Drill method hammer drilling resp. hollow drilling. For further allowable drill methods and application conditions see ETA-17/0979.

⁴⁾ For combinations of tensile loads and shear loads or for shear loads with lever arm (bending moments) as well as reduced edge distances or spacings (anchor groups) we recommend to use our anchor design software C-FIX.

⁵⁾ Minimum possible axial spacings resp. edge distance while reducing the permissible load.

⁶⁾ The given loads refer to the European Technical Assessment ETA-17/0979, issue date 06/04/2018. Design of the loads according to FprEN 1992-4:2017 and TR 055 (for static resp. quasi-static loads).

⁷⁾ A reinforcement in the concrete to prevent splitting is required. The width of the cracks has to be limited under consideration of the splitting forces at $w_k \sim 0,3$ mm.

LOADS

Injection system FIS EM Plus: Injection resin FIS EM Plus with Internal threaded anchor RG M I
zinc plated steel / stainless steel A4

Permissible loads of a single anchor in non-cracked normal concrete (concrete compression zone) of strength class C20/25 (~ B25) ¹⁾²⁾³⁾										Minimum spacings while reducing the load	
Type	Screw steel property/surface	Min. member thickness	Effective anchorage depth	Maximum torque moment	Permissible tensile load	Permissible shear load	Required edge distance (with one edge) for		Required spacing for	Min. spacing	Min. edge distance
							Max. tension load c	Max. shear load c			
		h _{min} [mm]	h _{ef} [mm]	T _{max} [Nm]	N _{perm} ⁴⁾ [kN]	V _{perm} ⁴⁾ [kN]	[mm]	[mm]	[mm]	[mm]	[mm]
RG M8 I	5.8	120	90	10	9,0	5,3	55	65	270	55	55
	8.8				13,8	8,3	110	95			
	A4-70				9,9	5,9	55	70			
RG M10 I	5.8	130	90	20	13,8	8,3	105	90	270	65	65
	8.8				20,5	13,3	190	155			
	A4-70				15,7	9,3	130	100			
RG M12 I	5.8	170	125	40	20,5	12,1	130	110	375	75	75
	8.8				32,4	19,3	265	190			
	A4-70				22,5	13,5	155	125			
RG M16 I	5.8	210	160	80	37,6	22,4	255	180	480	95	95
	8.8				48,7	30,9	365	265			
	A4-70				42,0	25,1	300	205			
RG M20 I	5.8	270	200	120	58,6	35,4	365	245	600	125	125
	8.8				68,0	42,9	445	315			
	A4-70				65,7	39,4	430	285			

For the design the complete assessment ETA-17/0979 has to be considered. ⁶⁾

¹⁾ The partial safety factors for material resistance as regulated in the ETA-17/0979 as well as a partial safety factor for load actions of $\gamma_L = 1,4$ are considered. As a single anchor counts e.g. an anchor with a spacing $s \geq 3 \cdot h_{ef}$ and an edge distance $c \geq 1,5 \cdot h_{ef}$. Accurate data see ETA-17/0979.

²⁾ For higher concrete strength classes up to C50/60 higher permissible loads may be possible.

³⁾ Drill method hammer drilling resp. hollow drilling. For further allowable drill methods and application conditions see ETA-17/0979.

⁴⁾ For combinations of tensile loads and shear loads or for shear loads with lever arm (bending moments) as well as reduced edge distances or spacings (anchor groups) we recommend to use our anchor design software C-FIX.

⁵⁾ Minimum possible axial spacings resp. edge distance while reducing the permissible load.

⁶⁾ The given loads refer to the European Technical Assessment ETA-17/0979, issue date 06/04/2018. Design of the loads according to FprEN 1992-4:2017 and TR 055 (for static resp. quasi-static loads).

The basic epoxy mortar for applications in concrete



Crash barriers and sound insulation walls



Rebar connections

BUILDING MATERIALS

Approved for anchorings in:

- Concrete C20/25, cracked and non-cracked

CERTIFICATES

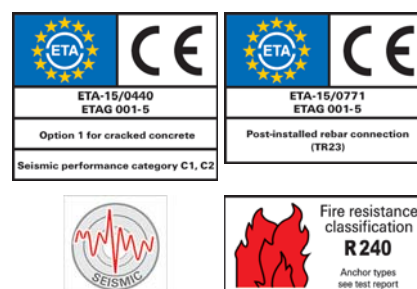

ADVANTAGES

- FIS EB is approved for use in cracked concrete and for rebar applications and achieves a good performance in these applications which enables an economical use of injection mortar.
- Variable anchorage depths from 4xd to 20xd allow for ideal adaptation to the load to be applied.
- FIS EB can be used in various conditions (dry/wet concrete, flooded hole), thus working in almost all situations on the building site and making it a safe and reliable system.

APPLICATIONS

- Heavy steel constructions
- Consoles
- Silo installations
- Tall shelving
- Post-installed rebar connections

FUNCTIONING

- The epoxy mortar FIS EB combined with the threaded rod FIS A is suitable for pre-positioned and push-through installation.
- Resin and hardener are stored in two separate chambers and are not mixed and activated until extrusion through the injection capsule in the static mixer.
- The mortar is injected bubble-free from the drill hole base.
- The mortar bonds the entire surface of the threaded rod with the drill hole wall and seals off the drill hole.
- The threaded rod is set manually by slightly rotating it until it reached the drill hole base.
- During push-through installation, the annular gap between the threaded rod and the attachment is filled with FIS EB.

SEE ALSO



ANCHORS + SLEEVES

Page 144



DISPENSER

Page 195



ACCESSORIES

Page 198

INSTALLATION IN CONCRETE WITH FIS EB AND FIS A / RG M

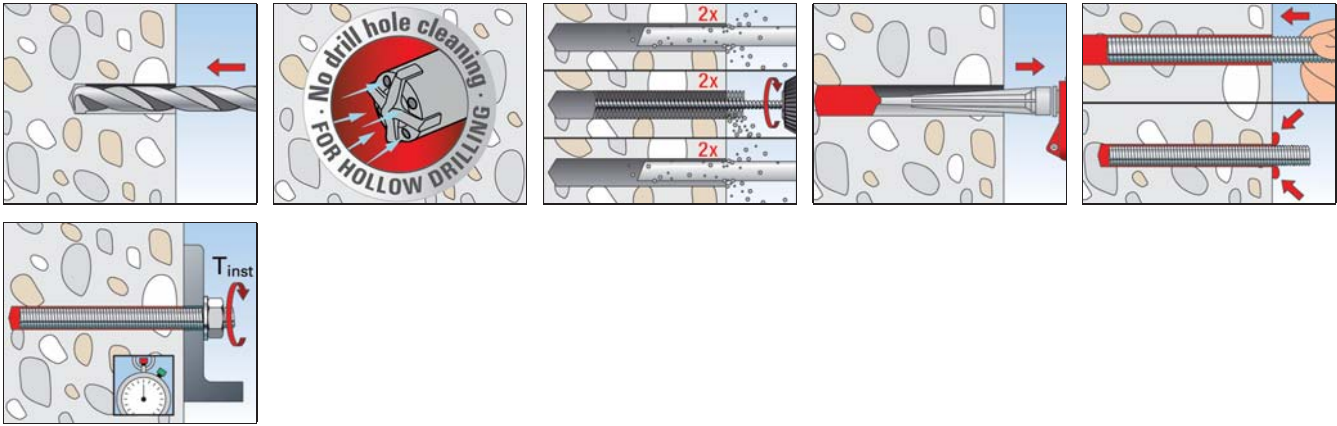

TECHNICAL DATA



Epoxy mortar **FIS EB**



Static mixer **FIS MR Plus**

Item	Art.-No.	Approval ETA	Languages on the cartridge	Scale unit	Contents	Sales unit [pcs]
FIS EB 390 S	534984	■	EN, ES, PT	180	1 cartridge 390 ml, 2 x FIS MR Plus	6
FIS EB 390 S	534985	■	TR, RU, KO	180	1 cartridge 390 ml, 2 x FIS MR Plus	6
FIS EB 390 S in bucket	543652	■	EN, ES, PT	180	20 cartridges 390 ml, 20 x FIS MR Plus	1
FIS EB 390 S in bucket	538547	■	TR, RU, KO	180	20 cartridges 390 ml, 20 x FIS MR Plus	1
FIS EB 585 S	534986	■	EN, ES, PT, NL	270	1 cartridge 585 ml + 2 x FIS UMR	6
FIS MR Plus	545853	—	—	—	10 static mixer FIS MR Plus	10

LOADS

Injection system FIS EB: Injection mortar FIS EB with Threaded rod FIS A ¹⁾

zinc plated steel 5.8 / zinc plated steel 8.8 / stainless steel A4-70

Permissible loads of a single anchor in cracked normal concrete (concrete tension zone) of strength class C20/25 (~B25) ^{2) 3) 4) 9)}										Minimum spacings while reducing the load	
Type	Material fixing element	Min. member thickness	Effective anchorage depth	Maximum torque moment	Permissible tensile load	Permissible shear load	Required edge distance (with one edge) for		Required spacing for	Min. spacing	Min. edge distance
							Max. tension load c	Max. shear load c			
		h _{min} [mm]	h _{ef} ⁵⁾ [mm]	T _{max} [Nm]	N _{perm} ⁶⁾ [kN]	V _{perm} ⁶⁾ [kN]	[mm]	[mm]	[mm]	[mm]	[mm]
FIS A M8	5.8	100	60	10	3,6	5,1	90	105	180	40	40
		110	80		4,8		100	100	240		
		190	160		9,0		90	90	480		
	8.8	100	60		3,6	7,2	100	155	180		
		110	80		4,8	8,6		170	240		
		190	160		9,6	115		480			
	A4-70	100	60		3,6	6,0	90	125	180		
		110	80		4,8		100	115	240		
		190	160		9,6		90	90	480		
FIS A M10	5.8	100	60	20	4,5	8,6	90	185	180	45	45
		120	90		6,7		115	160	270		
		230	200		13,8		105	125	600		
	8.8	100	60		4,5	9,0	90	190	180		
		120	90		6,7	13,1	115	250	270		
		230	200		15,0	150	600				
	A4-70	100	60		4,5	9,0	90	190	180		
		120	90		6,7	9,2	115	165	270		
		230	200		15,0		115	115	600		

LOADS

Injection system FIS EB: Injection mortar FIS EB with Threaded rod FIS A ¹⁾

zinc plated steel 5.8 / zinc plated steel 8.8 / stainless steel A4-70

Permissible loads of a single anchor in cracked normal concrete (concrete tension zone) of strength class C20/25 (~B25) ^{2) 3) 4) 9)}										Minimum spacings while reducing the load	
Type	Material fixing element	Min. member thickness	Effective anchorage depth	Maximum torque moment	Permissible tensile load	Permissible shear load	Required edge distance (with one edge) for		Required spacing for	Min. spacing	Min. edge distance
		h_{min} [mm]	$h_{ef}^{5)}$ [mm]	T_{max} [Nm]	$N_{perm}^{6)}$ [kN]	$V_{perm}^{6)}$ [kN]	Max. tension load c [mm]	Max. shear load c [mm]	Max. Load s_{cr} [mm]		
FIS A M12	5.8	100	70	40	6,3	12,0	105	255	210	55	55
		140	110		9,9		140	200	330		
		270	240		20,5		130	150	720		
	8.8	100	70		6,3	12,6	105	270	210		
		140	110		9,9	19,4	140	340	330		
		270	240		21,5		200	720			
	A4-70	100	70		6,3	12,6	105	270	210		
		140	110		9,9	13,7	140	230	330		
		270	240		21,5		150	720			
FIS A M14	5.8	110	75	50	7,9	16,6	115	325	225	60	60
		160	120		12,6		155	265	360		
		320	280		27,6		145	185	840		
	8.8	110	75		7,9	15,7	115	325	225		
		160	120		12,6	25,1	155	420	360		
		320	280		29,3		250	840			
	A4-70	110	75		7,9	15,7	115	325	225		
		160	120		12,6	18,3	155	295	360		
		320	280		29,3		175	840			
FIS A M16	5.8	120	80	60	7,7	22,3	120	295	240	65	65
		170	125		12,0		175	350	375		
		360	320		30,6		225	960			
	8.8	120	80		7,7	15,3	120	295	240		
		170	125		12,0	23,9	175	380	375		
		360	320		30,6		36,0	320	960		
	A4-70	120	80		7,7	15,3	120	295	240		
		170	125		12,0	23,9	175	380	375		
		360	320		30,6		25,2	215	960		
FIS A M20	5.8	140	90	120	10,8	34,9	135	375	270	85	85
		220	170		20,3		210	460	510		
		450	400		47,9		300	1200			
	8.8	140	90		10,8	21,5	135	375	270		
		220	170		20,3	40,7	210	540	510		
		450	400		47,9		56,0	435	1200		
	A4-70	140	90		10,8	21,5	135	375	270		
		220	170		20,3	39,4	210	520	510		
		450	400		47,9		285	1200			
FIS A M24	5.8	160	96	150	13,4	50,9	145	545	290	105	105
		270	210		31,4		250	600	630		
		540	480		71,8		395	1440			
	8.8	160	96		13,4	32,2	145	545	290		
		270	210		31,4	75,4	250	930	630		
		540	480		71,8		80,6	570	1440		
	A4-70	160	96		13,4	32,2	145	545	290		
		270	210		31,4	56,8	250	670	630		
		540	480		71,8		360	1440			

LOADS

Injection system FIS EB: Injection mortar FIS EB with Threaded rod FIS A ¹⁾

zinc plated steel 5.8 / zinc plated steel 8.8 / stainless steel A4-70

Permissible loads of a single anchor in cracked normal concrete (concrete tension zone) of strength class C20/25 (~B25) ^{2) 3) 4) 9)}										Minimum spacings while reducing the load					
Type	Material fixing element	Min. member thickness	Effective anchorage depth	Maximum torque moment	Permissible tensile load	Permissible shear load	Required edge distance (with one edge) for		Required spacing for	Min. spacing	Min. edge distance				
		h_{min} [mm]	$h_{ef}^{5)}$ [mm]	T_{max} [Nm]	$N_{perm}^{6)}$ [kN]	$V_{perm}^{6)}$ [kN]	Max. tension load c [mm]	Max. shear load c [mm]	Max. Load s_{cr} [mm]	$s_{min}^{7)}$ [mm]	$c_{min}^{7)}$ [mm]				
FIS A M27	5.8	170	108	200	16,0	38,5	165	610	325	120	120				
		310	250		42,1	65,7	270	715	750						
		600	540		90,9			485	1620						
	8.8	170	108		16,0	38,5	165	610	325						
		310	250		42,1	101,0	270	1150	750						
		600	540		90,9	105,1	700	1620							
	A4-70	170	108		16,0	38,5	165	610	325						
		310	250		42,1	73,7	270	795	750						
		600	540		90,9			445	1620						
	FIS A M30	5.8	190		120	300	18,8	45,1	180			665	360	140	140
			350		280		52,4	80,6	300			820	840		
			670		600		112,2					305	555		
8.8		190	120	18,8	45,1		180	665	360						
		350	280	52,4	125,7		300	1340	840						
		670	600	112,2	128,6		305	805	1800						
A4-70		190	120	18,8	45,1		180	665	360						
		350	280	52,4	90,2		300	910	840						
		670	600	112,2				305	510	1800					

For the design the complete assessment ETA-15/0440 has to be considered. ⁸⁾

¹⁾ Also valid for threaded rod RG M in the same property class.

²⁾ The partial safety factors for material resistance as regulated in the ETA-15/0440 as well as a partial safety factor for load actions of $\gamma_L = 1,4$ bare considered. As an single anchor counts e.g. an anchor with a spacing $s \geq 3 \cdot h_{ef}$ and an edge distance $c \geq 1,5 \cdot h_{ef}$. Accurate data see ETA-15/0440.

³⁾ For higher concrete strength classes up to C50/60 higher permissible loads may be possible.

⁴⁾ Drill method hammer drilling. For further allowable drill methods and application conditions see ETA-15/0440.

⁵⁾ For the sizes M8 - M30 the min. anchorage depth and the max. anchorage depth are given. The anchorage depth can be chosen freely between these borders.

⁶⁾ For combinations of tensile loads and shear loads or for shear loads with lever arm (bending moments) as well as reduced edge distances or spacings (anchor groups) we recommend to use our anchor design software C-FIX.

⁷⁾ Minimum possible axial spacings resp. edge distance while reducing the permissible load.

⁸⁾ The given loads refer to the European Technical Assessment ETA-15/0440, issue date 06/07/2015. Design of the loads according ETAG 001, Technical Report TR 029 (for static resp. quasi-static loads).

⁹⁾ A reinforcement in the concrete to prevent splitting is required. The width of the cracks has to be limited under consideration of the splitting forces at $w_k \sim 0,3$ mm.

LOADS

Injection system FIS EB: Injection mortar FIS EB with Threaded rod FIS A ¹⁾

zinc plated steel 5.8 / zinc plated steel 8.8 / stainless steel A4-70

Permissible loads of a single anchor in non-cracked normal concrete (concrete compression zone) of strength class C20/25 (~B25) ²⁾³⁾⁴⁾										Minimum spacings while reducing the load	
Type	Material fixing element	Min. member thickness	Effective anchorage depth	Maximum torque moment	Permissible tensile load	Permissible shear load	Required edge distance (with one edge) for		Required spacing for	Min. spacing	Min. edge distance
		h_{min} [mm]	$h_{ef}^{5)}$ [mm]	T_{max} [Nm]	$N_{perm}^{6)}$ [kN]	$V_{perm}^{6)}$ [kN]	Max. tension load c [mm]	Max. shear load c [mm]	Max. Load s_{cr} [mm]		
FIS A M8	5.8	100	60	10	7,9	5,1	90	70	180	40	40
		110	80		9,0		80		240		
		190	160		40		480				
	8.8	100	60		7,9	8,6	90	130	180		
		110	80		10,5		100	115	240		
		190	160		13,8		50	90	480		
	A4-70	100	60		7,9	6,0	90	85	180		
		110	80		9,9		75	240			
		190	160		40		70	480			
FIS A M10	5.8	100	60	20	9,0	8,6	90	125	180	45	45
		120	90		13,5		115	105	270		
		230	200		13,8		45	95	600		
	8.8	100	60		9,0	13,1	90	200	180		
		120	90		13,5		115	170	270		
		230	200		22,4		80	115	600		
	A4-70	100	60		9,0	9,2	90	135	180		
		120	90		13,5		115	110	270		
		230	200		15,7		45	90	600		
FIS A M12	5.8	100	70	40	12,6	12,0	125	175	210	55	55
		140	110		19,7		155	135	330		
		270	240		20,5		55	120	720		
	8.8	100	70		12,6	19,4	125	295	210		
		140	110		19,7		155	230	330		
		270	240		32,4		95	150	720		
	A4-70	100	70		12,6	13,7	125	200	210		
		140	110		19,7		155	155	330		
		270	240		22,5		55	115	720		
FIS A M14	5.8	110	75	50	14,1	16,6	135	235	225	60	60
		160	120		22,6		170	180	360		
		320	280		27,6		60	145	840		
	8.8	110	75		14,1	26,3	135	390	225		
		160	120		22,6		170	300	360		
		320	280		43,8		120	180	840		
	A4-70	110	75		14,1	18,3	135	260	225		
		160	120		22,6		170	195	360		
		320	280		30,9		65	135	840		
FIS A M16	5.8	120	80	60	17,2	22,3	160	305	240	65	65
		170	125		26,9		210	235	375		
		360	320		37,6		65	175	960		
	8.8	120	80		17,2	34,4	160	495	240		
		170	125		26,9		210	405	375		
		360	320		60,0		150	220	960		
	A4-70	120	80		17,2	25,2	160	350	240		
		170	125		26,9		210	270	375		
		360	320		42,0		80	165	960		

LOADS

Injection system FIS EB: Injection mortar FIS EB with Threaded rod FIS A ¹⁾

zinc plated steel 5.8 / zinc plated steel 8.8 / stainless steel A4-70

Permissible loads of a single anchor in non-cracked normal concrete (concrete compression zone) of strength class C20/25 (~B25) ^{2) 3) 4)}										Minimum spacings while reducing the load						
Type	Material fixing element	Min. member thickness	Effective anchorage depth	Maximum torque moment	Permissible tensile load	Permissible shear load	Required edge distance (with one edge) for		Required spacing for	Min. spacing	Min. edge distance					
							Max. tension load c	Max. shear load c				Max. Load s _{cr}	s _{min} ⁷⁾	c _{min} ⁷⁾		
		h _{min} [mm]	h _{ef} ⁵⁾ [mm]	T _{max} [Nm]	N _{perm} ⁶⁾ [kN]	V _{perm} ⁶⁾ [kN]	[mm]	[mm]	[mm]	[mm]	[mm]					
FIS A M20	5.8	140	90	120	20,5	34,9	170	435	270	85	85					
		220	170		40,7		265	305	510							
		450	400		58,6		95	230	1200							
	8.8	140	90		20,5	41,1	170	525	270							
		220	170		40,7	56,0	265	510	510							
		450	400		93,3	230	290	1200								
	A4-70	140	90		20,5	39,4	170	500	270							
		220	170		40,7		265	350	510							
		450	400		65,7		120	215	1200							
	FIS A M24	5.8	160		96	150	18,8	45,2	170			540	290	105	105	
			270		210		50,3		370			400	630			
			540		480		84,3		160			295	1440			
8.8		160	96	18,8	45,2		170	540	290							
		270	210	50,3	80,6		370	675	630							
		540	480	114,9	385		365	1440								
A4-70		160	96	18,8	45,2		170	540	290							
		270	210	50,3	56,8		370	445	630							
		540	480	94,3	205		270	1440								
FIS A M27		5.8	170	108	200		22,5	54,0	195	605	325	120	120			
			310	250			63,1		65,7	415	475					750
			600	540			109,5		200	345	1620					
	8.8	170	108	22,5		54,0	195	605	325							
		310	250	63,1		105,1	415	805	750							
		600	540	136,3		425	450	1620								
	A4-70	170	108	22,5		54,0	195	605	325							
		310	250	63,1		73,7	415	530	750							
		600	540	123,0		315	320	1620								
	FIS A M30	5.8	190	120		300	26,3	63,2	210	660	360			140	140	
			350	280			78,5		80,6	500	545					840
			670	600			133,8		270	395	1800					
8.8		190	120	26,3	63,2		210	660	360							
		350	280	78,5	128,6		500	920	840							
		670	600	168,3	540		515	1800								
A4-70		190	120	26,3	63,2		210	660	360							
		350	280	78,5	90,2		500	605	840							
		670	600	150,1	400		365	1800								

For the design the complete assessment ETA-15/0440 has to be considered. ⁸⁾

¹⁾ Also valid for threaded rod RG M in the same property class.

²⁾ The partial safety factors for material resistance as regulated in the ETA-15/0440 as well as a partial safety factor for load actions of $\gamma_L = 1,4$ bare considered. As an single anchor counts e.g. an anchor with a spacing $s \geq 3 \cdot h_{ef}$ and an edge distance $c \geq 1,5 \cdot h_{ef}$. Accurate data see ETA-15/0440.

³⁾ For higher concrete strength classes up to C50/60 higher permissible loads may be possible.

⁴⁾ Drill method hammer drilling. For further allowable drill methods and application conditions see ETA-15/0440.

⁵⁾ For the sizes M8 - M30 the min. anchorage depth and the max. anchorage depth are given. The anchorage depth can be chosen freely between these borders.

⁶⁾ For combinations of tensile loads and shear loads or for shear loads with lever arm (bending moments) as well as reduced edge distances or spacings (anchor groups) we recommend to use our anchor design software C-FIX.

⁷⁾ Minimum possible axial spacings resp. edge distance while reducing the permissible load.

⁸⁾ The given loads refer to the European Technical Assessment ETA-15/0440, issue date 06/07/2015. Design of the loads according ETAG 001, Technical Report TR 029 (for static resp. quasi-static loads).

The versatile injection mortar for anchorings in masonry and cracked concrete

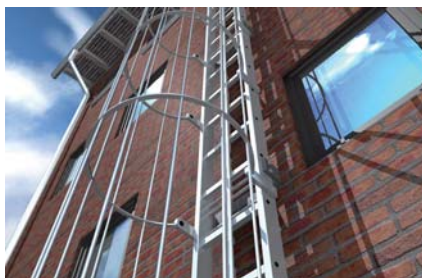

Rescue ladders



Column bases

BUILDING MATERIALS

Approved for anchorings in:

- Concrete C20/25 to C50/60, cracked and non-cracked
- Hollow blocks made from lightweight concrete
- Hollow blocks made from concrete
- Vertically perforated brick
- Perforated sand-lime brick
- Solid sand-lime brick
- Aerated concrete
- Solid brick

Approved for:

- Rebar connections
- Remedial wall tie VBS 8
- Weather facing reconstruction system FWS II
- Stand-off installation Thermax

CERTIFICATES

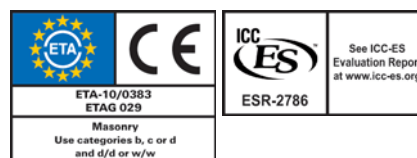

ADVANTAGES

- The FIS V injection mortar has numerous system approvals, such as in cracked and non-cracked concrete, masonry and for special applications. FIS V is thus the universal injection mortar family with guaranteed reliability for practically all areas of application.
- FIS VW HIGH SPEED has a significantly shorter curing time than FIS V, thus also ensuring swift work progress even at low temperatures.
- FIS VS LOW SPEED with extended gelling time prevents premature curing of the mortar at higher temperatures and is ideally suited to large drill hole depths.
- The extensive range of accessories is ideally suited to the FIS V injection mortar family, increases the great flexibility of the system and thus allows for a broad range of applications.

APPLICATIONS

Injection mortar for use with:

- Threaded rods FIS A, see page 146
- Internal threaded anchor RG MI, see page 159
- Rebar anchor FRA, see page 179
- Concrete steel bars, see page 185
- Injection anchor sleeves FIS H, see page 167
- Aerated concrete centring sleeve PBZ, see page PL
- Remedial wall tie VBS 8, see page 187
- Weather facing reconstruction system FWS II, see page 189
- Anchorings in waterfilled drill holes (only FIS V 410 C)

FUNCTIONING

- The FIS V is a 2-component injection mortar based on vinyl ester hybrid.
- Resin and hardener are stored in two separate chambers and are not mixed and activated until extrusion through the static mixer.
- The injection cartridges are quick and easy to use with the fischer dispensers.
- Partially used cartridges can be reused, simply by changing the static mixer.

SEE ALSO



ANCHORS + SLEEVES

Page 144



DISPENSER

Page 195



ACCESSORIES

Page 198

INSTALLATION IN CONCRETE WITH FIS V AND FIS A / RG M

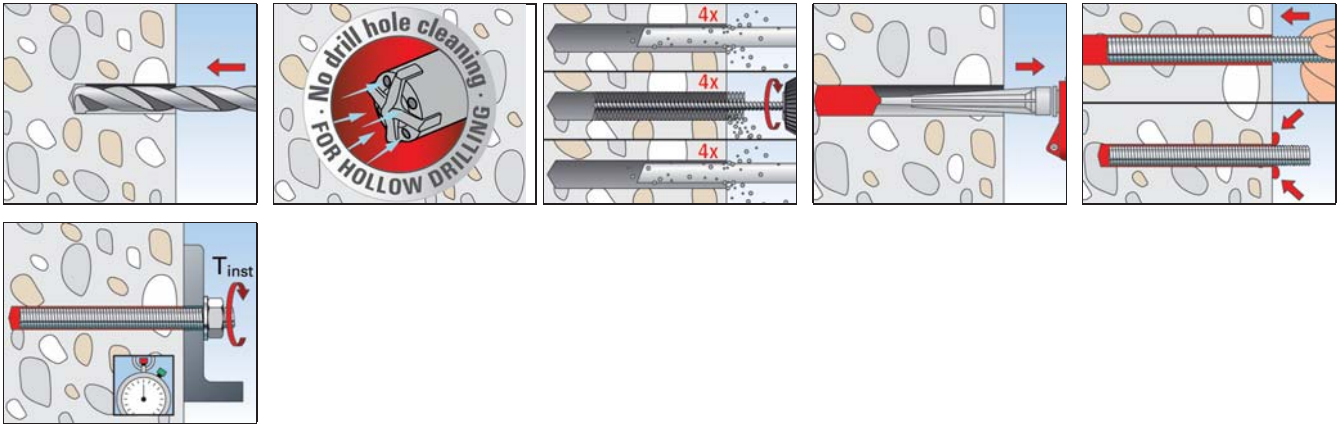

INSTALLATION IN CONCRETE WITH FIS V AND RG M I

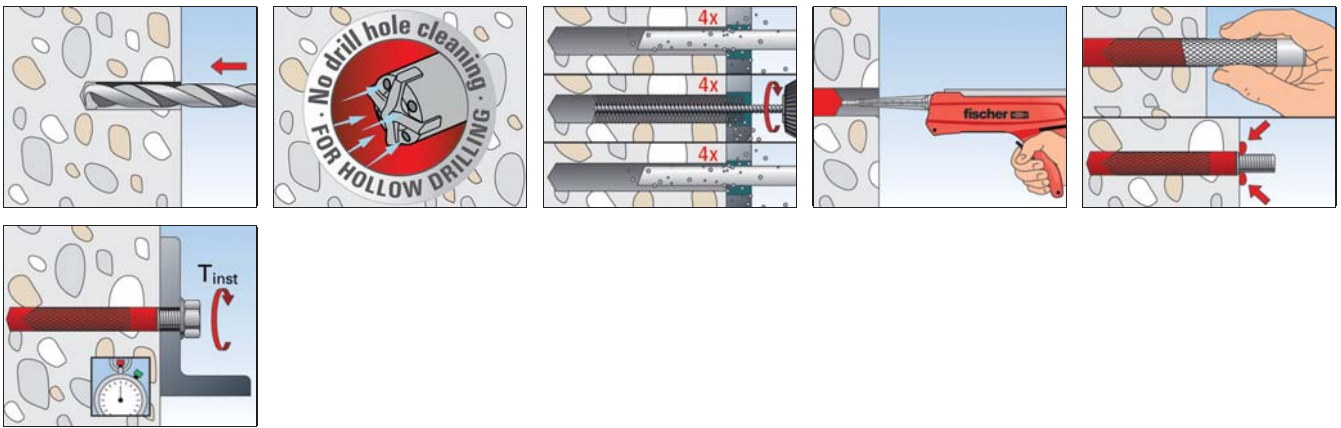

INSTALLATION IN SOLID BRICK WITH FIS V AND FIS A

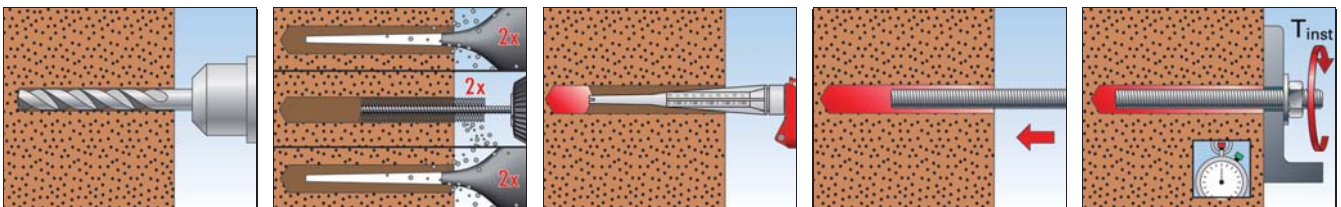

INSTALLATION IN HOLLOW BLOCKS WITH FIS V AND FIS HK + FIS A

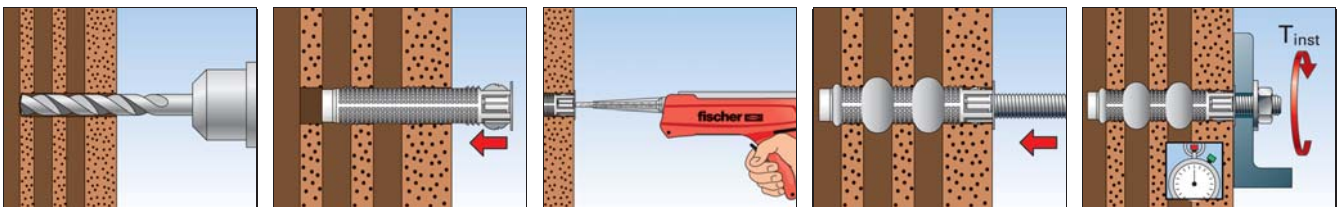

INSTALLATION IN AERATED CONCRETE WITH FIS V AND FIS A / RG M

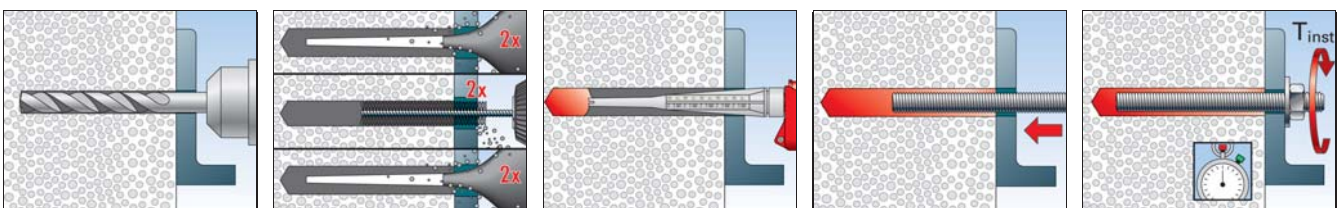

INSTALLATION IN UNDERCUT DRILL HOLE IN AERATED CONCRETE WITH FIS V AND FIS A / RG M

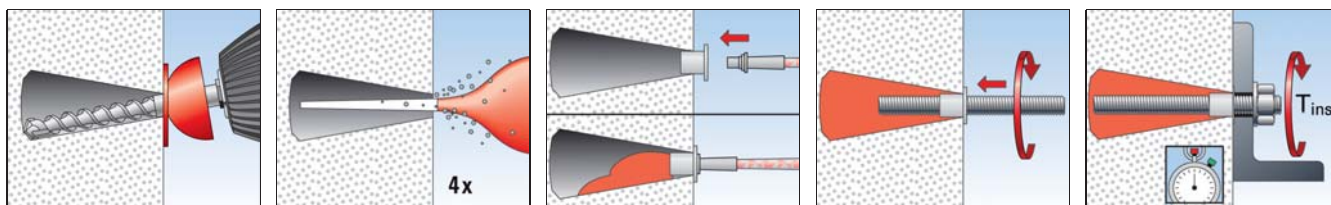

TECHNICAL DATA



Injection mortar **FIS V 300 T**



Injection mortar **FIS V 360 S**



Injection mortar **FIS V 410 C**



Static mixer **FIS MR Plus**

Item	Art.-No.	Approval			Languages on the cartridge	Scale unit	Contents	Sales unit
		DIBt	ETA	ICC				
FIS V 300 T	531573	●	■	▲	USA, RA, BR, MEX	150	1 cartridge 300 ml, 2 x FIS MR Plus	12
FIS V 360 S	094404	●	■	▲	DE, FR, NL, TR, HU, AR	180	1 cartridge 360 ml, 2 x FIS MR Plus	6
FIS V 360 S	094405	●	■	▲	EN, IT, PT, ES, ZH, JA	180	1 cartridge 360 ml, 2 x FIS MR Plus	6
FIS V 360 S	068435	●	■	▲	DA, SV, NO, FI, PL, EL	180	1 cartridge 360 ml, 2 x FIS MR Plus	6
FIS V 360 S	502283	●	■	▲	LT, LV, ET, UK, RU, KK	180	1 cartridge 360 ml, 2 x FIS MR Plus	6
FIS V 360 S	043994	●	■	▲	CS, SK, PL, HU, RO, RU	180	1 cartridge 360 ml, 2 x FIS MR Plus	6
FIS V 410 C	521431	●	■	▲	IT, EN, DE	200	1 cartridge 410 ml, 2 x FIS MR Plus	16
FIS V 410 C	534880	●	■	▲	PL, LT, LV, ET, RU	200	1 cartridge 410 ml, 2 x FIS MR Plus	12
FIS V 410 C	538131	●	■	▲	USA, RA, BR, MEX	200	1 cartridge 410 ml, 2 x FIS MR Plus	12
FIS MR Plus	545853	—	—	—	—	—	10 static mixer FIS MR Plus	10

TECHNICAL DATA



Injection mortar **FIS VW 300 T**



Injection mortar **FIS VW 360 S**



Injection mortar **FIS VW 380 C**



Static mixer **FIS MR Plus**

Item	Art.-No.	Approval		Languages on the cartridge	Scale unit	Contents	Sales unit
		DIBt	ETA				
FIS VW 300 T	507793	●	■	DE, EN, HR, SL, SR, BG	150	1 cartridge 300 ml, 2 x FIS MR Plus	12
FIS VW 300 T	507795	●	■	SV, DA, NO, CS, SK, PL, RU	150	1 cartridge 360 ml, 2 x FIS MR Plus	12
FIS VW 360 S	090753	●	■	DE, EN, FR, IT, NL, ES	180	1 cartridge 360 ml, 2 x FIS MR Plus	6
FIS VW 360 S	043997	●	■	CS, SK, PL, HU, RO, RU	180	1 cartridge 360 ml, 2 x FIS MR Plus	6
FIS VW 360 S	502284	●	■	RU, LT, LV, ET, UK, KK	180	1 cartridge 360 ml, 2 x FIS MR Plus	6
FIS VW 380 C	519328	●	■	CS, SK, PL	190	1 cartridge 380 ml, 2 x FIS MR Plus	12
FIS MR Plus	545853	—	—	—	—	10 static mixer FIS MR Plus	10

TECHNICAL DATA



Injection mortar
FIS VS 100 P



Injection mortar
FIS VS 150 C



Injection mortar
FIS VS 300 T



Injection mortar
FIS VS 360 S



Static mixer **FIS MR Plus**

Item	Art.-No.	Approval			Languages on the cartridge	Scale unit	Contents	Sales unit
		DIBt	ETA	ICC				
FIS VS 100 P	072525	●	■	▲	DE, EN, FR, IT, NL, ES	50	1 cartridge 100 ml, 2 x FIS MR Plus	6
FIS VS 150 C	045302	●	■	▲	DE, EN, FR, IT, NL, ES	70	1 cartridge 145 ml, 1 x FIS MR Plus	6
FIS VS 150 C Set	045303	●	■	▲	DE, EN, FR, IT, NL, ES	70	Set for hollow bricks: 1 cartridge 145 ml, 2 x FIS MR Plus, 6 x FIS H 16 x 85 K	6
FIS VS 300 T	093180	●	■	▲	DE, EN, FR, NL, ES, PT	150	1 cartridge 300 ml, 1 x FIS MR Plus	12
FIS VS 300 T	502285	●	■	▲	RU, LT, LV, ET, UK, KK	150	1 cartridge 300 ml, 1 x FIS MR Plus	12
FIS VS 300 T	044102	●	■	▲	CS, SK, PL, HU, RO, RU, EL	150	1 cartridge 300 ml, 1 x FIS MR Plus	12
FIS VS 300 T	093226	●	■	▲	PL, CS, DA, NO, SV, FI	150	1 cartridge 300 ml, 1 x FIS MR Plus	12
FIS VS 360 S	078664	●	■	▲	EN, ZH, ES, PT, JA	180	1 cartridge 360 ml, 2 x FIS MR Plus	6
FIS MR Plus	545853	—	—	—	—	—	10 static mixer FIS MR Plus	10



FIS V 360 S HWK small



FIS V 360 S HWK big



FIS V 360 S HWK big with dispenser FIS DM S

Item	Art.-No.	Approval			Languages on the cartridge	Contents	Sales unit
		DIBt	ETA	ICC			
FIS V 360 S HWK small	092430	●	■	▲	DE, FR, NL, TR, HU, AR	10 cartridges 360 ml, 20 x FIS MR Plus	1
FIS V 360 S HWK big	091936	●	■	▲	DE, FR, NL, TR, HU, AR	20 cartridges 360 ml, 40 x FIS MR Plus	1
FIS V 360 S HWK big	096554	●	■	▲	EN, IT, PT, ES, ZH, JA	20 cartridges 360 ml, 40 x FIS MR Plus	1
FIS V 360 S HWK big	503027	●	■	▲	CS, SK, PL, HU, RO, RU	12 cartridges 360 ml, 24 x FIS MR Plus, 1 x dispenser FIS DM S	1



FIS VS 300 T in bucket



FIS V 360 S in bucket



FIS V 410 in bucket

Item	Art.-No.	Approval			Languages on the cartridge	Contents	Sales unit
		DIBt	ETA	ICC			
FIS VS 300 T in bucket	512062	●	■	▲	DE, EN, FR, NL, ES, PT	20 cartridges 300 ml, 20 x FIS MR Plus	[pcs] 1
FIS V 360 S in bucket	503025	●	■	▲	EN, IT, PT, ES, ZH, JA	10 cartridges 360 ml, 20 x FIS MR Plus	1
FIS V 410 in bucket	531504	●	■	▲	EN, TR, RU	16 cartridge 410 ml, 32 x FIS MR Plus	1

3
Chemical fixings



FIS VS 300 T in bucket



FIS VS 300 T HWK big



FIS VS 300 T HWK small

Item	Art.-No.	Approval			Languages on the cartridge	Contents	Sales unit
		DIBt	ETA	ICC			
FIS VS 300 T in bucket	518539	●	■	▲	CS, SK, PL, HU, RO, EL	20 cartridges 300 ml, 20 x FIS MR Plus	[pcs] 1
FIS VS 300 T HWK big	517645	●	■	▲	DE, EN, FR, NL, ES, PT	20 cartridges 300 ml, 40 x FIS MR Plus	1
FIS VS 300 T HWK small	518832	●	■	▲	DE, EN, FR, NL, ES, PT	10 cartridges 300 ml, 20 x FIS MR Plus	1

CURING TIME FIS V

Cartridge temperature (mortar)	Gelling time	Temperature at anchoring base	Curing time
		- 5°C - ± 0°C	24 hrs.
+ 0°C - + 5°C	13 min.	± 0°C - + 5°C	3 hrs.
+ 5°C - +10°C	9 min.	+ 5°C - +10°C	90 min.
+10°C - +20°C	5 min.	+10°C - +20°C	60 min.
+20°C - +30°C	4 min.	+20°C - +30°C	45 min.
+30°C - +40°C	2 min.	+30°C - +40°C	35 min.

The above times apply from the moment of contact between resin and hardener in the static mixer.
For installation, the cartridge temperature must be at least +5 °C. For longer installation times, i.e. when interruptions occur in work, the mixer should be replaced.

CURING TIME FIS VW HIGH SPEED

Cartridge temperature (mortar)	Gelling time	Temperature at anchoring base	Curing time
		-15°C - -10°C ¹⁾	12 hrs.
		-10°C - - 5°C ¹⁾	8 hrs.
- 5°C - ± 0°C ¹⁾	5 min.	- 5°C - ± 0°C	3 hrs.
0°C - + 5°C	5 min.	± 0°C - + 5°C	90 min.
+ 5°C - +10°C	3 min.	+ 5°C - +10°C	45 min.
+10°C - +20°C	1 min.	+10°C - +20°C	30 min.

¹⁾ Without approval.

The above times apply from the moment of contact between resin and hardener in the static mixer.

For installation, the cartridge temperature must be at least +5 °C. For longer installation times, i.e. when interruptions occur in work, the mixer should be replaced.

CURING TIME FIS VS LOW SPEED

Cartridge temperature (mortar)	Gelling time	Temperature at anchoring base	Curing time
		± 0°C - + 5°C	6 hrs.
+ 5°C - +10°C	20 min.	+ 5°C - +10°C	3 hrs.
+10°C - +20°C	10 min.	+10°C - +20°C	2 hrs.
+20°C - +30°C	6 min.	+20°C - +30°C	60 min.
+30°C - +40°C	4 min.	+30°C - +40°C	30 min.

The above times apply from the moment of contact between resin and hardener in the static mixer.

For installation, the cartridge temperature must be at least +5 °C. For longer installation times, i.e. when interruptions occur in work, the mixer should be replaced.

LOADS

Injection system FIS V: Injection mortar FIS V with Threaded rod FIS A ¹⁾

zinc plated steel / stainless steel / high corrosion resistant steel

Permissible loads of a single anchor in cracked normal concrete (concrete tension zone) of strength class C20/25 (~B25) ²⁾³⁾⁴⁾⁵⁾¹¹⁾										Minimum spacings while reducing the load	
Type	Material fixing element	Min. member thickness h_{min} [mm]	Effective anchorage depth h_{ef} ⁶⁾ [mm]	Maximum torque moment T_{max} [Nm]	Permissible tensile load N_{perm} ⁷⁾ [kN]	Permissible shear load V_{perm} ⁷⁾ [kN]	Required edge distance (with one edge) for		Required spacing for s_{cr} [mm]	Min. spacing s_{min} ⁸⁾⁹⁾ [mm]	Min. edge distance c_{min} ⁸⁾⁹⁾ [mm]
							Max. tension load c [mm]	Max. shear load c [mm]			
FIS A M 10	5.8	100	60	20	5,4	8,6	90	185	180	45	45
		120	90		8,1		125	155			
		230	200		13,8		85	110			
	8.8	100	60		5,4	10,8	90	235	180		
		120	90		8,1	13,3	125	255	270		
		230	200		18,0			150	600		
	A4-70	100	60		5,4	9,3	90	200	180		
		120	90		8,1		125	170	270		
		230	200		15,5		100	115	600		
	C-70	100	60		5,4	10,8	90	235	180		
		120	90		8,1	11,6	125	220	270		
		230	200		18,0			140	600		
FIS A M 12	5.8	100	70	40	7,5	12,0	105	255	210	55	55
		140	110		11,8		145	195			
		270	240		20,5		110	135			
	8.8	100	70		7,5	15,1	105	330	210		
		140	110		11,8	19,3	145	340	330		
		270	240		25,9			200	720		
	A4-70	100	70		7,5	13,5	105	290	210		
		140	110		11,8		145	225	330		
		270	240		22,5		125	145	720		
	C-70	100	70		7,5	15,1	105	330	210		
		140	110		11,8	16,9	145	290	330		
		270	240		25,9			175	720		

LOADS

Injection system FIS V: Injection mortar FIS V with Threaded rod FIS A ¹⁾

zinc plated steel / stainless steel / high corrosion resistant steel

Permissible loads of a single anchor in cracked normal concrete (concrete tension zone) of strength class C20/25 (~B25) ^{2) 3) 4) 5) 11)}										Minimum spacings while reducing the load	
Type	Material fixing element	Min. member thickness	Effective anchorage depth	Maximum torque moment	Permissible tensile load	Permissible shear load	Required edge distance (with one edge) for		Required spacing for	Min. spacing	Min. edge distance
		h_{min} [mm]	$h_{ef}^{6)}$ [mm]	T_{max} [Nm]	$N_{perm}^{7)}$ [kN]	$V_{perm}^{7)}$ [kN]	Max. tension load c [mm]	Max. shear load c [mm]	Max. Load s_{cr} [mm]	$s_{min}^{8) 9)}$ [mm]	$c_{min}^{8) 9)}$ [mm]
FIS A M 16	5.8	120	80	60	11,5	22,3	120	445	240	65	65
		170	125		18,0		185	350	375		
		360	320		37,6		145	195	960		
	8.8	120	80		11,5	23,0	120	460	240		
		170	125		18,0	35,9	185	600	375		
		360	320		46,0		320	960			
	A4-70	120	80		11,5	23,0	120	460	240		
		170	125		18,0	25,2	185	400	375		
		360	320		42,0		165	215	960		
	C-70	120	80		11,5	23,0	120	460	240		
		170	125		18,0	31,4	185	515	375		
		360	320		46,0		270	960			
FIS A M 20	5.8	140	90	120	14,6	29,3	135	530	270	85	85
		220	170		28,0	34,9	225	455	510		
		450	400		58,6		195	260	1200		
	8.8	140	90		14,6	29,3	135	530	270		
		220	170		28,0	56,0	225	780	510		
		450	400		65,8		435	1200			
	A4-70	140	90		14,6	29,3	135	530	270		
		220	170		28,0	39,3	225	520	510		
		450	400		65,5		285	1200			
	C-70	140	90		14,6	29,3	135	530	270		
		220	170		28,0	49,0	225	670	510		
		450	400		65,8		370	1200			
FIS A M 24	5.8	160	96	150	15,5	31,0	145	520	290	105	105
		270	210		33,9	50,9	265	590	630		
		540	480		77,6		330	1440			
	8.8	160	96		15,5	31,0	145	520	290		
		270	210		33,9	67,9	265	825	630		
		540	480		77,6		80,7	570	1440		
	A4-70	160	96		15,5	31,0	145	520	290		
		270	210		33,9	56,6	265	670	630		
		540	480		77,6		360	1440			
	C-70	160	96		15,5	31,0	145	520	290		
		270	210		33,9	67,9	265	825	630		
		540	480		77,6		70,6	480	1440		
FIS A M 27	5.8	170	108	200	17,4	34,9	165	545	325	125	125
		310	250		40,4	65,7	290	695	750		
		600	540		87,2		390	1620			
	8.8	170	108		17,4	34,9	165	545	325		
		310	250		40,4	80,8	290	885	750		
		600	540		87,2		104,9	700	1620		
	A4-70	170	108		17,4	34,9	165	545	325		
		310	250		40,4	73,6	290	795	750		
		600	540		87,2		440	1620			
	C-70	170	108		17,4	34,9	165	545	325		
		310	250		40,4	80,8	290	885	750		
		600	540		87,2		91,8	590	1620		

LOADS

Injection system FIS V: Injection mortar FIS V with Threaded rod FIS A ¹⁾

zinc plated steel / stainless steel / high corrosion resistant steel

Permissible loads of a single anchor in cracked normal concrete (concrete tension zone) of strength class C20/25 (~B25) ^{2) 3) 4) 5) 11)}										Minimum spacings while reducing the load	
Type	Material fixing element	Min. member thickness h_{min} [mm]	Effective anchorage depth $h_{ef}^{6)}$ [mm]	Maximum torque moment T_{max} [Nm]	Permissible tensile load $N_{perm}^{7)}$ [kN]	Permissible shear load $V_{perm}^{7)}$ [kN]	Required edge distance (with one edge) for		Required spacing for Max. Load s_{cr} [mm]	Min. spacing $s_{min}^{8) 9)}$ [mm]	Min. edge distance $c_{min}^{8) 9)}$ [mm]
							Max. tension load c [mm]	Max. shear load c [mm]			
FIS A M 30	5.8	190	120	300	21,5	43,1	180	630	360	140	140
		350	280		50,3	80,6	320	795	840		
		670	600		107,7			440	1800		
	8.8	190	120		21,5	43,1	180	630	360		
		350	280		50,3	100,5	320	1035	840		
		670	600		107,7	128,2		805	1800		
	A4-70	190	120		21,5	43,1	180	630	360		
		350	280		50,3	89,9	320	905	840		
		670	600		107,7			505	1800		
	C-70	190	120		21,5	43,1	180	630	360		
		350	280		50,3	100,5	320	1035	840		
		670	600		107,7	112,2		675	1800		

For the design the complete assessment ETA-02/0024 has to be considered. ¹⁰⁾

¹⁾ Also valid for threaded rod RG M in the same property class.

²⁾ The partial safety factors for material resistance as regulated in the ETA-02/0024 as well as a partial safety factor for load actions of $\gamma_L = 1,4$ are considered. As an single anchor counts e.g. an anchor with a spacing $s \geq 3 \cdot h_{ef}$ and an edge distance $c \geq 1,5 \cdot h_{ef}$. Accurate data see ETA-02/0024.

³⁾ The given loads are valid for injection mortar FIS V for fixations in dry and humid concrete for temperatures in the substrate up to 50 °C (resp. short term up to 80 °C. For drill hole cleaning see ETA-02/0024.

⁴⁾ For higher concrete strength classes up to C50/60 higher permissible loads may be possible.

⁵⁾ Drill method hammer drilling. For further allowable application conditions see ETA-02/0024.

⁶⁾ For the sizes M10 - M30 the min. anchorage depth and the max. anchorage depth are given. The anchorage depth can be chosen freely between these borders.

⁷⁾ For combinations of tensile loads, shear loads, bending moments as well as reduced edge distances or spacings (anchor groups) see ETA-02/0024.

⁸⁾ Minimum possible axial spacings resp. edge distance while reducing the permissible load.

⁹⁾ Minimum possible spacing resp. edge distance while reducing the permissible load for the required minimum member thickness. The combination of minimum edge distance and minimum spacing is not possible. One of both values has to be increased acc. ETA-02/0024.

¹⁰⁾ The given loads refer to the European Technical Assessment ETA-02/0024, issue date 13/02/2017. Design of the loads according ETAG 001, Technical Report TR 029 (for static resp. quasi-static loads).

¹¹⁾ A reinforcement in the concrete to prevent splitting is required. The width of the cracks has to be limited under consideration of the splitting forces at $w_k \sim 0,3$ mm.

LOADS

Injection system FIS V: Injection mortar FIS V with Threaded rod FIS A ¹⁾

zinc plated steel / stainless steel / high corrosion resistant steel

Permissible loads of a single anchor in non-cracked normal concrete (concrete compression zone) of strength class C20/25 (~B25) ²⁾³⁾⁴⁾⁵⁾										Minimum spacings while reducing the load					
Type	Material fixing element	Min. member thickness	Effective anchorage depth	Maximum torque moment	Permissible tensile load	Permissible shear load	Required edge distance (with one edge) for		Required spacing for	Min. spacing	Min. edge distance				
							Max. tension load c	Max. shear load c				Max. Load s _{cr}	s _{min} ⁸⁾⁹⁾	c _{min} ⁸⁾⁹⁾	
		h _{min} [mm]	h _{ef} ⁶⁾ [mm]	T _{max} [Nm]	N _{perm} ⁷⁾ [kN]	V _{perm} ⁷⁾ [kN]	[mm]	[mm]	[mm]	[mm]	[mm]				
FIS A M 6	5.8	100	50	5	4,0	2,9	65	50	150	40	40				
			60		4,8				180						
			72		4,0				220						
	8.8	100	50		4,0	4,6	65	70	150						
			60		4,8				180						
			72		5,8				220						
	A4-70	100	50		4,0	3,2	60	55	150						
			60		4,8				180						
			72		5,4				220						
	FIS A M 8	5.8	100		60	10	7,9	5,1	90			180	40	40	
					80		9,0		80			70			240
					160		9,0		40			60			480
8.8		100	60	7,9	8,4		90	125	180						
			80	10,5			100	115	240						
			160	13,9			55	90	480						
A4-70		100	60	7,9	5,9		90	85	180						
			80	9,8			75	240							
			160	40			70	480							
C-70		100	60	7,9	7,3		90	105	180						
			80	10,5			100	95	240						
			160	12,2			40	80	480						
FIS A M 10		5.8	100	60	20		9,9	8,6	90	125	180	45			45
				90			13,8		115	105	270				
				200			9,9		45	85	600				
		8.8	100	60			9,9	13,3	90	200	180				
				90			14,8		125	170	270				
				200			22,1		70	115	600				
	A4-70	100	60	9,9		9,3	90	135	180						
			90	14,8			125	115	270						
			200	15,5			45	90	600						
	C-70	100	60	9,9		11,6	90	175	180						
			90	14,8			125	150	270						
			200	19,3			55	105	600						
	FIS A M 12	5.8	100	70		40	13,8	12,0	140	175	210		55	55	
				110			20,5		165	130	330				
				240			55		100	720					
		8.8	100	70			13,8	19,3	140	295	210				
				110			21,7		180	230	330				
				240			32,1		85	150	720				
A4-70		100	70	13,8	13,5		140	200	210						
			110	21,7			180	150	330						
			240	22,5			55	110	720						
C-70		100	70	13,8	16,9		140	255	210						
			110	21,7			180	195	330						
			240	28,1			65	135	720						

LOADS

Injection system FIS V: Injection mortar FIS V with Threaded rod FIS A ¹⁾

zinc plated steel / stainless steel / high corrosion resistant steel

Permissible loads of a single anchor in non-cracked normal concrete (concrete compression zone) of strength class C20/25 (~B25) ²⁾³⁾⁴⁾⁵⁾										Minimum spacings while reducing the load		
Type	Material fixing element	Min. member thickness	Effective anchorage depth	Maximum torque moment	Permissible tensile load	Permissible shear load	Required edge distance (with one edge) for		Required spacing for	Min. spacing	Min. edge distance	
							Max. tension load c	Max. shear load c				Max. Load s _{cr}
		h _{min} [mm]	h _{ef} ⁶⁾ [mm]	T _{max} [Nm]	N _{perm} ⁷⁾ [kN]	V _{perm} ⁷⁾ [kN]	[mm]	[mm]	[mm]	[mm]	[mm]	
FIS A M 16	5.8	120	80	60	17,2	22,3	160	305	240	65	65	
		170	125		29,9		245	235	375			
		360	320		37,6		65	150	960			
	8.8	120	80		17,2	34,4	160	495	240			
		170	125		29,9	35,9	245	405	375			
		360	320		59,8	135	220	960				
	A4-70	120	80		17,2	25,2	160	350	240			
		170	125		29,9		245	270	375			
		360	320		42,0		70	165	960			
	C-70	120	80		17,2	31,4	160	445	240			
		170	125		29,9		245	350	375			
		360	320		52,3		105	195	960			
FIS A M 20	5.8	140	90	120	20,5	34,9	170	435	270	85	85	
		220	170		48,3		340	300	510			
		450	400		58,6		85	195	1200			
	8.8	140	90		20,5	41,1	170	525	270			
		220	170		48,3	56,0	340	510				
		450	400		93,3	230	290	1200				
	A4-70	140	90		20,5	39,3	170	500	270			
		220	170		48,3		340	345	510			
		450	400		65,5		95	215	1200			
	C-70	140	90		20,5	41,1	170	525	270			
		220	170		48,3	49,0	340	450	510			
		450	400		81,7	140	260	1200				
FIS A M 24	5.8	160	96	150	22,6	45,2	170	540	290	105	105	
		270	210		67,9		435	390	630			
		540	480		84,3		105	250	1440			
	8.8	160	96		22,6	45,2	170	540	290			
		270	210		67,9	80,7	435	675	630			
		540	480		134,5	360	365	1440				
	A4-70	160	96		22,6	45,2	170	540	290			
		270	210		67,9	56,6	435	445	630			
		540	480		94,4	120	270	1440				
	C-70	160	96		22,6	45,2	170	540	290			
		270	210		67,9	70,6	435	580	630			
		540	480		117,7	235	325	1440				
FIS A M 27	5.8	170	108	200	27,0	54,0	195	605	325	125	125	
		310	250		85,8		65,7	495	460			750
		600	540		109,5		125	295	1620			
	8.8	170	108		27,0	54,0	195	605	325			
		310	250		85,8	104,9	495	805	750			
		600	540		174,9	500	450	1620				
	A4-70	170	108		27,0	54,0	195	605	325			
		310	250		85,8	73,6	495	530	750			
		600	540		122,7	155	320	1620				
	C-70	170	108		27,0	54,0	195	605	325			
		310	250		85,8	91,8	495	690	750			
		600	540		153,0	355	385	1620				

Chemical fixings 3

LOADS

Injection system FIS V: Injection mortar FIS V with Threaded rod FIS A ¹⁾

zinc plated steel / stainless steel / high corrosion resistant steel

Permissible loads of a single anchor in non-cracked normal concrete (concrete compression zone) of strength class C20/25 (~B25) ²⁾³⁾⁴⁾⁵⁾										Minimum spacings while reducing the load	
Type	Material fixing element	Min. member thickness	Effective anchorage depth	Maximum torque moment	Permissible tensile load	Permissible shear load	Required edge distance (with one edge) for		Required spacing for	Min. spacing	Min. edge distance
							Max. tension load c	Max. shear load c			
		h _{min} [mm]	h _{ef} ⁶⁾ [mm]	T _{max} [Nm]	N _{perm} ⁷⁾ [kN]	V _{perm} ⁷⁾ [kN]	[mm]	[mm]	[mm]	[mm]	[mm]
FIS A M 30	5.8	190	120	300	31,6	63,2	210	660	360	140	140
		350	280		106,8	80,6	595	525	840		
		670	600		133,8		140	330	1800		
	8.8	190	120		31,6	63,2	210	660	360		
		350	280		106,8	128,2	595	920	840		
		670	600		213,7		610	515	1800		
	A4-70	190	120		31,6	63,2	210	660	360		
		350	280		106,8	89,9	595	600	840		
		670	600		150,0		195	365	1800		
	C-70	190	120		31,6	63,2	210	660	360		
		350	280		106,8	112,2	595	785	840		
		670	600		187,0		445	435	1800		

For the design the complete assessment ETA-02/0024 has to be considered. ¹⁰⁾

¹⁾ Also valid for threaded rod RG M in the same property class.

²⁾ The partial safety factors for material resistance as regulated in the ETA-02/0024 as well as a partial safety factor for load actions of $\gamma_L = 1,4$ are considered. As an single anchor counts e.g. an anchor with a spacing $s \geq 3 \cdot h_{ef}$ and an edge distance $c \geq 1,5 \cdot h_{ef}$. Accurate data see ETA-02/0024.

³⁾ The given loads are valid for injection mortar FIS V for fixations in dry and humid concrete for temperatures in the substrate up to 50 °C (resp. short term up to 80 °C. For drill hole cleaning see ETA-02/0024.

⁴⁾ For higher concrete strength classes up to C50/60 higher permissible loads may be possible.

⁵⁾ Drill method hammer drilling. For further allowable application conditions see ETA-02/0024.

⁶⁾ For the sizes M6 - M30 the min. anchorage depth and the max. anchorage depth are given. The anchorage depth can be chosen freely between these borders.

⁷⁾ For combinations of tensile loads, shear loads, bending moments as well as reduced edge distances or spacings (anchor groups) see ETA-02/0024.

⁸⁾ Minimum possible axial spacings resp. edge distance while reducing the permissible load.

⁹⁾ Minimum possible spacing resp. edge distance while reducing the permissible load for the required minimum member thickness. The combination of minimum edge distance and minimum spacing is not possible. One of both values has to be increased acc. ETA-02/0024.

¹⁰⁾ The given loads refer to the European Technical Assessment ETA-02/0024, issue date 13/02/2017. Design of the loads according ETAG 001, Technical Report TR 029 (for static resp. quasi-static loads).

LOADS

Injection system FIS V: Injection mortar FIS V with Internal threaded anchor RG M I

zinc plated steel / stainless steel

Permissible loads of a single anchor in non-cracked normal concrete (concrete compression zone) of strength class C20/25 (~B25) ^{1) 2) 3)}										Minimum spacings while reducing the load	
Type	Screw material resp. screw surface	Min. member thickness h_{min} [mm]	Effective anchorage depth h_{ef} [mm]	Maximum torque moment T_{max} [Nm]	Permissible tensile load $N_{perm}^{4)}$ [kN]	Permissible shear load $V_{perm}^{4)}$ [kN]	Required edge distance (with one edge) for		Required spacing for Max. Load s_{cr} [mm]	Min. spacing $s_{min}^{5) 6)}$ [mm]	Min. edge distance $c_{min}^{5) 6)}$ [mm]
							Max. tension load c [mm]	Max. shear load c [mm]			
RG M 8 I	5.8	120	90	10	9,0	5,3	70	65	270	55	55
	8.8						130	95			
	A4-70						80	70			
RG M 10 I	5.8	130	90	20	13,8	8,3	105	90	270	65	65
	8.8						175	155			
	A4-70						130	100			
RG M 12 I	5.8	170	125	40	20,5	12,1	155	110	375	75	75
	8.8						190	190			
	A4-70						175	125			
RG M 16 I	5.8	210	160	80	35,7	22,4	240	180	480	95	95
	8.8							320			
	A4-70							205			
RG M 20 I	5.8	270	200	120	54,8	35,4	335	245	600	125	125
	8.8							315			
	A4-70							285			

For the design the complete assessment ETA-02/0024 has to be considered. ⁷⁾

¹⁾ The partial safety factors for material resistance as regulated in the ETA-02/0024 as well as a partial safety factor for load actions of $\gamma_L = 1,4$ are considered. As an single anchor counts e.g. an anchor with a spacing $s \geq 3 \cdot h_{ef}$ and an edge distance $c \geq 1,5 \cdot h_{ef}$. Accurate data see ETA-02/0024.

²⁾ For higher concrete strength classes up to C50/60 higher permissible loads may be possible.

³⁾ Drill method hammer drilling. For further allowable application conditions see ETA-02/0024.

⁴⁾ For combinations of tensile loads, shear loads, bending moments as well as reduced edge distances or spacings (anchor groups) see ETA-02/0024.

⁵⁾ Minimum possible axial spacings resp. edge distance while reducing the permissible load.

⁶⁾ Minimum possible spacing resp. edge distance while reducing the permissible load for the required minimum member thickness. The combination of minimum edge distance and minimum spacing is not possible. One of both values has to be increased acc. ETA-02/0024.

⁷⁾ The given loads refer to the European Technical Assessment ETA-02/0024, issue date 13/02/2017. Design of the loads according ETAG 001, Technical Report TR 029 (for static resp. quasi-static loads).

LOADS

Injection system FIS V with threaded rod FIS A ⁴⁾

Highest permissible loads^{1) 5)} for a single anchor in solid brick masonry (without injection anchor sleeve) for pre-positioned or push-through installation.

For the design the complete assessment ETA-10/0383 has to be considered.

Type	Compressive brick strength f_b [N/mm ²]	Brick raw density ρ [kg/dm ³]	Minimum brick dimensions ⁶⁾ (L x W x H) [mm]	Min. effective anchorage depth h_{ef} [mm]	Min. member thickness h_{min} [mm]	Maximum torque $T_{inst,max}$ [Nm]	Permissible tensile load ³⁾ N_{perm} [kN]	Permissible shear load ³⁾ V_{perm} [kN]	Characteristic spacing parallel to bed joint $s_{cr \parallel}$ [mm]	Characteristic spacing perpendicular to bed joint $s_{cr \perp}$ [mm]	Min. spacing ²⁾ $s_{min \parallel} / s_{min \perp}$ [mm]	Characteristic resp. min. edge distance ²⁾ $c_{cr} = c_{min}$ [mm]																		
Solid brick Mz, NF acc. to EN 771-1																														
M6	≥ 10	≥ 1,8	240x115x71 (NF)	50	115	4	1,14	0,71	240	75	240 / 75	100																		
M8				50		10	1,14	0,71				100																		
M10				50		10	1,00	1,14				100																		
M10				80		10	1,43	1,14				100																		
M10				200		10	3,42	2,43				150																		
M12				50		10	0,86	1,14				100																		
M12				80		10	1,57	1,14				100																		
M12				200		10	2,29	3,29				150																		
M6				≥ 20		≥ 1,8	240x115x71 (NF)	50				4	1,57	1,14	100															
M8								10				1,57	1,14	100																
M10								10				1,43	1,71	100																
M10								80				10	2,00	1,71	100															
M10								200				10	3,42	3,43	150															
M12								50				10	1,29	1,57	100															
M12								80				10	2,29	1,57	100															
M12								200				10	3,29	3,43	150															
Solid brick Mz, 2DF acc. to EN 771-1																														
M6	≥ 10	≥ 1,8	240x115x113 (2DF)	50	115	4	0,86	0,71	240	115	120 / 115	60																		
M8				50		10	0,86	0,86																						
M10				100		10	1,29	1,00																						
M12				100		10	1,57	1,00																						
M16	100			10		1,57	0,86																							
M6	≥ 16			≥ 1,8		240x115x113 (2DF)	50	4					1,29	1,14	100															
M8							10	1,29					1,43	100																
M10							100	10					2,14	1,57	100															
M12							100	10					2,29	1,57	100															
M16							100	10					2,29	1,43	100															
Solid sand-lime brick KS acc. to EN 771																														
M6							≥ 10	≥ 2,0					250x240x240	50	240	4	1,43	0,71	250	240	80 / 80	60								
M8																10	2,00	1,29												
M10	10			2,00		1,29																								
M12	10			2,00		1,29																								
M16	10			1,57		1,29																								
M6	≥ 20	≥ 2,0	250x240x240	50	240	4			2,14	1,14	250	240				80 / 80	60													
M8						10			2,57	1,86																				
M10						10			2,57	1,86																				
M12						10			2,57	1,86																				
M16						10			2,14	1,86																				
M6						≥ 28			≥ 2,0	250x240x240								50					240	4	2,43	1,43	250	240	80 / 80	60
M8																								10	2,57	2,57				
M10																								10	2,57	2,57				
M12	10	2,57	2,57																											
M16	10	2,57	2,57																											

¹⁾ The required partial safety factors for material resistance as well as a partial safety factor for load actions of $\gamma_L = 1,4$ are considered.

²⁾ Minimum feasible spacings resp. edge distance. Details as well as to the distances to joints see assessment.

³⁾ For combinations of tensile loads, shear loads, bending moments as well as reduced edge distances or spacings (anchor groups) see assessment.

⁴⁾ Zinc-plated, stainless steel A4 and high corrosion-resistant steel C.

⁵⁾ The given loads are valid for installation and use of fixations in dry masonry - use category d/d - for temperatures in the substrate up to +50 °C (resp. short term up to 80 °C) and drill hole cleaning according to assessment. The given brick types in combination with the permissible loads are an extract of the assessment.

⁶⁾ Hole patterns see assessment.

LOADS

Injection system FIS V with threaded rod FIS A⁵⁾ and anchor sleeve FIS H..K

Highest permissible loads¹⁾⁶⁾ for a single anchor in solid brick masonry (with injection anchor sleeve) for pre-positioned installation. For the design the complete assessment ETA-10/0383 has to be considered.

Type of anchor sleeve with threaded rod	Compressive brick-strength f_b [N/mm ²]	Brick raw density ρ [kg/dm ³]	Minimum brick dimensions ⁹⁾ (L x W x H) [mm]	Min. effective anchorage depth ⁴⁾ h_{ef} [mm]	Min. member thickness h_{min} [mm]	Maximum torque $T_{inst,max}$ [Nm]	Permissible tensile load ³⁾ N_{perm} [kN]	Permissible shear load ³⁾ V_{perm} [kN]	Characteristic spacing parallel to bed joint $s_{cr \parallel}$ [mm]	Characteristic spacing perpendicular to bed joint $s_{cr \perp}$ [mm]	Min. spacing ²⁾ $s_{min \parallel} / s_{min \perp}$ [mm]	Characteristic resp. min. edge distance ²⁾ $c_{cr} = c_{min}$ [mm]
Solid brick Mz, 2DF acc. to EN 771-1												
16x85 M8	≥ 10	≥ 1,8	240x115x113 (2DF)	85	115	10	0,86	0,86	240	115	120 / 115	60
16x85 M10							0,86	1,00				
16x85 M8	≥ 16						1,29	1,43				
16x85 M10							1,29	1,57				
Solid sand-lime brick KS acc. to EN 771												
16x85 M8/M10	≥ 10	≥ 2,0	250x240x240	85	240	10	2,29	1,29	250	240	80 / 80	60
16x85 M8/M10	≥ 20						2,57	1,86				
16x85 M8/M10	≥ 28						2,57	2,57				
Lightweight concrete block Vbl acc. to EN 771-3												
12x85 M6	≥ 4	≥ 1,6	250x240x239	85	240	4	1,00	0,57	250	250	250 / 250	130
12x50 M8				50			0,57	0,86				
12x85 M8				85			1,00	0,86				
16x85 M10				85			1,14	1,00				
20x85 M12				85			1,43	1,29				
12x85 M6	≥ 6			85			1,43	0,86				
12x50 M8				50			0,86	1,29				
12x85 M8				85			1,43	1,29				
16x85 M8 / M10				85			1,86	1,57				
20x85 M12 / M16				85			2,14	1,86				
12x85 M6	≥ 8			85			2,00	1,14				
12x50 M8				50			1,14	1,71				
12x85 M8				85			2,00	1,71				
16x85 M8 / M10				85			2,43	2,00				
20x85 M12 / M16				85			2,57	2,43				

¹⁾ The required partial safety factors for material resistance as well as a partial safety factor for load actions of $\gamma_L = 1,4$ are considered.

²⁾ Minimum feasible spacings resp. edge distance. Details as well as to the distances to joints see assessment.

³⁾ For combinations of tensile loads, shear loads, bending moments as well as reduced edge distances or spacings (anchor groups) see assessment.

⁴⁾ The maximum anchorage depth is corresponding with the relevant anchor sleeves FIS H..K (see technical data).

⁵⁾ Zinc-plated, stainless steel A4 and high corrosion-resistant steel C.

⁶⁾ The given loads are valid for installation and use of fixations in dry masonry - use category d/d - for temperatures in the substrate up to +50 °C (resp. short term up to 80 °C) and drill hole cleaning according to assessment. The given brick types in combination with the permissible loads are an extract of the assessment.

⁷⁾ Hole patterns see assessment.

LOADS

Injection system FIS V with threaded rod FIS A⁵⁾ and anchor sleeve FIS H..K

Highest permissible loads^{1) 6)} for a single anchor in perforated brick masonry (with injection anchor sleeve) for pre-positioned installation. For the design the complete assessment ETA-10/0383 has to be considered.

Type of anchor sleeve with threaded rod	Compressive brick-strength f_b [N/mm ²]	Brick raw density ρ [kg/dm ³]	Minimum brick-dimensions ⁷⁾ (L x W x H) [mm]	Min. effective anchorage depth ⁴⁾ h_{ef} [mm]	Min. member thickness h_{min} [mm]	Maximum torque $T_{inst,max}$ [Nm]	Permissible tensile load ³⁾ N_{perm} [kN]	Permissible shear load ³⁾ V_{perm} [kN]	Characteristic spacing parallel to bed joint $s_{cr \parallel}$ [mm]	Characteristic spacing perpendicular to bed joint $s_{cr \perp}$ [mm]	Min. spacing ²⁾ $s_{min \parallel} / s_{min \perp}$ [mm]	Characteristic resp. min. edge distance ²⁾ $c_{cr} = c_{min}$ [mm]								
Vertically perforated brick Hlz, shape B acc. to EN 771-1																				
12x50 M6/M8	≥ 4	≥ 1,0	500x175x237 or 370x240x237	50	175	2,0	0,11	0,14	500 resp. 370	240	100 / 100	100								
16x85 M8/M10	≥ 4			85			0,26	0,14												
20x130 M12/M16	≥ 4			130			0,34	0,17												
12x50 M6/M8	≥ 8			50			0,21	0,26												
16x85 M8/M10	≥ 8			85			0,57	0,26												
20x130 M12/M16	≥ 8			130			0,71	0,34												
12x50 M6/M8	≥ 12			50			0,34	0,43												
16x85 M8/M10	≥ 12			85			0,86	0,43												
20x130 M12/M16	≥ 12			130			1,14	0,57												
Vertically perforated brick Hlz, acc. to EN 771-1																				
12x50 M6	≥ 6	≥ 1,4	240x115x113 (2DF)	50	115	2,0	0,21	0,34	240	115	240 / 115	80								
12x85 M8	≥ 6			85			0,34	0,57												
16x85 M8/M10	≥ 6			85			0,21	0,43												
20x85 M12/M16	≥ 6			85			0,26	0,71												
12x50 M6	≥ 16			50			0,57	0,86												
12x85 M8	≥ 16			85			0,86	1,57												
16x85 M8/M10	≥ 16			85			0,57	1,00												
20x85 M12/M16	≥ 16			85			0,71	1,57												
12x50 M6	≥ 28			50			1,00	1,43												
12x85 M8	≥ 28			85			1,57	1,57												
16x85 M8/M10	≥ 28			85			1,00	1,57												
20x85 M12/M16	≥ 28			85			1,29	1,57												
Perforated sand-lime brick KSL acc. to EN 771-2																				
12x50 M6/M8	≥ 12			≥ 1,4			240x175x113	50					175	2,0	0,71	0,71	240	115	100 / 115	60
16x85 M8/M10	≥ 12	85	0,86		1,29	80														
20x85 M12	≥ 12	85	1,00		1,29	60														
12x50 M6/M8	≥ 20	50	1,29		1,14	80														
16x85 M8/M10	≥ 20	85	1,43		2,14															
20x85 M12	≥ 20	85	1,71		2,14															
Lightweight concrete hollow block Hbl acc. to EN 771-3																				
12x50 M6/M8	≥ 2	≥ 1,0	362x240x240	50	240	2,0	0,34	0,26	362	240	100 / 240	60								
16x85 M8/M10	≥ 2			85			0,43	0,26												
20x200 M12/M16	≥ 2			180			0,71	0,26												
12x50 M6/M8	≥ 4			50			0,71	0,57												
16x85 M8/M10	≥ 4			85			0,86	0,57												
20x200 M12/M16	≥ 4			180			1,57	0,57												

¹⁾ The required partial safety factors for material resistance as well as a partial safety factor for load actions of $\gamma_L = 1,4$ are considered.

²⁾ Minimum feasible spacings resp. edge distance. Details as well as to the distances to joints see assessment.

³⁾ For combinations of tensile loads, shear loads, bending moments as well as reduced edge distances or spacings (anchor groups) see assessment.

⁴⁾ The maximum anchorage depth is corresponding with the relevant anchor sleeves FIS H..K (see technical data).

⁵⁾ Zinc-plated, stainless steel A4 and high corrosion-resistant steel C.

⁶⁾ The given loads are valid for installation and use of fixations in dry masonry - use category d/d - for temperatures in the substrate up to +50 °C (resp. short term up to 80 °C) and drill hole cleaning according to assessment. The given brick types in combination with the permissible loads are an extract of the assessment.

⁷⁾ Hole patterns see assessment.

LOADS

Injection system FIS V with threaded rod FIS A⁴⁾

Highest permissible loads¹⁾⁵⁾ for a single anchor in aerated concrete.

For the design the complete assessment ETA-10/0383 has to be considered.

Type threaded rod	Compressive brick strength f_b [N/mm ²]	Brick raw density ρ [kg/dm ³]	Minimum brick dimensions (L x W x H) [mm]	Min. effective anchorage depth h_{ef} [mm]	Min. member thickness h_{min} [mm]	Maximum torque $T_{inst,max}$ [Nm]	Permissible tensile load ⁹⁾ N_{perm} [kN]	Permissible shear load ³⁾ V_{perm} [kN]	Characteristic spacing parallel to bed joint $s_{cr \parallel}$ [mm]	Characteristic spacing perpendicular to bed joint $s_{cr \perp}$ [mm]	Min. spacing ²⁾ $s_{min \parallel} / s_{min \perp}$ [mm]	Characteristic resp. min. edge distance ²⁾ $c_{cr} = c_{min}$ [mm]																	
Aerated concrete acc. to EN 771-4																													
M8 ⁶⁾	≥ 2	≥ 0,35		100	130		1	0,54	0,43	250	250	250	100																
M10 ⁶⁾							2	0,54	0,43																				
M12 ⁶⁾							2	0,71	0,54																				
M16 ⁶⁾	2	0,71					0,43																						
M8 ⁶⁾	≥ 4	≥ 0,50						100	130						1	0,71	0,89	250	250	250	100								
M10 ⁶⁾															2	1,07	0,71												
M12 ⁶⁾															2	0,89	0,89												
M16 ⁶⁾															2	0,71	0,71												
M8 ⁶⁾	≥ 6	≥ 0,65														100	130						1	1,25	1,07	250	250	250	100
M10 ⁶⁾																							2	1,79	1,07				
M12 ⁶⁾																							2	1,79	1,25				
M16 ⁶⁾																							2	1,07	1,61				
M8, M10, M12 ⁷⁾	≥ 2	≥ 0,35		75	105	2				0,71	0,89	240	240										240	120					
M8, M10, M12 ⁷⁾	≥ 4	≥ 0,50								1,07	1,61																		
M8, M10, M12 ⁷⁾	≥ 6	≥ 0,65								1,43	2,14																		
M8, M10, M12 ⁷⁾	≥ 2	≥ 0,35								0,89	0,89																		
M8, M10, M12 ⁷⁾	≥ 4	≥ 0,50					1,25	1,61																					
M8, M10, M12 ⁷⁾	≥ 6	≥ 0,65					1,61	2,14																					
M8, M10, M12 ⁷⁾	≥ 2	≥ 0,35						95	125	2	0,89			0,89				300	250	300 / 250	150								
M8, M10, M12 ⁷⁾	≥ 4	≥ 0,50									1,25			1,61															
M8, M10, M12 ⁷⁾	≥ 6	≥ 0,65									1,61			2,14															

¹⁾ The required partial safety factors for material resistance as well as a partial safety factor for load actions of $\gamma_L = 1,4$ are considered.

²⁾ Minimum feasible spacings resp. edge distance. Details as well as to the distances to joints see assessment.

³⁾ For combinations of tensile loads, shear loads, bending moments as well as reduced edge distances or spacings (anchor groups) see assessment.

⁴⁾ Zinc-plated, stainless steel A4 and high corrosion-resistant steel C.

⁵⁾ The given loads are valid for installation and use of fixations in dry masonry - use category d/d - for temperatures in the substrate up to +50 °C (resp. short term up to 80 °C) and drill hole cleaning according to assessment. The given brick types in combination with the permissible loads are an extract of the assessment.

⁶⁾ Cylindrical drill hole. Pre-positioned and push-through installation possible.

⁷⁾ Drill hole to be made with cone drill bit PBB. Pre-positioned installation only.

The solid injection mortar for standard applications in cracked concrete and masonry



High-bay warehouses



Air conditioning units

BUILDING MATERIALS

Approved for anchorings in:

- Concrete C20/25 to C50/60, cracked
- Hollow blocks made from lightweight concrete
- Vertically perforated brick
- Perforated sand-lime brick
- Solid sand-lime brick
- Solid brick
- Rebar connections
- Aerated concrete

Also suitable for:

- Concrete C12/15
- Hollow blocks made from concrete

CERTIFICATES

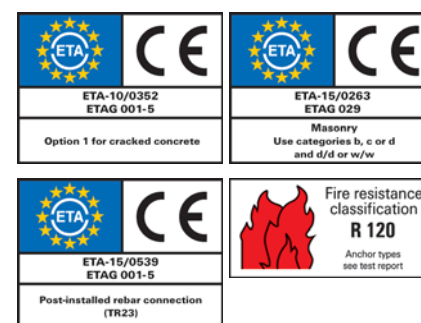

ADVANTAGES

- The FIS VL is approved for use in cracked concrete and masonry, and achieves a high load-bearing capacity in these conditions.
- The injection mortar, based on vinylester resin, allows for anchorings in water-filled drill holes (410 ml cartridges only), thus allowing for rapid progress.
- The temperature resistance of the FIS VL injection mortar of -40 °C to +120 °C allows for a solid load level even when subjected to high temperature demands, thus providing great flexibility.
- FIS VL HIGH SPEED has a significantly shorter curing time than FIS VL, thus also ensuring swift work progress even at low temperatures.

APPLICATIONS

Injection mortar for use with:

- Threaded rods FIS A, see page 146
- Internal threaded anchor RG MI, see page 159
- Injection anchor sleeves FIS H, see page 167

FUNCTIONING

- The FIS VL is a 2-component injection mortar based on vinylester.
- Resin and hardener are stored in two separate chambers and are not mixed and activated until extrusion through the static mixer.
- The 410 ml coaxial cartridge can be easily used with the fischer FIS AC dispenser.
- Partially used cartridges can be reused, simply by changing the static mixer.
- Related accessories for use in concrete and masonry can be found on page PL.

SEE ALSO



ANCHORS + SLEEVES

Page 144



DISPENSER

Page 195



ACCESSORIES

Page 198

INSTALLATION IN CONCRETE WITH FIS VL AND FIS A / RG M

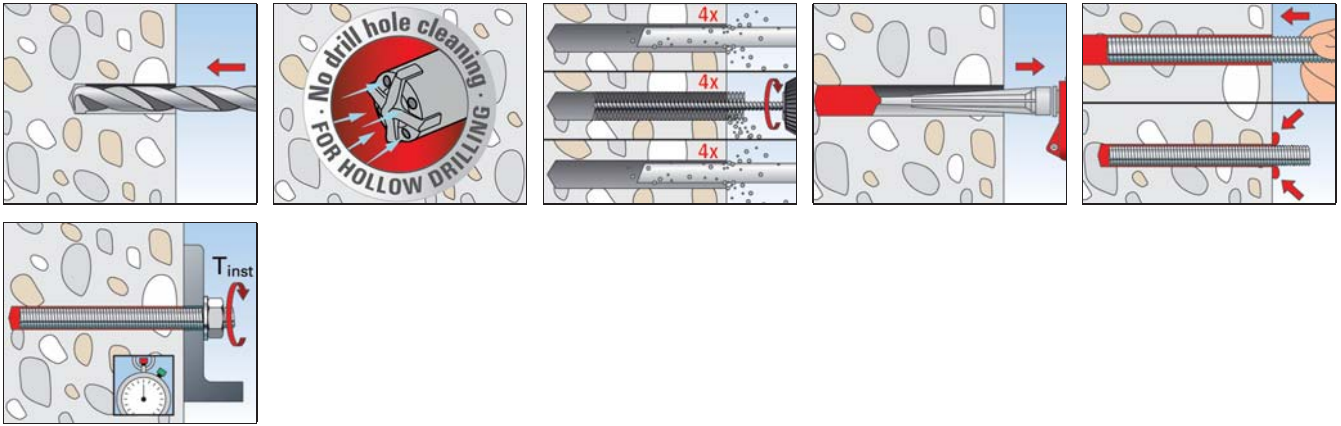

INSTALLATION IN CONCRETE WITH FIS VL AND RG M I

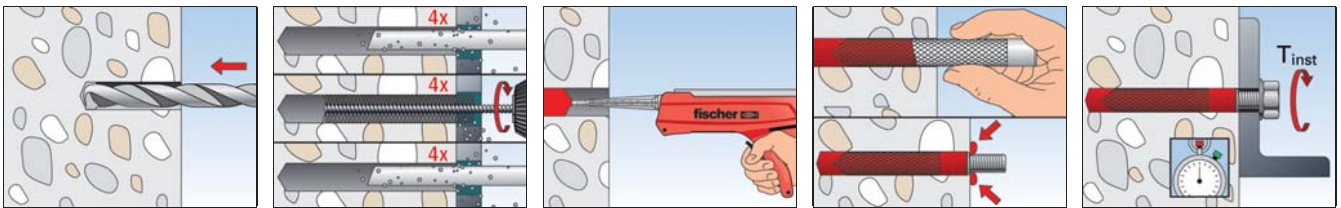

INSTALLATION IN SOLID BRICK WITH FIS VL AND FIS A / RG M

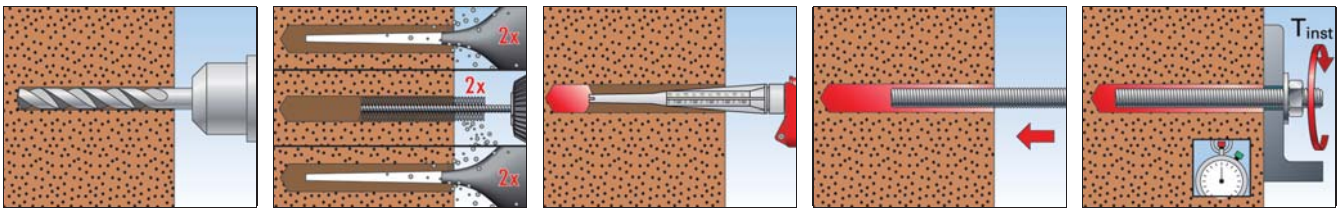

INSTALLATION IN HOLLOW BLOCKS WITH FIS VL AND FIS HK + FIS A / RG M

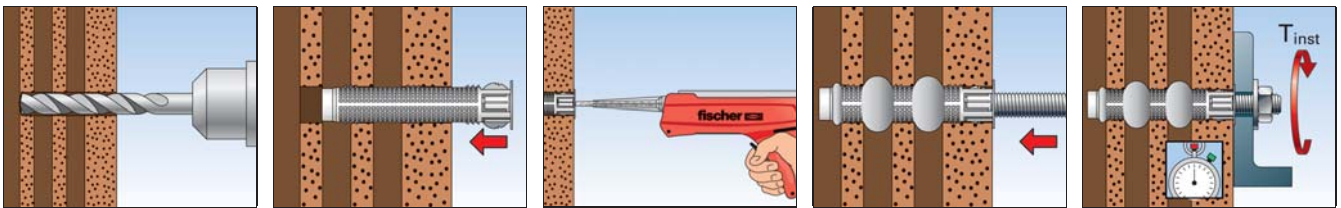

INSTALLATION IN AERATED CONCRETE WITH FIS V AND FIS A / RG M

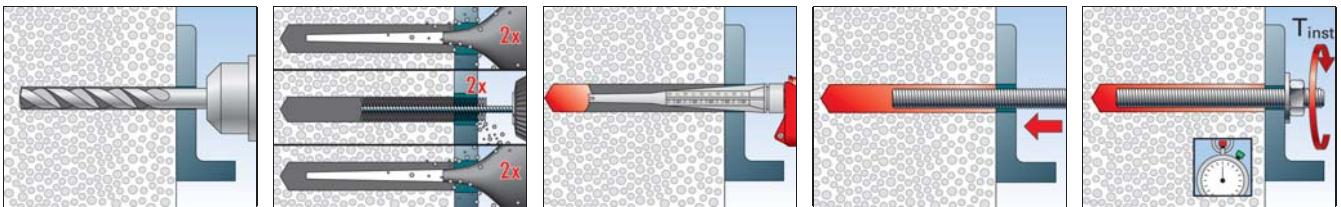

TECHNICAL DATA



FIS VL 300 T



FIS VL 410 C



FIS VL 410 C in bucket



Static mixer FIS MR Plus

Item	Art.-No.	Approval ETA	Languages on the cartridge	Scale unit	Contents	Sales unit [pcs]
FIS VL 300 T with clip	537149	■	PT, ES, EN	150	1 cartridge 300 ml, 2 x FIS MR Plus	12
FIS VL 300 T with clip	538583	■	CS, SK	150	1 cartridge 300 ml, 2 x FIS MR Plus	10
FIS VL 300 T HIGH SPEED with clip	538585	■	CS, SK	150	1 cartridge 380 ml, 2 x FIS MR Plus	10
FIS VL 300 T	539461	■	EN, FR, ES, PT, RO, AR	150	1 cartridge 300 ml, 2 x FIS MR Plus	12
FIS VL 300 T in bucket	539462	■	EN, FR, ES, PT, RO, AR	150	20 cartridges 300 ml, 40 x FIS MR Plus	1
FIS VL 300 T HWK big	538589	■	CS, SK	150	20 cartridges 300 ml, 40 x FIS MR Plus	1
FIS VL 410 C	539463	■	EN, FR, ES, PT, RO, AR	200	1 cartridge 410 ml, 2 x FIS MR Plus	12
FIS VL 410 C	538584	■	CS, SK	200	1 cartridge 410 ml, 2 x FIS MR Plus	12
FIS VL 410 C HIGH SPEED	538586	■	CS, SK	200	1 cartridges 410 ml, 1 x FIS MR Plus	12
FIS VL 410 C in bucket	538549	■	DE, FR, NL, EN, TR	200	16 cartridges 410 ml, 32 x FIS MR Plus	1
FIS VL 410 C in bucket	539464	■	EN, FR, ES, PT, RO, AR	200	16 cartridges 410 ml, 32 x FIS MR Plus	1
FIS VL 410 C HWK big	538590	■	CS, SK	200	16 cartridges 410 ml, 32 x FIS MR Plus	1
FIS MR Plus	545853	—	—	—	10 static mixer FIS MR Plus	10

CURING TIME FIS VL

Cartridge temperature (mortar)	Gelling time	Temperature at anchoring base	Curing time
		- 5°C - ± 0°C	24 hrs.
+ 0°C - + 5°C	13 min.	± 0°C - + 5°C	3 hrs.
+ 5°C - +10°C	9 min.	+ 5°C - +10°C	90 min.
+10°C - +20°C	5 min.	+10°C - +20°C	60 min.
+20°C - +30°C	4 min.	+20°C - +30°C	45 min.
+30°C - +40°C	2 min.	+30°C - +40°C	35 min.

The above times apply from the moment of contact between resin and hardener in the static mixer.

For installation, the cartridge temperature must be at least +5 °C. For longer installation times, i.e. when interruptions occur in work, the mixer should be replaced.

CURING TIME FIS VL HIGH SPEED

Cartridge temperature (mortar)	Gelling time	Temperature at anchoring base	Curing time
		-15°C - -10°C ¹⁾	12 hrs.
		-10°C - - 5°C ¹⁾	8 hrs.
- 5°C - ± 0°C ¹⁾	5 min.	- 5°C - ± 0°C	3 hrs.
0°C - + 5°C	5 min.	± 0°C - + 5°C	90 min.
+ 5°C - +10°C	3 min.	+ 5°C - +10°C	45 min.
+10°C - +20°C	1 min.	+10°C - +20°C	30 min.

¹⁾ Without approval.

The above times apply from the moment of contact between resin and hardener in the static mixer.

For installation, the cartridge temperature must be at least +5 °C. For longer installation times, i.e. when interruptions occur in work, the mixer should be replaced.

LOADS

Injection system FIS VL: Injection mortar FIS VL with Threaded rod FIS A ¹⁾

zinc plated steel / stainless steel

Permissible loads of a single anchor in cracked normal concrete (concrete tension zone) of strength class C20/25 (~B25) ^{2) 3) 4) 5) 11)}										Minimum spacings while reducing the load	
Type	Material fixing element	Min. member thickness	Effective anchorage depth	Maximum torque moment	Permissible tensile load	Permissible shear load	Required edge distance (with one edge) for		Required spacing for	Min. spacing	Min. edge distance
							Max. tension load c	Max. shear load c			
		h _{min} [mm]	h _{ef} ⁶⁾ [mm]	T _{max} [Nm]	N _{perm} ⁷⁾ [kN]	V _{perm} ⁷⁾ [kN]	[mm]	[mm]	[mm]	[mm]	[mm]
M10	5.8	100	60	20	4,5	8,6	90	185	180	45	45
		120	90		6,7		125	160	270		
		230	200		13,8		110	125	600		
	8.8	100	60		4,5	10,8	90	235	180		
		120	90		6,7	13,3	125	260	270		
		230	200		15,0		180	600			
	A4-70	100	60		4,5		9,3	90	200		
		120	90		6,7	125		175	270		
		230	200		15,0	130		600			
M12	5.8	100	70	40	6,3	12,0	105	255	210	55	55
		140	110		9,9		145	200	330		
		270	240		20,5		140	150	720		
	8.8	100	70		6,3	15,1	105	330	210		
		140	110		9,9	19,3	145	345	330		
		270	240		21,5		235	720			
	A4-70	100	70		6,3		13,5	105	290		
		140	110		9,9	145		230	330		
		270	240		21,5	165		720			
M16	5.8	120	80	60	9,6	22,3	120	445	240	65	65
		170	125		15,0		185	350	375		
		360	320		37,6		225	960			
	8.8	120	80		9,6	23,0	120	460	240		
		170	125		15,0	35,9	185	600	375		
		360	320		38,3		380	960			
	A4-70	120	80		9,6		23,0	120	460		
		170	125		15,0	25,2	185	400	375		
		360	320		38,3		250	960			
M20	5.8	140	90	120	12,2		29,3	135	530	270	85
		220	170		23,3	225		460	510		
		450	400		54,9	300		1200			
	8.8	140	90		12,2	29,3	135	530	270		
		220	170		23,3	56,0	225	785	510		
		450	400		54,9		520	1200			
	A4-70	140	90		12,2		29,3	135	530	270	
		220	170		23,3	39,3	225	525	510		
		450	400		54,9		345	1200			

For the design the complete assessment ETA-10/0352 has to be considered. ¹⁰⁾

¹⁾ Also valid for threaded rod RG M in the same property class.

²⁾ The partial safety factors for material resistance as regulated in the ETA-10/0352 as well as a partial safety factor for load actions of $\gamma_L = 1,4$ are considered. As a single anchor counts e.g. an anchor with a spacing $s \geq 3 \cdot h_{ef}$ and an edge distance $c \geq 1,5 \cdot h_{ef}$. Accurate data see ETA-10/0352.

³⁾ The given loads are valid for injection mortar FIS VL for fixations in dry and humid concrete for temperatures in the substrate up to 50 °C (resp. short term up to 80 °C. F or drill hole cleaning see ETA-10/0352.

⁴⁾ For higher concrete strength classes up to C50/60 higher permissible loads may be possible.

⁵⁾ Drill method hammer drilling. For further allowable application conditions see ETA-10/0352.

⁶⁾ For the sizes M10 - M20 the min. anchorage depth and the max. anchorage depth are given. The anchorage depth can be chosen freely between these borders.

⁷⁾ For combinations of tensile loads, shear loads, bending moments as well as reduced edge distances or spacings (anchor groups) see ETA-10/0352.

⁸⁾ Minimum possible axial spacings resp. edge distance while reducing the permissible load.

⁹⁾ Minimum possible spacing resp. edge distance while reducing the permissible load for the required minimum member thickness. The combination of minimum edge distance and minimum spacing is not possible. One of both values has to be increased acc. ETA-10/0352.

¹⁰⁾ The given loads refer to the European Technical Assessment ETA-10/0352, issue date 10/08/2017. Design of the loads according ETAG 001, Technical Report TR 029 (for static resp. quasi-static loads).

¹¹⁾ A reinforcement in the concrete to prevent splitting is required. The width of the cracks has to be limited under consideration of the splitting forces at $w_k \sim 0,3$ mm.

LOADS

Injection system FIS VL: Injection mortar FIS VL with Threaded rod FIS A ¹⁾

zinc plated steel / stainless steel

Permissible loads of a single anchor in non-cracked normal concrete (concrete compression zone) of strength class C20/25 (~B25) ²⁾³⁾⁴⁾⁵⁾										Minimum spacings while reducing the load		
Type	Material fixing element	Min. member thickness	Effective anchorage depth	Maximum torque moment	Permissible tensile load	Permissible shear load	Required edge distance (with one edge) for		Required spacing for	Min. spacing	Min. edge distance	
							Max. tension load c	Max. shear load c				Max. Load s _{cr}
		h _{min} [mm]	h _{ef} ⁶⁾ [mm]	T _{max} [Nm]	N _{perm} ⁶⁾ [kN]	V _{perm} ⁶⁾ [kN]	[mm]	[mm]	[mm]	[mm]	[mm]	
M6	5.8	100	50	5	3,4	2,9	65	50	150	40	40	
			60		4,0				180			
		110	72		4,8				220			
	8.8	100	50		3,4	4,6		70	150			
			60		4,0				180			
		110	72		4,8				220			
	A4-70	100	50	3,4	3,2	55	150					
			60	4,0			180					
		110	72	4,8			220					
M8	5.8	100	60	10	6,6	5,1	90	70	180	40	40	
			80		8,8				240			
		190	9,0		480							
	8.8	100	60		6,6	8,4		125	180			
			80		8,8				240			
		190	160		13,9				75			100
	A4-70	100	60	6,6	5,9	90	180					
			80	8,8			240					
		190	160	9,8			40	75	480			
M10	5.8	100	60	20	8,2	8,6	90	125	180	45	45	
			90		12,3				270			
		230	13,8		600							
	8.8	100	60		8,2	13,3		90	180			
			90		12,3				270			
		230	200		22,1				130			600
	A4-70	100	60	8,2	9,3	90	180					
			90	12,3			270					
		230	200	15,5			50	100	600			
M12	5.8	100	70	40	11,5	12,0	140	175	210	55	55	
			110		18,1				330			
		270	20,5		720							
	8.8	100	70		11,5	19,3		140	295			210
			110		18,1				330			
		270	240		32,1				110			170
	A4-70	100	70	11,5	13,5	140	200	210				
			110	18,1			330					
		270	240	22,5			60	130	720			
M16	5.8	120	80	60	14,3	22,3	160	305	240	65	65	
			125		24,9				375			
		360	320		37,6				80			175
	8.8	120	80		14,3	34,4		160	495			240
			125		24,9				375			
		360	320		59,8				230			255
	A4-70	120	80	14,3	25,2	160	350	240				
			125	24,9			375					
		360	320	42,0			100	190	960			

LOADS

Injection system FIS VL: Injection mortar FIS VL with Threaded rod FIS A ¹⁾

zinc plated steel / stainless steel

Permissible loads of a single anchor in non-cracked normal concrete (concrete compression zone) of strength class C20/25 (~B25) ²⁾³⁾⁴⁾⁵⁾										Minimum spacings while reducing the load						
Type	Material fixing element	Min. member thickness	Effective anchorage depth	Maximum torque moment	Permissible tensile load	Permissible shear load	Required edge distance (with one edge) for		Required spacing for	Min. spacing	Min. edge distance					
							Max. tension load c	Max. shear load c				Max. Load s _{cr}	s _{min} ⁸⁾⁹⁾	c _{min} ⁸⁾⁹⁾		
		h _{min} [mm]	h _{ef} ⁶⁾ [mm]	T _{max} [Nm]	N _{perm} ⁶⁾ [kN]	V _{perm} ⁶⁾ [kN]	[mm]	[mm]	[mm]	[mm]	[mm]					
M20	5.8	140	90	120	17,1	34,9	170	435	270	85	85					
		220	170		40,3		340	305	510							
		450	400		58,6		110	230	1200							
	8.8	140	90		17,1	41,1	170	525	270							
		220	170		40,3	56,0	340	530	510							
		450	400		93,3	375	350	1200								
	A4-70	140	90		17,1	39,3	170	500	270							
		220	170		40,3		340	350	510							
		450	400		65,5		135	255	1200							
	M24	5.8	160		96	150	18,8	45,2	170			540	290	105	105	
			270		210		56,5		50,9			435	400			630
			540		480		84,3		140			295	1440			
8.8		160	96	18,8	45,2		170	540	290							
		270	210	56,5	80,7		435	685	630							
		540	480	129,3	505		455	1440								
A4-70		160	96	18,8	45,2		170	540	290							
		270	210	56,5	56,6		435	455	630							
		540	480	94,4	205		320	1440								
M27		5.8	170	108	200		22,5	54,0	195	605	325	125	125			
			310	250			71,5		65,7	495	475					750
			600	540			109,5		200	345	1620					
	8.8	170	108	22,5		54,0	195	605	325							
		310	250	71,5		104,9	495	825	750							
		600	540	154,5		570	560	1620								
	A4-70	170	108	22,5		54,0	195	605	325							
		310	250	71,5		73,6	495	545	750							
		600	540	122,7		315	380	1620								
	M30	5.8	190	120		300	26,3	63,2	210	660	360			140	140	
			350	280			89,0		80,6	595	545					840
			670	600			133,8		270	395	1800					
8.8		190	120	26,3	63,2		210	660	360							
		350	280	89,0	128,2		595	940	840							
		670	600	190,7	700		645	1800								
A4-70		190	120	26,3	63,2		210	660	360							
		350	280	89,0	89,9		595	620	840							
		670	600	150,0	400		430	1800								

For the design the complete assessment ETA-10/0352 has to be considered. ¹⁰⁾

¹⁾ Also valid for threaded rod RG M in the same property class.

²⁾ The partial safety factors for material resistance as regulated in the ETA-10/0352 as well as a partial safety factor for load actions of $\gamma_L = 1.4$ are considered. As an single anchor counts e.g. an anchor with a spacing $s \geq 3 \cdot h_{ef}$ and an edge distance $c \geq 1.5 \cdot h_{ef}$. Accurate data see ETA-10/0352.

³⁾ The given loads are valid for injection mortar FIS VL for fixations in dry and humid concrete for temperatures in the substrate up to 50 °C (resp. short term up to 80 °C. For drill hole cleaning see ETA-10/0352.

⁴⁾ For higher concrete strength classes up to C50/60 higher permissible loads may be possible.

⁵⁾ Drill method hammer drilling. For further allowable application conditions see ETA-10/0352.

⁶⁾ For the sizes M6 - M30 the min. anchorage depth and the max. anchorage depth are given. The anchorage depth can be chosen freely between these borders.

⁷⁾ For combinations of tensile loads, shear loads, bending moments as well as reduced edge distances or spacings (anchor groups) see ETA-10/0352.

⁸⁾ Minimum possible axial spacings resp. edge distance while reducing the permissible load.

⁹⁾ Minimum possible spacing resp. edge distance while reducing the permissible load for the required minimum member thickness. The combination of minimum edge distance and minimum spacing is not possible. One of both values has to be increased acc. ETA-10/0352.

¹⁰⁾ The given loads refer to the European Technical Assessment ETA-10/0352, issue date 10/08/2017. Design of the loads according ETAG 001, Technical Report TR 029 (for static resp. quasi-static loads).

LOADS

Injection system FIS VL: Injection mortar FIS VL with Internal threaded anchor RG M I

zinc plated steel / stainless steel

Permissible loads of a single anchor in non-cracked normal concrete (concrete compression zone) of strength class C20/25 (~B25) ¹⁾²⁾³⁾										Minimum spacings while reducing the load	
Type	Screw material resp. screw surface	Min. member thickness h_{min} [mm]	Effective anchorage depth h_{ef} [mm]	Maximum torque moment T_{max} [Nm]	Permissible tensile load $N_{perm}^{4)}$ [kN]	Permissible shear load $V_{perm}^{4)}$ [kN]	Required edge distance (with one edge) for		Required spacing for Max. Load s_{cr} [mm]	Min. spacing $s_{min}^{5)6)}$ [mm]	Min. edge distance $c_{min}^{5)6)}$ [mm]
							Max. tension load c [mm]	Max. shear load c [mm]			
RG M8 I	5.8	120	90	10	9,0	5,3	95	65	270	55	55
	8.8				11,9	8,3	135	95			
	A4-70				9,9	5,9	110	70			
RG M10 I	5.8	130	90	20	13,8	8,3	140	90	270	65	65
	8.8				15,9	13,3	170	155			
	A4-70				15,7	9,3		100			
RG M12 I	5.8	170	125	40	19,8	12,1	190	110	375	75	75
	8.8					19,3		190			
	A4-70					13,5		125			
RG M16 I	5.8	210	160	80	29,8	22,4	240	180	480	95	95
	8.8					35,8		320			
	A4-70					25,1		205			
RG M20 I	5.8	270	200	120	45,6	35,4	330	245	600	125	125
	8.8					42,9		315			
	A4-70					39,4		280			

For the design the complete assessment ETA-10/0352 has to be considered. ⁷⁾

¹⁾ The partial safety factors for material resistance as regulated in the ETA-10/0352 as well as a partial safety factor for load actions of $\gamma_L = 1,4$ are considered. As an single anchor counts e.g. an anchor with a spacing $s \geq 3 \cdot h_{ef}$ and an edge distance $c \geq 1,5 \cdot h_{ef}$. Accurate data see ETA-10/0352.

²⁾ For higher concrete strength classes up to C50/60 higher permissible loads may be possible.

³⁾ Drill method hammer drilling. For further allowable application conditions see ETA-10/0352.

⁴⁾ For combinations of tensile loads, shear loads, bending moments as well as reduced edge distances or spacings (anchor groups) see ETA-10/0352.

⁵⁾ Minimum possible axial spacings resp. edge distance while reducing the permissible load.

⁶⁾ Minimum possible spacing resp. edge distance while reducing the permissible load for the required minimum member thickness. The combination of minimum edge distance and minimum spacing is not possible. One of both values has to be increased acc. ETA-10/0352.

⁷⁾ The given loads refer to the European Technical Assessment ETA-10/0352, issue date 10/08/2017. Design of the loads according ETAG 001, Technical Report TR 029 (for static resp. quasi-static loads).

LOADS

Injection system FIS VL with threaded rod FIS A⁴⁾

Highest permissible loads ¹⁾⁵⁾ for a single anchor in solid brick masonry (without injection anchor sleeve) for pre-positioned or push-through installation.

For the design the complete assessment ETA-15/0263 has to be considered.

Type	Compressive brick-strength f_b [N/mm ²]	Brick raw density ρ [kg/dm ³]	Minimum brick dimensions ⁶⁾ (L x W x H) [mm]	Min. effective-anchorage depth h_{ef} [mm]	Min. member thickness h_{min} [mm]	Maximum torque $T_{inst,max}$ [Nm]	Permissible tensile load ⁹⁾ N_{perm} [kN]	Permissible shear load ³⁾ V_{perm} [kN]	Characteristic spacing parallel to bed joint $s_{cr \parallel}$ [mm]	Characteristic spacing perpendicular to bed joint $s_{cr \perp}$ [mm]	Min. spacing ²⁾ $s_{min \parallel} / s_{min \perp}$ [mm]	Characteristic resp. min. edge distance ²⁾ $c_{cr} = c_{min}$ [mm]						
Solid brick Mz, NF acc. to EN 771-1																		
M8	≥10	≥1,8	240x115x71	50	115	10	1,14	0,71	150	75	150 / 75	100						
M10				50			1,00	1,14	150		150 / 75	100						
M10				80			1,43	1,14	240		240 / 75	100						
M10				200			2,43	3,40	240		240 / 75	150						
M12				50			0,86	1,14	150		150 / 75	100						
M12				80			1,51	1,14	240		240 / 75	100						
M12				200			3,20	2,43	240		240 / 75	150						
M8				≥20			≥1,8	240x115x71	50		115	10	1,57	1,14	150	75	150 / 75	100
M10									50				1,43	1,71	150		150 / 75	100
M10									80				2,00	1,71	240		240 / 75	100
M10									200				2,43	2,43	240		240 / 75	150
M12									50				1,29	1,57	150		150 / 75	100
M12	80	2,29	1,57		240	240 / 75			100									
M12	200	2,43	2,43	240	240 / 75	150												

LOADS

Injection system FIS VL with threaded rod FIS A⁴⁾

Highest permissible loads ¹⁾⁵⁾ for a single anchor in solid brick masonry (without injection anchor sleeve) for pre-positioned or push-through installation.

For the design the complete assessment ETA-15/0263 has to be considered.

Type	Compressive brick-strength f_b [N/mm ²]	Brick raw density ρ [kg/dm ³]	Minimum brick dimensions ⁶⁾ (L x W x H) [mm]	Min. effective anchorage depth h_{ef} [mm]	Min. member thickness h_{min} [mm]	Maximum torque $T_{inst,max}$ [Nm]	Permissible tensile load ³⁾ N_{perm} [kN]	Permissible shear load ³⁾ V_{perm} [kN]	Characteristic spacing parallel to bed joint $s_{cr \parallel}$ [mm]	Characteristic spacing perpendicular to bed joint $s_{cr \perp}$ [mm]	Min. spacing ²⁾ $s_{min \parallel} / s_{min \perp}$ [mm]	Characteristic resp. min. edge distance ²⁾ $c_{cr} = c_{min}$ [mm]							
Solid sand-lime brick KS acc. to EN 771																			
M8	≥ 10	≥ 1,8	240x115x71	50	115	10	0,71	1,14	240	75	240 / 75	100							
M10				50			0,71	1,14				100							
M10				80			0,71	1,14				100							
M10				200			2,43	1,14				150							
M12				50			0,71	1,43				100							
M12				80			0,71	1,43				100							
M12	200			2,43			1,43	150											
M8	≥ 20			≥ 1,8			240x115x71	50				115	10	1,00	1,57	240	75	240 / 75	100
M10								50						1,00	1,57				100
M10								80						1,00	1,57				100
M10								200						2,43	1,57				150
M12								50						1,00	2,00				100
M12		80	1,00		2,00	100													
M12	200	2,43	2,00		150														

¹⁾ The required partial safety factors for material resistance as well as a partial safety factor for load actions of $\gamma_L = 1,4$ are considered.

²⁾ Minimum feasible spacings resp. edge distance. Details as well as to the distances to joints see assessment.

³⁾ For combinations of tensile loads, shear loads, bending moments as well as reduced edge distances or spacings (anchor groups) see assessment.

⁴⁾ Zinc-plated, stainless steel A4 and high corrosion-resistant steel C.

⁵⁾ The given loads are valid for installation and use of fixations in dry masonry - use category d/d - for temperatures in the substrate up to +50 °C (resp. short term up to 80 °C) and drill hole cleaning according to assessment. The given brick types in combination with the permissible loads are an extract of the assessment.

⁶⁾ Hole patterns see assessment.

LOADS

Injection system FIS VL with threaded rod FIS A⁵⁾ and anchor sleeve FIS H..K

Highest permissible loads ¹⁾⁶⁾ for a single anchor in solid brick masonry (with injection anchor sleeve) for pre-positioned installation.

For the design the complete assessment ETA-15/0263 has to be considered.

Type of anchor sleeve with threaded rod	Compressive brick-strength f_b [N/mm ²]	Brick raw density ρ [kg/dm ³]	Minimum brick dimensions ⁶⁾ (L x W x H) [mm]	Min. effective anchorage depth ⁴⁾ h_{ef} [mm]	Min. member thickness h_{min} [mm]	Maximum torque $T_{inst,max}$ [Nm]	Permissible tensile load ³⁾ N_{perm} [kN]	Permissible shear load ³⁾ V_{perm} [kN]	Characteristic spacing parallel to bed joint $s_{cr \parallel}$ [mm]	Characteristic spacing perpendicular to bed joint $s_{cr \perp}$ [mm]	Min. spacing ²⁾ $s_{min \parallel} / s_{min \perp}$ [mm]	Characteristic resp. min. edge distance ²⁾ $c_{cr} = c_{min}$ [mm]								
Solid sand-lime brick KS acc. to EN 771																				
12x85 M8	≥ 10	≥ 1,8	240x115x113	85	115	2	1,71	0,86	240	115	240 / 115	100								
16x85 M10							1,00	1,00												
20x85 M12							2,43	1,00												
12x85 M8	≥ 20			≥ 1,8			240x115x113	85					115	2	2,43	1,29	240	115	240 / 115	100
16x85 M10															1,57	1,57				
20x85 M12															2,43	1,57				

¹⁾ The required partial safety factors for material resistance as well as a partial safety factor for load actions of $\gamma_L = 1,4$ are considered.

²⁾ Minimum feasible spacings resp. edge distance. Details as well as to the distances to joints see assessment.

³⁾ For combinations of tensile loads, shear loads, bending moments as well as reduced edge distances or spacings (anchor groups) see assessment.

⁴⁾ The maximum anchorage depth is corresponding with the relevant anchor sleeves FIS H..K (see technical data).

⁵⁾ Zinc-plated, stainless steel A4 and high corrosion-resistant steel C.

⁶⁾ The given loads are valid for installation and use of fixations in dry masonry - use category d/d - for temperatures in the substrate up to +50 °C (resp. short term up to 80 °C) and drill hole cleaning according to assessment. The given brick types in combination with the permissible loads are an extract of the assessment.

⁷⁾ Hole patterns see assessment.

LOADS

Injection system FIS VL with threaded rod FIS A⁵⁾ and anchor sleeve FIS H...K

Highest permissible loads^{1) 6)} for a single anchor in perforated brick masonry (with injection anchor sleeve) for pre-positioned installation. For the design the complete assessment ETA-15/0263 has to be considered.

Type of anchor sleeve with threaded rod	Compressive brick-strength f_b [N/mm ²]	Brick raw density ρ [kg/dm ³]	Minimum brick-dimensions ⁷⁾ (L x W x H) [mm]	Min. effective anchorage depth ⁴⁾ h_{ef} [mm]	Min. member thickness h_{min} [mm]	Maximum torque $T_{inst,max}$ [Nm]	Permissible tensile load ³⁾ N_{perm} [kN]	Permissible shear load ³⁾ V_{perm} [kN]	Characteristic spacing parallel to bed joint $s_{cr \parallel}$ [mm]	Characteristic spacing perpendicular to bed joint $s_{cr \perp}$ [mm]	Min. spacing ²⁾ $s_{min \parallel} / s_{min \perp}$ [mm]	Characteristic resp. min. edge distance ²⁾ $c_{cr} = c_{min}$ [mm]
Vertically perforated brick Hz, acc. to EN 771-1												
12x85 M8	≥ 10	≥ 0,9	240x175x113	85	175	2,0	1,14	1,14	240	115	240 / 115	100
16x85 M10							1,00	1,57				
20x85 M12							1,43	1,71				
Perforated sand-lime brick KSL acc. to EN 771-2												
12x85 M8	≥ 12	≥ 1,4	240x175x113	85	175	2,0	0,71	0,71	240	115	100 / 115	100
16x85 M8/M10							0,86	1,29				
20x85 M12							1,00	1,29				
12x85 M8	≥ 20						1,29	1,29				
16x85 M8/M10							1,43	2,14				
20x85 M12							1,71	2,14				
Lightweight concrete hollow block Hbl acc. to EN 771-3												
12x85 M8	≥ 4	≥ 1,0	362x240x240	85	240	2,0	0,86	0,57	365	240	365 / 240	80
16x85 M10												
20x85 M12												

¹⁾ The required partial safety factors for material resistance as well as a partial safety factor for load actions of $\gamma_L = 1,4$ are considered.

²⁾ Minimum feasible spacings resp. edge distance. Details as well as to the distances to joints see assessment.

³⁾ For combinations of tensile loads, shear loads, bending moments as well as reduced edge distances or spacings (anchor groups) see assessment.

⁴⁾ The maximum anchorage depth is corresponding with the relevant anchor sleeves FIS H...K (see technical data).

⁵⁾ Zinc-plated, stainless steel A4 and high corrosion-resistant steel C.

⁶⁾ The given loads are valid for installation and use of fixations in dry masonry - use category d/d - for temperatures in the substrate up to +50 °C (resp. short term up to 80 °C) and drill hole cleaning according to assessment. The given brick types in combination with the permissible loads are an extract of the assessment.

⁷⁾ Hole patterns see assessment.

LOADS

Injection system FIS VL with threaded rod FIS A⁴⁾

Highest permissible loads^{1) 5)} for a single anchor in aerated concrete.

For the design the complete assessment ETA-15/0263 has to be considered.

Type threaded rod	Compressive brick-strength f_b [N/mm ²]	Brick raw density ρ [kg/dm ³]	Minimum brick dimensions (L x W x H) [mm]	Min. effective anchorage depth h_{ef} [mm]	Min. member thickness h_{min} [mm]	Maximum torque $T_{inst,max}$ [Nm]	Permissible tensile load ³⁾ N_{perm} [kN]	Permissible shear load ³⁾ V_{perm} [kN]	Characteristic spacing parallel to bed joint $s_{cr \parallel}$ [mm]	Characteristic spacing perpendicular to bed joint $s_{cr \perp}$ [mm]	Min. spacing ²⁾ $s_{min \parallel} / s_{min \perp}$ [mm]	Characteristic resp. min. edge distance ²⁾ $c_{cr} = c_{min}$ [mm]
Aerated concrete acc. to EN 771-4												
M8	≥ 2	≥ 0,35					1	0,54	0,43			
M10							2	0,54	0,43			
M12							2	0,54	0,54			
M8	≥ 4	≥ 0,50		100	130		1	0,71	0,89	250	250	250
M10							2	0,89	0,71			
M12							2	0,89	0,89			
M8	≥ 6	≥ 0,65					1	1,25	1,07			
M10							2	1,79	1,07			
M12							2	1,79	1,25			

¹⁾ The required partial safety factors for material resistance as well as a partial safety factor for load actions of $\gamma_L = 1,4$ are considered.

²⁾ Minimum feasible spacings resp. edge distance. Details as well as to the distances to joints see assessment.

³⁾ For combinations of tensile loads, shear loads, bending moments as well as reduced edge distances or spacings (anchor groups) see assessment.

⁴⁾ Zinc-plated, stainless steel A4 and high corrosion-resistant steel C.

⁵⁾ The given loads are valid for installation and use of fixations in dry masonry - use category d/d - for temperatures in the substrate up to +50 °C (resp. short term up to 80 °C) and drill hole cleaning according to assessment. The given brick types in combination with the permissible loads are an extract of the assessment.

The first approved injection mortar made with renewable raw materials

3
Chemical fixings

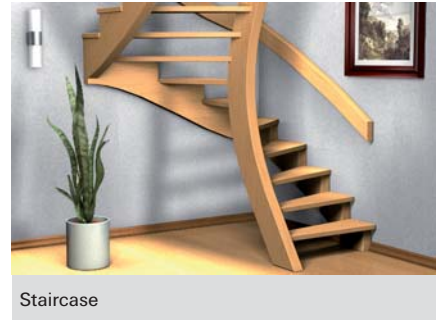

BUILDING MATERIALS

Approved for anchorings in:

- Concrete C20/25 to C50/60, non-cracked
- Solid brick
- Vertically perforated brick
- Solid sand-lime brick
- Perforated sand-lime brick
- Aerated concrete

CERTIFICATES

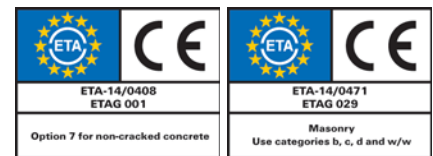

* Information sur le niveau d'émission de substances volatiles dans l'air intérieur, présentant un risque de toxicité par inhalation, sur une échelle de classe allant de A+ (très faibles émissions) à C (fortes émissions).



ADVANTAGES

- The worldwide first injection mortar with renewable raw materials. The share of renewable raw materials is certified by DIN CERTCO / TÜV Rheinland.
- Because of the European Technical Assessment it is possible to use the injection system in the area of public buildings.
- The low content of volatile organic compounds (VOC) has a positive effect for the evaluation of fixings in „Green Building“-projects.
- Biobased raw materials increase the residential and workplace quality and preserve valuable resources for future generations.
- The injection system is not mandatory for indication and thus reduces risks for installers and the environment.
- FIS GREEN is suitable for the use with the complete fischer injection accessories.

APPLICATIONS



Injection mortar for use with:

- Threaded rods FIS A, see page 144
- Internal threaded anchor RG MI, see page 159
- Rebar anchor FRA, see page 179
- Concrete steel bars, see page 185
- Injection anchor sleeves FIS H, see page 167
- NSF certificate verifies its suitability for applications in drinking water

FUNCTIONING

- FIS GREEN is a 2-component injection mortar.
- Resin and hardener are stored in two separate chambers and are not mixed and activated until extrusion through the static mixer.
- The injection cartridge are quick and easy to use with the fischer dispensers.
- Partially used cartridges can be reused by changing the static mixer.
- Related accessories for the various applications can be found on pages „non-cracked concrete“ and „masonry“.

SEE ALSO

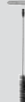
	ANCHORS + SLEEVES Page 144		DISPENSER Page 195		ACCESSORIES Page 198
---	--------------------------------------	---	------------------------------	---	--------------------------------

INSTALLATION IN CONCRETE WITH FIS GREEN AND FIS A / RG M

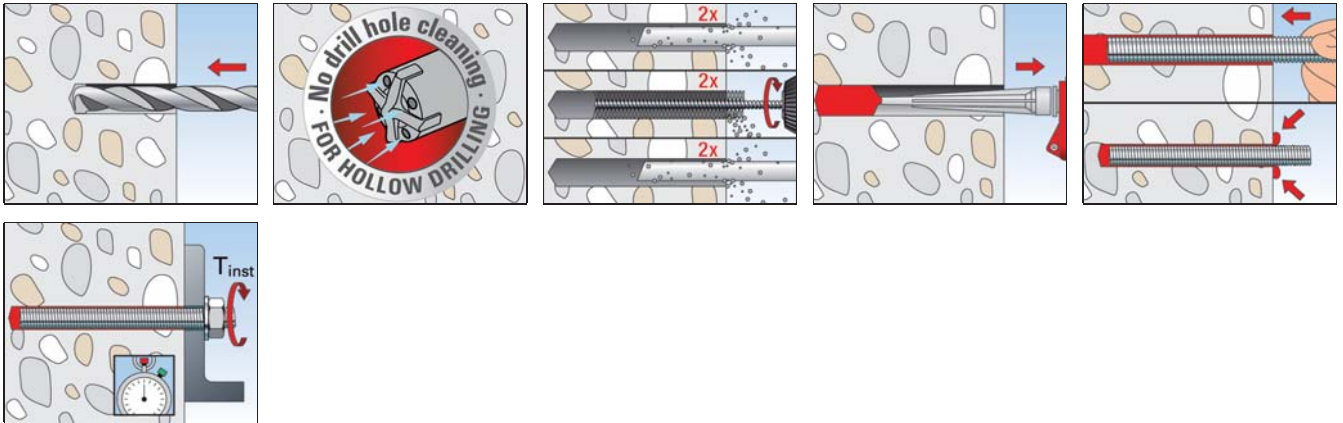

INSTALLATION IN CONCRETE WITH FIS GREEN AND RG M I

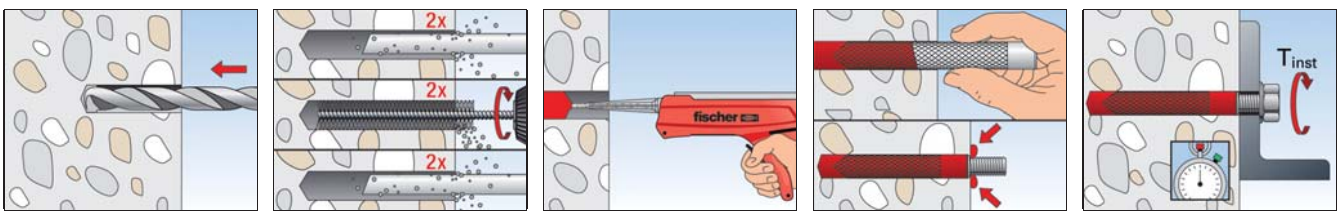

INSTALLATION IN SOLID BRICK WITH FIS GREEN AND FIS A / RG M

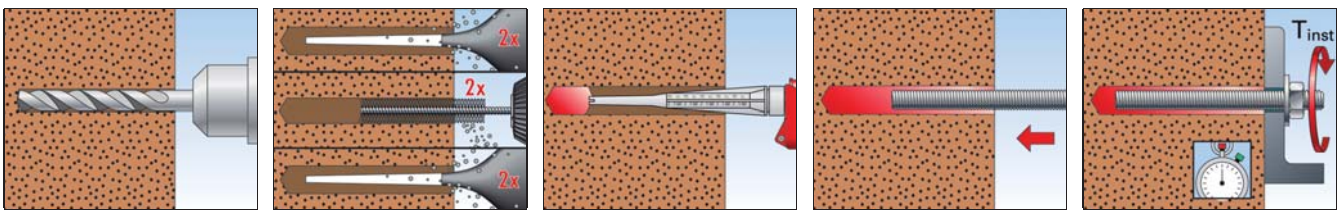

INSTALLATION IN HOLLOW BRICKS WITH FIS GREEN AND FIS HK + FIS A / RG M

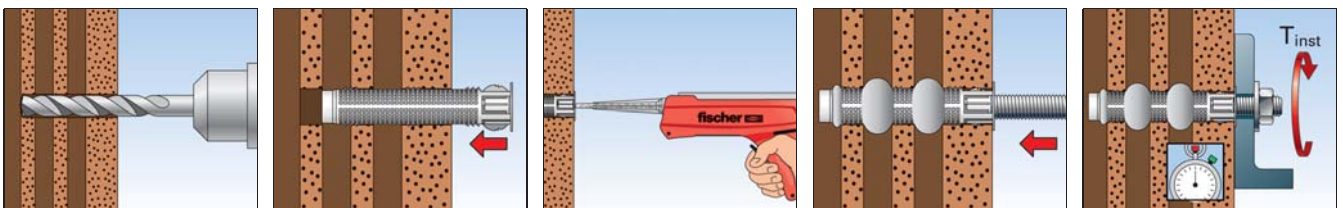

INSTALLATION IN AERATED CONCRETE WITH FIS GREEN AND FIS A / RG M

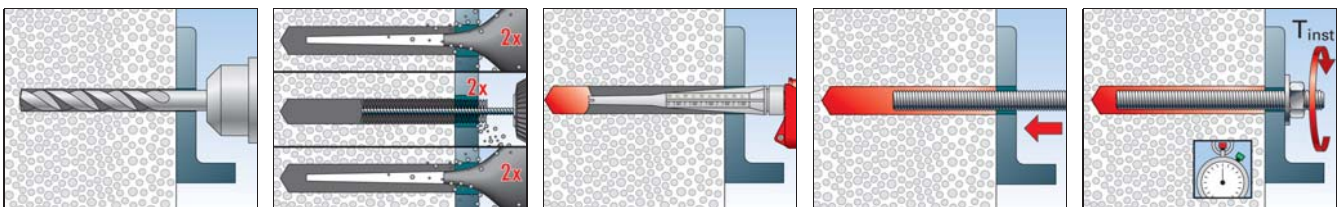

TECHNICAL DATA



FIS GREEN 300 T



Static mixer FIS MR Plus

Item	Art.-No.	Approval ETA	Languages on the cartridge	Scale unit	Contents	Sales unit [pcs]
FIS GREEN 300 T	522223	■	DE	150	1 cartridge 300 ml, 2 x FIS MR Plus	12
FIS GREEN 300 T K	523244	■	DE	150	1 Cartridge 300 ml, 2 x Static mixer (incl. clip with europerforation)	4
FIS GREEN 300 T	522989	■	FR	150	1 cartridge 300 ml, 2 x FIS MR Plus with transparent Clip	4
FIS GREEN 300 T	523245	■	IT	150	1 cartridge 300 ml, 2 x FIS MR Plus with transparent Clip	12
FIS GREEN 300 T	538219	■	CS, SK	150	1 cartridge 300 ml, 2 x FIS MR Plus	12
FIS GREEN 300 T	532972	■	DA, SV, NO, FI	150	1 cartridge 300 ml, 2 x FIS MR Plus with transparent Clip	12
FIS MR Plus	545853	—	—	—	10 static mixer FIS MR Plus	10

LOADS

Injection system FIS GREEN: Injection mortar FIS GREEN with Threaded rod FIS A ¹⁾

zinc plated steel / stainless steel / high corrosion resistant steel

Permissible loads of a single anchor in non-cracked normal concrete (concrete compression zone) of strength class C20/25 (~B25) ²⁾³⁾⁴⁾⁵⁾										Minimum spacings while reducing the load		
Type	Material fixing element	Min. member thickness h_{min} [mm]	Effective anchorage depth $h_{ef}^{6)}$ [mm]	Maximum torque moment T_{max} [Nm]	Permissible tensile load $N_{perm}^{7)}$ [kN]	Permissible shear load $V_{perm}^{7)}$ [kN]	Required edge distance (with one edge) for		Required spacing for Max. Load s_{cr} [mm]	Min. spacing $s_{min}^{8)9)}$ [mm]	Min. edge distance $c_{min}^{8)9)}$ [mm]	
							Max. tension load c [mm]	Max. shear load c [mm]				
M8	5.8	100	60	10	5,7	5,1	90	70	180	40	40	
		110	80		7,6				240			
		190	160		9,0		40	60	480			
	8.8	100	60		5,7	8,6	90	130	180			240
		110	80		7,6							115
		190	160		14,3		85	90	480			
	A4-70	100	60		5,7	6,0	90	85	180			240
		110	80		7,6							75
		190	160		9,9		50	70	480			
	C-70	100	60		5,7	7,4	90	110	180			240
		110	80		7,6							100
		190	160		12,4		70	80	480			
M10	5.8	100	60	20	6,7	8,6	90	125	180	45	45	
		120	90		10,1				110			105
		230	200		13,8		55	85	600			
	8.8	100	60		6,7	13,1	90	200	180			270
		120	90		10,1							110
		230	200		22,4		115	115	600			
	A4-70	100	60		6,7	9,2	90	135	180			270
		120	90		10,1							110
		230	200		15,7		65	90	600			
	C-70	100	60		6,7	11,4	90	170	180			270
		120	90		10,1							110
		230	200		19,5		95	105	600			

LOADS

Injection system FIS GREEN: Injection mortar FIS GREEN with Threaded rod FIS A ¹⁾

zinc plated steel / stainless steel / high corrosion resistant steel

Permissible loads of a single anchor in non-cracked normal concrete (concrete compression zone) of strength class C20/25 (~B25) ²⁾³⁾⁴⁾⁵⁾										Minimum spacings while reducing the load					
Type	Material fixing element	Min. member thickness	Effective anchorage depth	Maximum torque moment	Permissible tensile load	Permissible shear load	Required edge distance (with one edge) for		Required spacing for	Min. spacing	Min. edge distance				
							Max. tension load c	Max. shear load c				Max. Load s _{cr}	s _{min} ⁸⁾⁹⁾	c _{min} ⁸⁾⁹⁾	
		h _{min} [mm]	h _{ef} ⁶⁾ [mm]	T _{max} [Nm]	N _{perm} ⁷⁾ [kN]	V _{perm} ⁷⁾ [kN]	[mm]	[mm]	[mm]	[mm]	[mm]				
M12	5.8	100	70	40	8,9	12,0	105	175	210	55	55				
		140	110		14,0		130	130	330						
		270	240		20,5		70	100	720						
	8.8	100	70		8,9	19,4	105	295	210			130	230	330	
		140	110		14,0			150	720						
		270	240		30,5			200	210						
	A4-70	100	70		8,9	13,7	105	200	210			130	155	330	
		140	110		14,0			85	115						720
		270	240		22,5			105	260						210
	C-70	100	70		8,9	17,1	105	260	210			130	200	330	
		140	110		14,0			115	135						720
		270	240		28,1			125	305						240
M16	5.8	120	80	60	12,0	22,3	125	305	240	65	65				
		170	125		18,7		160	235	375						
		360	320		37,6		115	150	960						
	8.8	120	80		12,0	28,7	125	405	240			160	220	960	
		170	125		18,7			36,0	375						
		360	320		47,9			125	350						240
	A4-70	120	80		12,0	25,2	125	350	240			160	270	375	
		170	125		18,7			135	165						960
		360	320		42,0			125	405						240
	C-70	120	80		12,0	28,7	125	405	240			160	350	375	
		170	125		18,7			195	960						
		360	320		47,9			135	165						960
	M20	5.8	140		90	120	14,6	34,9	135			435	270	85	85
			220		170		27,6		190			300	510		
			450		400		58,6		165			195	1200		
8.8		140	90	14,6	35,0		135	440	270	190	525	510			
		220	170	27,6				290	1200						
		450	400	64,8				135	440				270		
A4-70		140	90	14,6	35,0		135	440	270	190	350	510			
		220	170	27,6				215	1200						
		450	400	64,8				135	440				270		
C-70		140	90	14,6	35,0		135	440	270	190	455	510			
		220	170	27,6				260	1200						
		450	400	64,8				49,1	260				1200		

For the design the complete assessment ETA-14/0408 has to be considered. ¹⁰⁾

¹⁾ Also valid for threaded rod RG M in the same property class.

²⁾ The partial safety factors for material resistance as regulated in the ETA-14/0408 as well as a partial safety factor for load actions of $\gamma_L = 1,4$ are considered. As an single anchor counts e.g. an anchor with a spacing $s \geq 3 \cdot h_{ef}$ and an edge distance $c \geq 1,5 \cdot h_{ef}$. Accurate data see ETA-14/0408.

³⁾ The given loads are valid for injection mortar FIS GREEN for fixations in dry and humid concrete for temperatures in the substrate up to 50 °C (resp. short term up to 80 °C. For drill hole cleaning see ETA-14/0408.

⁴⁾ For higher concrete strength classes up to C50/60 higher permissible loads may be possible.

⁵⁾ Drill method hammer drilling.

⁶⁾ For the sizes M8 - M20 the min. anchorage depth and the max. anchorage depth are given. The anchorage depth can be chosen freely between these borders.

⁷⁾ For combinations of tensile loads, shear loads, bending moments as well as reduced edge distances or spacings (anchor groups) see ETA-14/0408.

⁸⁾ Minimum possible axial spacings resp. edge distance while reducing the permissible load.

⁹⁾ Minimum possible spacing resp. edge distance while reducing the permissible load for the required minimum member thickness. The combination of minimum edge distance and minimum spacing is not possible. One of both values has to be increased acc. ETA-14/0408.

¹⁰⁾ The given loads refer to the European Technical Assessment ETA-14/0408, issue date 19/12/2014. Design of the loads according ETAG 001, Technical Report TR 029 (for static resp. quasi-static loads).

LOADS

Injection system FIS GREEN: Injection resin FIS GREEN with Internal threaded anchor RGMI
zinc plated steel / stainless steel A4

Permissible loads of a single anchor in non-cracked normal concrete (concrete compression zone) of strength class C20/25 (~ B25) ¹⁾²⁾³⁾										Minimum spacings while reducing the load				
Type	Screw steel property/surface	Min. member thickness	Effective anchorage depth	Maximum torque moment	Permissible tensile load	Permissible shear load	Required edge distance (with one edge) for		Required spacing for	Min. spacing	Min. edge distance			
							Max. tension load c	Max. shear load c						
		h_{min} [mm]	h_{ef} [mm]	T_{max} [Nm]	$N_{perm}^{4)}$ [kN]	$V_{perm}^{4)}$ [kN]	[mm]	[mm]	Max. Load s_{cr} [mm]	$s_{min}^{5)}$ [mm]	$c_{min}^{5)}$ [mm]			
RG M8 I	5.8	120	90	10	9,0	5,3	95	65	270	55	55			
	8.8				11,9	8,3	135	95						
	A4-70				9,9	5,9	110	70						
RG M10 I	5.8	130	90	20	13,8	8,3	145	90	270	65	65			
	8.8				13,3	9,3		155				100		
	A4-70				9,3	9,3		100				100		
RG M12 I	5.8	170	125	40	20,2	12,1	190	110	375	75	75			
	8.8							19,3				125	190	125
	A4-70							13,5				125	125	125
RG M16 I	5.8	210	160	80	27,8	22,4	240	180	480	95	95			
	8.8							30,9				265	265	
	A4-70							25,1				205	205	

For the design the complete assessment ETA-14/0408 has to be considered. ⁶⁾

¹⁾ The partial safety factors for material resistance as regulated in the ETA-14/0408 as well as a partial safety factor for load actions of $\gamma_L = 1.4$ are considered. As an single anchor counts e.g. an anchor with a spacing $s \geq 3 \cdot h_{ef}$ and an edge distance $c \geq 1.5 \cdot h_{ef}$. Accurate data see ETA-14/0408.

²⁾ For higher concrete strength classes up to C50/60 higher permissible loads may be possible.

³⁾ Drill method hammer drilling. For further allowable application conditions see ETA-14/0408.

⁴⁾ For combinations of tensile loads and shear loads or for shear loads with lever arm (bending moments) as well as reduced edge distances or spacings (anchor groups) we recommend to use our anchor design software C-FIX.

⁵⁾ Minimum possible axial spacings resp. edge distance while reducing the permissible load.

⁶⁾ The given loads refer to the European Technical Assessment ETA-14/0408, issue date 19/12/2014. Design of the loads according ETAG 001, Technical Report TR 029 (for static resp. quasi-static loads).

LOADS

Injection system FIS GREEN with threaded rod FIS A⁴⁾

Highest permissible loads ¹⁾⁵⁾ for a single anchor in solid brick masonry (without injection anchor sleeve) for pre-positioned or push-through installation.

For the design the complete assessment ETA-14/0471 has to be considered.

Type	Compressive brick strength	Brick raw density	Minimum brick dimensions ⁶⁾	Min. effective anchorage depth	Min. member thickness	Maximum torque	Permissible tensile load ³⁾	Permissible shear load ³⁾	Characteristic spacing parallel to bed joint	Characteristic spacing perpendicular to bed joint	Min. spacing ²⁾	Characteristic resp. min. edge distance ²⁾				
	f_b	ρ	(L x W x H)	h_{ef}	h_{min}	$T_{inst,max}$	N_{perm}	V_{perm}	$s_{cr \parallel}$	$s_{cr \perp}$	$s_{min \parallel} / s_{min \perp}$	$c_{cr} = c_{min}$				
	[N/mm ²]	[kg/dm ³]	[mm]	[mm]	[mm]	[Nm]	[kN]	[kN]	[mm]	[mm]	[mm]	[mm]				
Solid brick Mz, NF acc. to EN 771-1																
M8	≥10	≥1,8	240x115x71 (NF)	50	80	10	0,71	0,71	150	150	150	100				
M10				50	80		0,86	1,14	150	150	150	100				
M10				80	110		1,29	1,14	240	240	240	100				
M10				200	230		3,14	2,43	300	300	300	150				
M12				50	80		0,86	1,14	150	150	150	100				
M12				80	110		1,43	1,14	240	240	240	100				
M12				200	230		2,00	3,29	300	300	300	150				
M8				≥20	≥1,8		240x115x71 (NF)	50	80	10	0,71	1,14	150	150	150	100
M10								50	80		1,29	1,71	150	150	150	100
M10								80	110		1,71	1,71	240	240	240	100
M10	200	230	3,43			3,43		300	300		300	150				
M12	50	80	1,14			1,57		150	150		150	100				
M12	80	110	2,00			1,57		240	240		240	100				
M12				200	230	2,86	3,43	300	300	300	150					

LOADS

Injection system FIS GREEN with threaded rod FIS A⁴⁾

Highest permissible loads^{1) 5)} for a single anchor in solid brick masonry (without injection anchor sleeve) for pre-positioned or push-through installation.

For the design the complete assessment ETA-14/0471 has to be considered.

Type	Compressive brick-strength f_b [N/mm ²]	Brick raw density ρ [kg/dm ³]	Minimum brick dimensions ⁶⁾ (L x W x H) [mm]	Min. effective anchorage depth h_{ef} [mm]	Min. member thickness h_{min} [mm]	Maximum torque $T_{inst,max}$ [Nm]	Permissible tensile load ³⁾ N_{perm} [kN]	Permissible shear load ³⁾ V_{perm} [kN]	Characteristic spacing parallel to bed joint $s_{cr \parallel}$ [mm]	Characteristic spacing perpendicular to bed joint $s_{cr \perp}$ [mm]	Min. spacing ²⁾ $s_{min \parallel} / s_{min \perp}$ [mm]	Characteristic resp. min. edge distance ²⁾ $c_{cr} = c_{min}$ [mm]			
Solid sand-lime brick KS acc. to EN 771															
M8	≥ 10	≥ 1,8	240x115x71 (NF)	50	80	10	0,71	1,14	150	150	150	100			
M10				50	80		0,71	1,14	150	150	150	100			
M10				80	110		0,86	1,14	240	240	240	100			
M10				200	230		2,57	1,14	300	300	300	150			
M12				50	80		0,57	1,43	150	150	150	100			
M12				80	110		0,86	1,43	240	240	240	100			
M12				200	230		2,57	1,43	300	300	300	150			
M8				≥ 20	≥ 1,8		240x115x71 (NF)	50	80	0,71	1,57	150	150	150	100
M10								50	80	0,86	1,57	150	150	150	100
M10								80	110	1,14	1,57	240	240	240	100
M10								200	230	3,43	1,57	300	300	300	150
M12								50	80	0,86	2,00	150	150	150	100
M12	80	110	1,29			2,00		240	240	240	100				
M12	200	230	3,43			2,00		300	300	300	150				

¹⁾ The required partial safety factors for material resistance as well as a partial safety factor for load actions of $\gamma_L = 1,4$ are considered.

²⁾ Minimum feasible spacings resp. edge distance. Details as well as to the distances to joints see assessment.

³⁾ For combinations of tensile loads, shear loads, bending moments as well as reduced edge distances or spacings (anchor groups) see assessment.

⁴⁾ Zinc-plated, stainless steel A4 and high corrosion-resistant steel C.

⁵⁾ The given loads are valid for installation and use of fixations in dry masonry - use category d/d - for temperatures in the substrate up to +50 °C (resp. short term up to 80 °C) and drill hole cleaning according to assessment. The given brick types in combination with the permissible loads are an extract of the assessment.

⁶⁾ Hole patterns see assessment.

LOADS

Injection system FIS GREEN with threaded rod FIS A⁵⁾ and anchor sleeve FIS H..K

Highest permissible loads^{1) 6)} for a single anchor in solid brick masonry (with injection anchor sleeve) for pre-positioned installation.

For the design the complete assessment ETA-14/0471 has to be considered.

Type of anchor sleeve with threaded rod	Compressive brick-strength f_b [N/mm ²]	Brick raw density ρ [kg/dm ³]	Minimum brick dimensions ⁶⁾ (L x W x H) [mm]	Min. effective anchorage depth ⁴⁾ h_{ef} [mm]	Min. member thickness h_{min} [mm]	Maximum torque $T_{inst,max}$ [Nm]	Permissible tensile load ³⁾ N_{perm} [kN]	Permissible shear load ³⁾ V_{perm} [kN]	Characteristic spacing parallel to bed joint $s_{cr \parallel}$ [mm]	Characteristic spacing perpendicular to bed joint $s_{cr \perp}$ [mm]	Min. spacing ²⁾ $s_{min \parallel} / s_{min \perp}$ [mm]	Characteristic resp. min. edge distance ²⁾ $c_{cr} = c_{min}$ [mm]
Solid sand-lime brick KS acc. to EN 771												
12x85 M8	≥ 10	≥ 1,8	240x115x113	85	115	2	0,86	0,86	255	255	255	100
16x85 M10						4	0,57	1,00				
20x85 M12						4	1,57	1,00				
12x85 M8	≥ 20			85	115	2	1,29	1,29				
16x85 M10						4	0,86	1,57				
20x85 M12						4	2,29	1,57				

¹⁾ The required partial safety factors for material resistance as well as a partial safety factor for load actions of $\gamma_L = 1,4$ are considered.

²⁾ Minimum feasible spacings resp. edge distance. Details as well as to the distances to joints see assessment.

³⁾ For combinations of tensile loads, shear loads, bending moments as well as reduced edge distances or spacings (anchor groups) see assessment.

⁴⁾ The maximum anchorage depth is corresponding with the relevant anchor sleeves FIS H..K (see technical data).

⁵⁾ Zinc-plated, stainless steel A4 and high corrosion-resistant steel C.

⁶⁾ The given loads are valid for installation and use of fixations in dry masonry - use category d/d - for temperatures in the substrate up to +50 °C (resp. short term up to 80 °C) and drill hole cleaning according to assessment. The given brick types in combination with the permissible loads are an extract of the assessment.

⁷⁾ Hole patterns see assessment.

LOADS

Injection system FIS GREEN with threaded rod FIS A⁵⁾ and anchor sleeve FIS H..K

Highest permissible loads^{1) 6)} for a single anchor in perforated brick masonry (with injection anchor sleeve) for pre-positioned installation. For the design the complete assessment ETA-14/0471 has to be considered.

Type of anchor sleeve with threaded rod	Compressive brick-strength f_b [N/mm ²]	Brick raw density ρ [kg/dm ³]	Minimum brick-dimensions ⁷⁾ (L x W x H) [mm]	Min. effective-anchorage depth ⁴⁾ h_{ef} [mm]	Min. member thickness h_{min} [mm]	Maximum torque $T_{inst,max}$ [Nm]	Permissible tensile load ³⁾ N_{perm} [kN]	Permissible shear load ³⁾ V_{perm} [kN]	Characteristic spacing parallel to bed joint $s_{cr \parallel}$ [mm]	Characteristic spacing perpendicular to bed joint $s_{cr \perp}$ [mm]	Min. spacing ²⁾ $s_{min \parallel} / s_{min \perp}$ [mm]	Characteristic resp. min. edge distance ²⁾ $c_{cr} = c_{min}$ [mm]
Vertically perforated brick Hz, acc. to EN 771-1												
12x85 M6/M8	≥ 8	≥ 1,4	230x108x55	85	115	2,0	0,57	0,71	230	55	230 / 55	100
16x85 M8/M10												
20x85 M12/M16												
12x85 M6/M8	≥ 10	≥ 0,9	240x175x113	85	175	2,0	0,57	1,14	240	115	240 / 115	120
16x85 M8/M10							0,57	1,57				
20x85 M12/M16							0,71	1,71				
Perforated sand-lime brick KSL acc. to EN 771-2												
12x85 M6/M8	≥ 12	≥ 1,4	240x175x113	85	175	2,0	0,34	0,71	240	115	240 / 115	100
16x85 M8/M10							0,57	1,57				
20x85 M12/M16							0,57	1,29				
12x85 M6/M8	≥ 20	≥ 1,4	240x175x113	85	175	2,0	0,57	1,29	240	115	240 / 115	100
16x85 M8/M10							1,00	2,29				
20x85 M12/M16							1,00	2,14				

¹⁾ The required partial safety factors for material resistance as well as a partial safety factor for load actions of $\gamma_L = 1,4$ are considered.

²⁾ Minimum feasible spacings resp. edge distance. Details as well as to the distances to joints see assessment.

³⁾ For combinations of tensile loads, shear loads, bending moments as well as reduced edge distances or spacings (anchor groups) see assessment.

⁴⁾ The maximum anchorage depth is corresponding with the relevant anchor sleeves FIS H..K (see technical data).

⁵⁾ Zinc-plated, stainless steel A4 and high corrosion-resistant steel C.

⁶⁾ The given loads are valid for installation and use of fixations in dry masonry - use category d/d - for temperatures in the substrate up to +50 °C (resp. short term up to 80 °C) and drill hole cleaning according to assessment. The given brick types in combination with the permissible loads are an extract of the assessment.

⁷⁾ Hole patterns see assessment.

LOADS

Injection system FIS GREEN with threaded rod FIS A⁴⁾

Highest permissible loads^{1) 5)} for a single anchor in aerated concrete.

For the design the complete assessment ETA-14/0471 has to be considered.

Type threaded rod	Compressive brick-strength f_b [N/mm ²]	Brick raw density ρ [kg/dm ³]	Minimum brick dimensions (L x W x H) [mm]	Min. effective-anchorage depth h_{ef} [mm]	Min. member thickness h_{min} [mm]	Maximum torque $T_{inst,max}$ [Nm]	Permissible tensile load ³⁾ N_{perm} [kN]	Permissible shear load ³⁾ V_{perm} [kN]	Characteristic spacing parallel to bed joint $s_{cr \parallel}$ [mm]	Characteristic spacing perpendicular to bed joint $s_{cr \perp}$ [mm]	Min. spacing ²⁾ $s_{min \parallel} / s_{min \perp}$ [mm]	Characteristic resp. min. edge distance ²⁾ $c_{cr} = c_{min}$ [mm]	
Aerated concrete acc. to EN 771-4													
M8	≥ 2	≥ 0,35					1	0,71	0,32	240	115	240 / 115	80
M10							2	0,71	0,32				
M12							2	0,89	0,32				
M16							2	0,89	0,43				
M8	≥ 4	≥ 0,50		100	130		1	0,89	0,54	240	115	240 / 115	80
M10							2	1,07	0,54				
M12							2	1,07	0,54				
M16							2	1,07	0,54				
M8	≥ 6	≥ 0,65					1	1,25	0,89	240	115	240 / 115	80
M10							2	1,43	0,89				
M12							2	1,43	0,89				
M16							2	1,43	0,71				

¹⁾ The required partial safety factors for material resistance as well as a partial safety factor for load actions of $\gamma_L = 1,4$ are considered.

²⁾ Minimum feasible spacings resp. edge distance. Details as well as to the distances to joints see assessment.

³⁾ For combinations of tensile loads, shear loads, bending moments as well as reduced edge distances or spacings (anchor groups) see assessment.

⁴⁾ Zinc-plated, stainless steel A4 and high corrosion-resistant steel C.

⁵⁾ The given loads are valid for installation and use of fixations in dry masonry - use category d/d - for temperatures in the substrate up to +50 °C (resp. short term up to 80 °C) and drill hole cleaning according to assessment. The given brick types in combination with the permissible loads are an extract of the assessment.

The approved injection mortar for anchorings in masonry and non-cracked concrete



Cable duct



Air conditioning units

BUILDING MATERIALS

- Concrete C20/25 to C50/60, non-cracked
- Vertically perforated brick
- Perforated sand-lime brick
- Solid sand-lime brick
- Perforated blocks made from lightweight concrete
- Solid brick
- Aerated concrete

Also suitable for:

- Solid brick made from lightweight concrete

ASSESSMENT/APPROVAL



ADVANTAGES

- With FIS P Plus, anchorings in masonry and non-cracked concrete for which approval is relevant can be realised in a particularly economical manner.
- FIS P Plus 300 T can be used with stable, standard silicone injection dispensers. No special equipment is required. As a result, procurement costs can be reduced on the basis of polyester resin.

APPLICATIONS

Injection mortar for use in masonry and non-cracked concrete with:

- Threaded rods FIS A, see pages 146
- Injection anchor sleeves FIS H K, see page 167
- Injection push-through anchor sleeve FIS H K, see page 164

FUNCTIONING

- FIS P Plus is a 2-component injection mortar based on polyester resin.
- Resin and hardener are stored in two separate chambers and are not mixed and activated until extrusion through the static mixer.
- Partially used cartridges can be reused, simply by changing the static mixer.
- Related accessories for use in masonry and non-cracked concrete can be found on page PL.

SEE ALSO



ANCHORS + SLEEVES

Page 144



DISPENSER

Page 195



ACCESSORIES

Page 198

INSTALLATION IN CONCRETE WITH FIS P PLUS AND FIS A / RG M

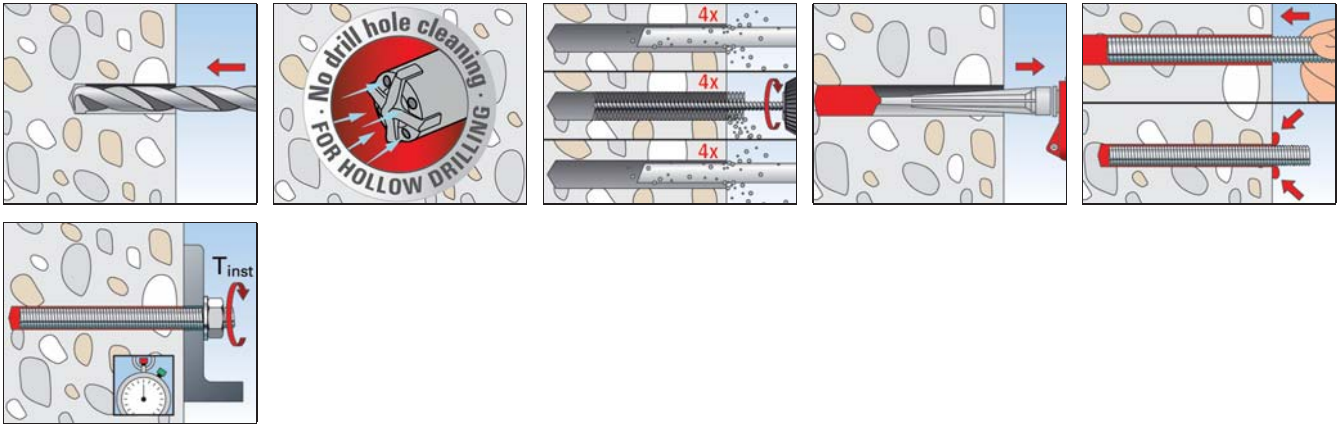

INSTALLATION IN CONCRETE WITH FIS P PLUS AND RG M I

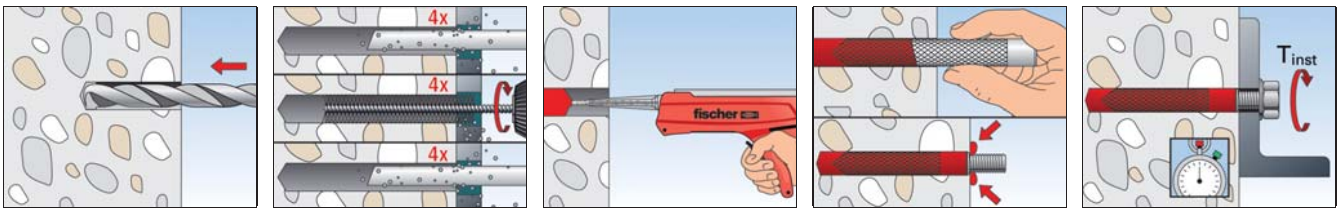

INSTALLATION IN SOLID BRICK WITH FIS P PLUS AND FIS A / RG M

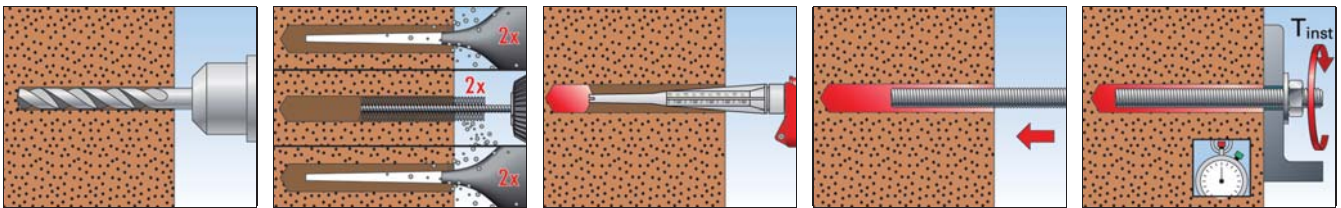

INSTALLATION IN HOLLOW BRICKS WITH FIS P PLUS AND FIS HK + FIS A / RG M

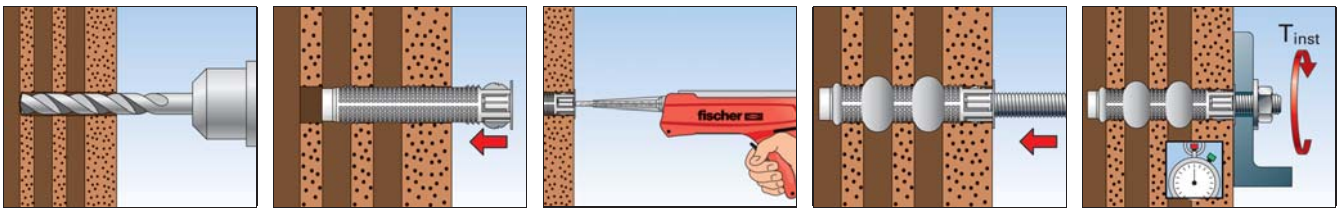

INSTALLATION IN AERATED CONCRETE WITH FIS P PLUS AND FIS A / RG M

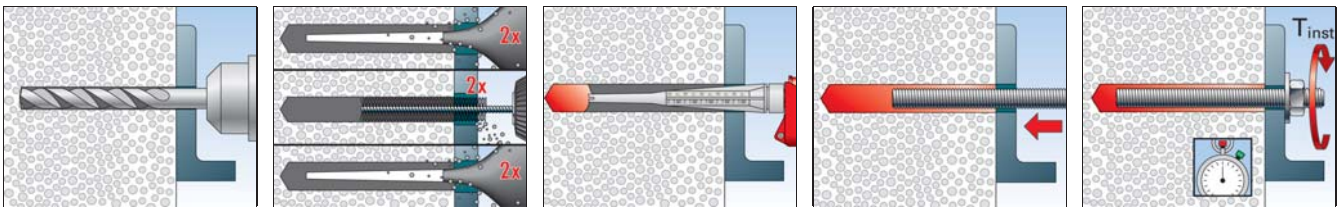

TECHNICAL DATA



FIS P Plus 300 T



FIS P Plus 380 C



Static mixer FIS MR Plus

		Approval	Languages on the cartridge	Scale unit	Contents	Sales unit
Item	Art.-No.	ETA				[pcs]
FIS P Plus 300 T	523226	■	EN, ES, PT	150	1 cartridge 300 ml, 1 x FIS MR Plus	12
FIS P Plus 300 T	537551	■	CS, SK, EL	150	1 cartridge 300 ml, 2 x FIS MR Plus	10
FIS P Plus 300 T	522430	■	DE, FR, NL	150	1 cartridge 300 ml, 2 x FIS MR Plus	12
FIS P Plus 300 T DIY	510637	■	ES, PT	150	1 cartridge 300 ml, 2 x FIS MR Plus	10
FIS P Plus 380 C	522178	■	EN, ES, PT	190	1 cartridge 380 ml, 2 x FIS MR Plus	12
FIS MR Plus	545853	—	—	—	10 static mixer FIS MR Plus	10

CURING TIME

Cartridge temperature (mortar)	Gelling time	Temperature at anchoring base	Curing time
		- 5 °C - 0 °C	24 hrs.
		+ 1 °C - + 5 °C	3 hrs.
+ 5 °C - +10 °C	9 min.	+ 6 °C - +10 °C	90 min.
+10 °C - +20 °C	5 min.	+11 °C - +20 °C	60 min.
+20 °C - +30 °C	4 min.	+21 °C - +30 °C	45 min.
+30 °C - +40 °C	2 min.	+31 °C - +40 °C	35 min.

The above times apply from the moment of contact between resin and hardener in the static mixer.

For installation, the cartridge temperature must be at least +5 °C. For longer installation times, i.e. when interruptions occur in work, the mixer should be replaced.

LOADS

Injection system FIS P Plus: Injection resin with Threaded rod FIS A

zinc plated steel 5.8 / zinc plated steel 8.8 / stainless steel A4-70 / high corrosion resistant steel C-70²⁾

Permissible loads of a single anchor in non-cracked normal concrete (concrete compression zone) of strength class C20/25 (~B25) ¹⁾³⁾⁴⁾⁵⁾										Minimum spacings while reducing the load	
Type	Material fixing element	Min. member thickness	Effective anchorage depth	Maximum torque moment	Permissible tensile load	Permissible shear load	Required edge distance (with one edge) for		Required spacing for	Min. spacing	Min. edge distance
		h_{min} [mm]	h_{ef} [mm]	T_{max} [Nm]	$N_{perm}^{6)}$ [kN]	$V_{perm}^{6)}$ [kN]	Max. tension load c [mm]	Max. shear load c [mm]	Max. Load s_{cr} [mm]		
FIS A M 8	5.8	100	60	10	4,7	5,1	75	70	180	40	40
		110	80		6,2				240		
		190	160		9,0		480				
	8.8	100	60		4,7	8,6	75	130	180		
		110	80		6,2				240		
		190	160		12,4		480				
	A4-70	100	60		4,7	6,0	55	75	180		
		110	80		6,2				240		
		190	160		9,9		480				
	C-70	100	60		4,7	7,4	75	110	180		
		110	80		6,2				240		
		190	160		12,4		480				
FIS A M 10	5.8	100	60	20	5,8	8,6	90	125	180	45	45
		120	90		8,8				270		
		230	200		13,8		600				
	8.8	100	60		5,8	11,7	90	175	180		
		120	90		8,8				270		
		230	200		19,4		600				
	A4-70	100	60		5,8	9,2	90	135	180		
		120	90		8,8				270		
		230	200		15,7		600				
	C-70	100	60		5,8	11,4	90	170	180		
		120	90		8,8				270		
		230	200		19,4		600				
FIS A M 12	5.8	100	70	40	8,2	12,0	105	175	210	55	55
		140	110		12,8				330		
		270	240		20,5		720				
	8.8	100	70		8,2	16,3	105	245	210		
		140	110		12,8				330		
		270	240		28,0		720				
	A4-70	100	70		8,2	13,7	105	200	210		
		140	110		12,8				330		
		270	240		22,5		720				
	C-70	100	70		8,2	16,3	105	245	210		
		140	110		12,8				330		
		270	240		28,0		720				
FIS A M 16	5.8	120	80	60	12,4	22,3	120	305	240	65	65
		170	125		19,4				375		
		360	320		37,6		960				
	8.8	120	80		12,4	24,9	120	345	240		
		170	125		19,4				375		
		360	320		49,8		960				
	A4-70	120	80		12,4	24,9	120	345	240		
		170	125		19,4				375		
		360	320		42,0		960				
	C-70	120	80		12,4	24,9	120	345	240		
		170	125		19,4				375		
		360	320		49,8		960				

Chemical fixings 3

LOADS

Injection system FIS P Plus: Injection resin with Threaded rod FIS A

zinc plated steel 5.8 / zinc plated steel 8.8 / stainless steel A4-70 / high corrosion resistant steel C-70²⁾

Permissible loads of a single anchor in non-cracked normal concrete (concrete compression zone) of strength class C20/25 (~B25) ¹⁾³⁾⁴⁾⁵⁾										Minimum spacings while reducing the load	
Type	Material fixing element	Min. member thickness	Effective anchorage depth	Maximum torque moment	Permissible tensile load	Permissible shear load	Required edge distance (with one edge) for		Required spacing for	Min. spacing	Min. edge distance
		h_{min} [mm]	h_{ef} [mm]	T_{max} [Nm]	$N_{perm}^{6)}$ [kN]	$V_{perm}^{6)}$ [kN]	Max. tension load c [mm]	Max. shear load c [mm]	Max. Load s_{cr} [mm]	$s_{min}^{7)}$ [mm]	$c_{min}^{7)}$ [mm]
FIS A M 20	5.8	140	90	120	16,2	32,3	135	400	270	85	85
		220	170		30,5	34,9	180	300	510		
		450	400		58,6		140	215	1200		
	8.8	140	90		16,2	32,3	135	400	270		
		220	170		30,5	56,0	180	525	510		
		450	400		71,8			320	1200		
	A4-70	140	90		16,2	32,3	135	400	270		
		220	170		30,5	39,4	180	350	510		
		450	400		65,7			160	240		
	C-70	140	90		16,2	32,3	135	400	270		
		220	170		30,5	49,1	180	455	510		
		450	400		71,8			285	1200		
FIS A M 24	5.8	160	96	150	20,7	41,4	150	490	290	105	105
		270	210		45,2	50,9	225	390	630		
		540	480		84,3		165	275	1440		
	8.8	160	96		20,7	41,4	150	490	290		
		270	210		45,2	80,6	225	675	630		
		540	480		103,4			215	420		
	A4-70	160	96		20,7	41,4	150	490	290		
		270	210		45,2	56,8	225	445	630		
		540	480		94,3			195	300		
	C-70	160	96		20,7	41,4	150	490	290		
		270	210		45,2	70,9	225	580	630		
		540	480		103,4			215	355		

For the design the complete assessment ETA-18/0383 has to be considered.⁸⁾

¹⁾ The partial safety factors for material resistance as regulated in the ETA-18/0383 as well as a partial safety factor for load actions of $\gamma_L = 1.4$ are considered. As an single anchor counts e.g. an anchor with a spacing $s \geq 3 \cdot h_{ef}$ and an edge distance $c \geq 1.5 \cdot h_{ef}$. Accurate data see ETA-18/0383

²⁾ Also valid for threaded rod RGM in the same property class.

³⁾ The given loads are valid for injection mortar for fixations in dry and humid concrete for temperatures in the substrate up to 50 °C (resp. short term up to 80 °C. For drill hole cleaning see ETA-18/0383.

⁴⁾ For higher concrete strength classes up to C50/60 higher permissible loads may be possible.

⁵⁾ Drill method hammer drilling. For further allowable application conditions see ETA-18/0383.

⁶⁾ For combinations of tensile loads and shear loads or for shear loads with lever arm (bending moments) as well as reduced edge distances or spacings (anchor groups) we recommend to use our anchor design software C-FIX.

⁷⁾ Minimum possible axial spacings resp. edge distance while reducing the permissible load.

⁸⁾ The given loads refer to the European Technical Assessment ETA-18/0383, issue date 06/09/2018. Design of the loads according ETAG 001, Technical Report TR 029 (for static resp. quasi-static loads).

LOADS

Injection system FIS P Plus with threaded rod FIS A⁴⁾

Highest permissible loads^{1) 5)} for a single anchor in solid brick masonry (without injection anchor sleeve) for pre-positioned or push-through installation.

For the design the complete assessment ETA-11/04 19 has to be considered.

Type	Compressive brick strength f_b [N/mm ²]	Brick raw density ρ [kg/dm ³]	Minimum brick dimensions ⁶⁾ (L x W x H) [mm]	Min. effective anchorage depth h_{ef} [mm]	Min. member thickness h_{min} [mm]	Maximum torque $T_{inst,max}$ [Nm]	Permissible tensile load ³⁾ N_{perm} [kN]	Permissible shear load ³⁾ V_{perm} [kN]	Characteristic spacing parallel to bed joint $s_{cr \parallel}$ [mm]	Characteristic spacing perpendicular to bed joint $s_{cr \perp}$ [mm]	Min. spacing ²⁾ $s_{min \parallel} / s_{min \perp}$ [mm]	Characteristic resp. min. edge distance ²⁾ $c_{cr} = c_{min}$ [mm]							
Solid brick Mz, NF acc. to EN 771-1																			
M8	≥10	≥1,8	240x115x71	50	115	10	1,14	0,71	150	75	150 / 75	100							
M10				50			1,00	1,14	150		150 / 75	100							
M10				80			1,43	1,14	240		240 / 75	100							
M10				200			2,43	3,40	240		240 / 75	150							
M12				50			0,86	1,14	150		150 / 75	100							
M12				80			1,51	1,14	240		240 / 75	100							
M12	200			3,20			2,43	240	240 / 75		150								
M8	≥20			≥1,8			240x115x71	50	115		10	1,57	1,14	150	75	150 / 75	100		
M10								50				1,43	1,71	150		150 / 75	100		
M10								80				2,00	1,71	240		240 / 75	100		
M10								200				2,43	2,43	240		240 / 75	150		
M12								50				1,29	1,57	150		150 / 75	100		
M12		80	2,29		1,57	240		240 / 75		100									
M12	200	2,43	2,43		240	240 / 75		150											
Solid sand-lime brick KS acc. to EN 771																			
M8	≥10	≥1,8	240x115x71		50	115		10		0,71		1,14	240	75		240 / 75	100		
M10					50					0,71		1,14					100		
M10					80					0,71		1,14					100		
M10					200					2,43		1,14					150		
M12				50	0,71		1,43		100										
M12				80	0,71		1,43		100										
M12	200			2,43	1,43		150												
M8	≥20			≥1,8	240x115x71		50		115	10	1,00	1,57			240		75	240 / 75	100
M10							50				1,00	1,57							100
M10							80				1,00	1,57							100
M10							200				2,43	1,57							150
M12							50				1,00	2,00							100
M12		80	1,00			2,00	100												
M12	200	2,43	2,00			150													

¹⁾ The required partial safety factors for material resistance as well as a partial safety factor for load actions of $\gamma_L = 1,4$ are considered.

²⁾ Minimum feasible spacings resp. edge distance. Details as well as to the distances to joints see assessment.

³⁾ For combinations of tensile loads, shear loads, bending moments as well as reduced edge distances or spacings (anchor groups) see assessment.

⁴⁾ Zinc-plated, stainless steel A4 and high corrosion-resistant steel C.

⁵⁾ The given loads are valid for installation and use of fixations in dry masonry - use category d/d - for temperatures in the substrate up to +50 °C (resp. short term up to 80 °C) and drill hole cleaning according to assessment. The given brick types in combination with the permissible loads are an extract of the assessment.

⁶⁾ Hole patterns see assessment.

LOADS

Injection system FIS P Plus with threaded rod FIS A⁵⁾ and anchor sleeve FIS H...K

Highest permissible loads^{1) 6)} for a single anchor in perforated brick masonry (with injection anchor sleeve) for pre-positioned installation. For the design the complete assessment ETA-11/04 19 has to be considered.

Type of anchor sleeve with threaded rod	Compressive brick-strength f_b [N/mm ²]	Brick raw density ρ [kg/dm ³]	Minimum brick-dimensions ⁷⁾ (L x W x H) [mm]	Min. effective anchorage depth ⁴⁾ h_{ef} [mm]	Min. member thickness h_{min} [mm]	Maximum torque $T_{inst,max}$ [Nm]	Permissible tensile load ³⁾ N_{perm} [kN]	Permissible shear load ³⁾ V_{perm} [kN]	Characteristic spacing parallel to bed joint $s_{cr \parallel}$ [mm]	Characteristic spacing perpendicular to bed joint $s_{cr \perp}$ [mm]	Min. spacing ²⁾ $s_{min \parallel} / s_{min \perp}$ [mm]	Characteristic resp. min. edge distance ²⁾ $c_{cr} = c_{min}$ [mm]
Vertically perforated brick Hz, acc. to EN 771-1												
12x85 M8	≥ 10	≥ 0,9	240x175x113	85	175	2,0	1,14	1,14	240	115	240 / 115	100
16x85 M10							1,00	1,57				
20x85 M12							1,43	1,71				
Perforated sand-lime brick KSL acc. to EN 771-2												
12x85 M8	≥ 12	≥ 1,4	240x175x113	85	175	2,0	0,71	0,71	240	115	100 / 115	100
16x85 M8/M10							0,86	1,29				
20x85 M12							1,00	1,29				
12x85 M8	≥ 20						1,29	1,29				
16x85 M8/M10							1,43	2,14				
20x85 M12							1,71	2,14				
Lightweight concrete hollow block Hbl acc. to EN 771-3												
12x85 M8	≥ 4	≥ 1,0	362x240x240	85	240	2,0	0,86	0,57	365	240	365 / 240	80
16x85 M10												
20x85 M12												

¹⁾ The required partial safety factors for material resistance as well as a partial safety factor for load actions of $\gamma_L = 1,4$ are considered.

²⁾ Minimum feasible spacings resp. edge distance. Details as well as to the distances to joints see assessment.

³⁾ For combinations of tensile loads, shear loads, bending moments as well as reduced edge distances or spacings (anchor groups) see assessment.

⁴⁾ The maximum anchorage depth is corresponding with the relevant anchor sleeves FIS H...K (see technical data).

⁵⁾ Zinc-plated, stainless steel A4 and high corrosion-resistant steel C.

⁶⁾ The given loads are valid for installation and use of fixations in dry masonry - use category d/d - for temperatures in the substrate up to +50 °C (resp. short term up to 80 °C) and drill hole cleaning according to assessment. The given brick types in combination with the permissible loads are an extract of the assessment.

⁷⁾ Hole patterns see assessment.

LOADS

Injection system FIS P Plus with threaded rod FIS A⁴⁾

Highest permissible loads^{1) 5)} for a single anchor in aerated concrete.

For the design the complete assessment ETA-11/04 19 has to be considered.

Type threaded rod	Compressive brick-strength f_b [N/mm ²]	Brick raw density ρ [kg/dm ³]	Minimum brick dimensions (L x W x H) [mm]	Min. effective anchorage depth h_{ef} [mm]	Min. member thickness h_{min} [mm]	Maximum torque $T_{inst,max}$ [Nm]	Permissible tensile load ³⁾ N_{perm} [kN]	Permissible shear load ³⁾ V_{perm} [kN]	Characteristic spacing parallel to bed joint $s_{cr \parallel}$ [mm]	Characteristic spacing perpendicular to bed joint $s_{cr \perp}$ [mm]	Min. spacing ²⁾ $s_{min \parallel} / s_{min \perp}$ [mm]	Characteristic resp. min. edge distance ²⁾ $c_{cr} = c_{min}$ [mm]
Aerated concrete acc. to EN 771-4												
M8	≥ 2	≥ 0,35					1	0,54	0,43			
M10							2	0,54	0,43			
M12							2	0,54	0,54			
M8	≥ 4	≥ 0,50		100	130		1	0,71	0,89	250	250	250
M10							2	0,89	0,71			
M12							2	0,89	0,89			
M8	≥ 6	≥ 0,65					1	1,25	1,07			
M10							2	1,79	1,07			
M12							2	1,79	1,25			

¹⁾ The required partial safety factors for material resistance as well as a partial safety factor for load actions of $\gamma_L = 1,4$ are considered.

²⁾ Minimum feasible spacings resp. edge distance. Details as well as to the distances to joints see assessment.

³⁾ For combinations of tensile loads, shear loads, bending moments as well as reduced edge distances or spacings (anchor groups) see assessment.

⁴⁾ Zinc-plated, stainless steel A4 and high corrosion-resistant steel C.

⁵⁾ The given loads are valid for installation and use of fixations in dry masonry - use category d/d - for temperatures in the substrate up to +50 °C (resp. short term up to 80 °C) and drill hole cleaning according to assessment. The given brick types in combination with the permissible loads are an extract of the assessment.

The reliable injection mortar for anchorings in masonry

Chemical fixings 3



Gates



Wall consoles

BUILDING MATERIALS

- Vertically perforated brick
- Hollow block
- Perforated sand-lime brick
- Solid sand-lime brick
- Aerated concrete
- Solid brick made from lightweight concrete
- Solid brick

ADVANTAGES

- The FIS P is the economical solution for anchorings in masonry that do not require approvals.
- The FIS P 300 T can be used with stable, standard silicone injection dispensers. No special equipment is required. This helps to reduce procurement costs.

APPLICATIONS

Injection mortar for use in masonry and aerated concrete with:

- Threaded rods FIS A, see page 144
- Internal threaded anchor FIS E, see page 161
- Injection anchor sleeves FIS H, see page 167
- Aerated concrete centring sleeve PBZ, see page 199

FUNCTIONING

- The FIS P is a 2-component injection mortar based on polyester resin.
- Resin and hardener are stored in two separate chambers and are not mixed and activated until extrusion through the static mixer.
- Partially used cartridges can be reused, simply by changing the static mixer.
- Related accessories for use in masonry and aerated concrete can be found on page 167 or page 198.

SEE ALSO



ANCHORS + SLEEVES

Page 144



DISPENSER

Page 195

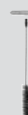

ACCESSORIES

Page 198

INSTALLATION IN SOLID BRICK WITH FIS P AND FIS A / RG M

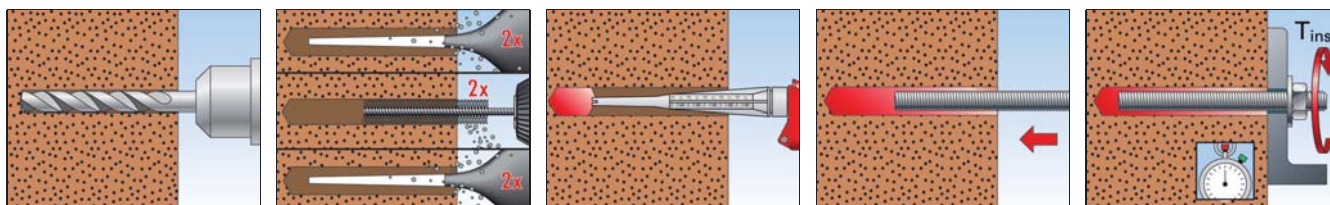

INSTALLATION IN HOLLOW BLOCKS WITH FIS P AND FIS HK + FIS A / RG M

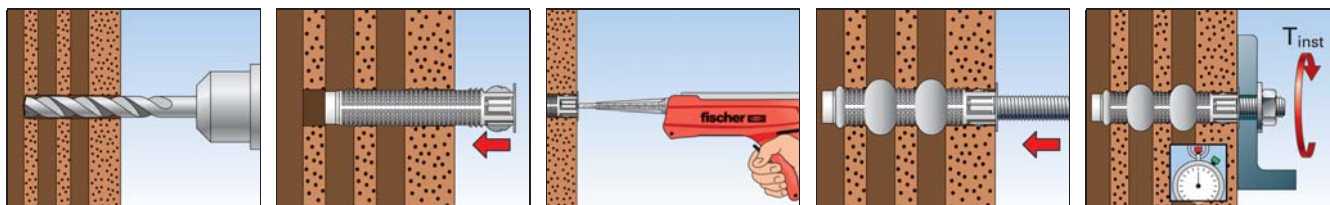

INSTALLATION IN AERATED CONCRETE WITH FIS P AND FIS A / RG M

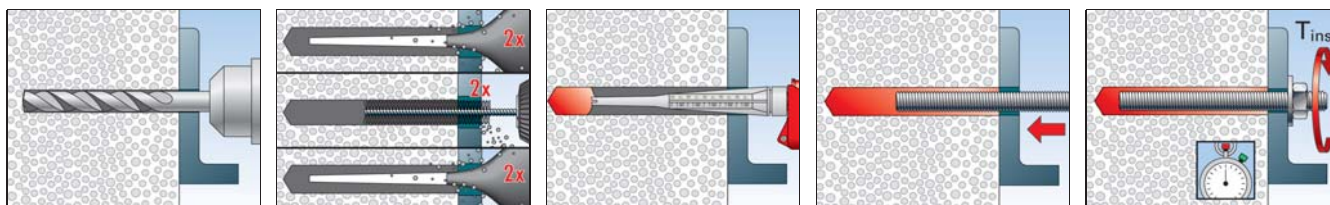

TECHNICAL DATA



FIS P 300 TB



FIS P 300 T



FIS P 360 S



FIS P 380 C



FIS P 410 C



Static mixer FIS MR Plus

Item	Art.-No.	Languages on the cartridge	Scale unit	Contents	Sales unit
					[pcs]
FIS P 300 TB	044725	DE, EN, NL, ES, ZH, PT	150	1 cartridge 300 ml, 2 x FIS MR Plus	6
FIS P 300 T	093175	DE, EN, NL, ES, ZH, PT	150	1 cartridge 300 ml, 2 x FIS MR Plus	12
FIS P 300 T	093178	PL, SL, HU, HR, RO	150	1 cartridge 300 ml, 2 x FIS MR Plus	12
FIS P 300 T	502287	LT, LV, ET, UK, RU, KK	150	1 cartridge 300 ml, 2 x FIS MR Plus	12
FIS P 300 T	051061	CS, SK, EL	150	1 cartridge 300 ml, 2 x FIS MR Plus	12
FIS P 300 T	535861	USA, RA, BR, MEX	150	1 cartridge 300 ml, 2 x FIS MR Plus	12
FIS P 300 T with Clip	537150	USA, RA, BR, MEX	150	1 cartridge 300 ml, 2 x FIS MR Plus	10
FIS P 360 S	056691	DE, FR, NL, CS, TR, PL	180	1 cartridge 360 ml, 2 x FIS MR Plus	6
FIS P 360 S	056708	GB, I, E, P, F, UAE	180	1 cartridge 360 ml, 2 x FIS MR Plus	6
FIS P 360 S	531547	USA, RA, BR, MEX	180	1 cartridge 360 ml, 2 x FIS MR Plus	12
FIS P 380 C	059234	EN, IT, PT, ES, ZH, JA	190	1 cartridge 380 ml, 2 x FIS MR Plus	12
FIS P 410 C	538134	USA, RA, BR, MEX	205	1 cartridge 410 ml, 2 x FIS MR Plus	12
FIS MR Plus	545853	-	-	10 static mixer FIS MR Plus	10



FIS P 300 T HWK small



FIS P 300 T in bucket



FIS P 380 C in bucket

		Languages on the cartridge	Contents	Sales unit
Item	Art.-No.			[pcs]
FIS P 300 T HWK small	040040	DE, EN, NL, ES, ZH, PT	12 cartridges, 24 x FIS MR Plus	1
FIS P 300 T in bucket	511341	DE, EN, NL, ES, ZH, PT	20 cartridges, 20 x FIS MR Plus	1
FIS P 380 C in bucket	511340	EN, IT, PT, ES, ZH, JA	16 cartridges, 16 x FIS MR Plus	1

CURING TIME FIS P 300 T

Cartridge temperature (mortar)	Gelling time	Temperature at anchoring base	Curing time
		± 0 °C - + 5 °C	6 hrs.
+ 5 °C - +10 °C	15 min.	+ 5 °C - +10 °C	3 hrs.
+10 °C - +20 °C	8 min.	+10 °C - +20 °C	2 hrs.
+20 °C - +30 °C	5 min.	+20 °C - +30 °C	60 min.
+30 °C - +40 °C	3 min.	+30 °C - +40 °C	30 min.

The above times apply from the moment of contact between resin and hardener in the static mixer.

For installation, the cartridge temperature must be at least +5 °C. For longer installation times, i.e. when interruptions occur in work, the mixer should be replaced.

CURING TIME FIS P 360 S

Cartridge temperature (mortar)	Gelling time	Temperature at anchoring base	Curing time
		- 5 °C	480 min.
		± 0 °C	240 min.
+ 5 °C	14 min.	+ 5 °C	120 min.
+20 °C	5 min.	+20 °C	60 min.
+30 °C	3 min.	+30 °C	30 min.
+40 °C	2 min.	+40 °C	20 min.

Please note: The curing times apply for dry anchoring bases, in damp anchoring bases they should be doubled.











CURING TIME FIS P 380 C / FIS P 410 C

Cartridge temperature (mortar)	Gelling time	Temperature at anchoring base	Curing time
		- 5 °C - ± 0 °C	6 hrs.
		± 0 °C - + 5 °C	3 hrs.
+ 5 °C - +20 °C	5 min.	+ 5 °C - +20 °C	90 min.
+20 °C - +30 °C	4 min.	+20 °C - +30 °C	45 min.
+30 °C - +40 °C	2 min.	+30 °C - +40 °C	30 min.









The above times apply from the moment of contact between resin and hardener in the static mixer.

For installation, the cartridge temperature must be at least +5 °C. For longer installation times, i.e. when interruptions occur in work, the mixer should be replaced.

Anchors and Mortars





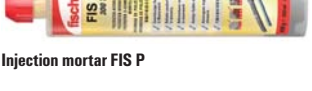





											Page
Positioning											

Mortar Cartridges





 Highbond-System FHB II	Best performance in concrete							■	■	■	■	52
 Superbond-System FSB	Concrete all-rounder	■	■	■								64
 Epoxy mortar FIS EM Plus	Powerful rebar connections + cracked concrete	■	■	■								86
 Epoxy mortar FIS EB	Basic Epoxy mortar for concrete	■	■								■	95
 Injection mortar FIS V	Versatile mortar for masonry und cracked concrete	■	■	■	■							101
 Injection mortar FIS VL	Solid mortar for standard anchorings in masonry and cracked concrete	■	■	■	■							117
 Injection mortar FIS GREEN	First approved mortar made with renewable raw materials	■	■	■	■							126
 Injection mortar FIS P Plus	Approved for Masonry	■	■		■							133
 Injection mortar FIS P	Reliable in masonry	(■)	(■)		(■)							140

■ = approved · (■) = recommendation

Anchors and Mortars

											Page
Positioning											

Mortar Capsules

 Resin capsules FHB II-P, FHB II-PF High Speed	Best performance in concrete					■						53
 Resin capsules RSB	Concrete all-rounder		■	■								73
 Resin capsules RM II	Bonded anchor for cracked concrete without drill hole cleaning		■	■								80
 UMV-P	Capsule system for dynamic loads								■			176



Bridges for traffic signs



Steel constructions

ADVANTAGES

- The system of anchor rod FIS A and an injection mortar for cracked concrete (M10 to M30) and non-cracked concrete (M6 to M30) can be individually selected based on requirements, thus allowing for a wide range of applications.
- Variable anchorage depths allow for ideal adaptation to the load to be applied, and ensure an optimised installation time and use of materials.
- Push-through installation is possible without any special parts through filling the annular gap with injection mortar.
- The wide range of approved steel types allows for use in all corrosion resistance classes and offers maximum application safety.

VERSIONS

- Zinc-plated steel
- Stainless steel

BUILDING MATERIALS

Approved for:

- Concrete C20/25 to C50/60, cracked and non-cracked

Also suitable for:

- Concrete C12/15

FUNCTIONING

- The system of threaded rod FIS A and an injection mortar for cracked concrete (M10 to M30) and non-cracked concrete (M6 to M30) can be individually selected based on requirements, thus allowing for a wide range of applications.
- The mortar is extruded bubble free from the drill hole base.
- The mortar bonds the entire surface of the threaded rod with the drill hole wall and seals the drill hole.
- The threaded rod is set manually, by lightly rotating it until it reaches the drill hole base.

Item	zinc plated, steel grade 5.8	zinc plated, steel grade 8.8	stainless steel	FIS SB		FIS EM Plus		FIS EB		FIS V		FIS VL		FIS GREEN		FIS P Plus		FIS P
	gvz Art.-No.	gvz Art.-No.	A4 Art.-No.	Concrete	Concrete	Concrete	Concrete	Masonry	Concrete	Masonry	Concrete	Masonry	Concrete	Masonry	Concrete	Masonry	Masonry	
FIS A M 6 x 70	046204								■	■	■			■				(■)
FIS A M 6 x 75	090243		090437						■	■	■			■				(■)
FIS A M 6 x 85	090272								■	■	■			■				(■)
FIS A M 6 x 110	090273		090439						■	■	■			■				(■)
FIS A M 8 x 90	090274	519390	090440	■	■	■	■	■	■	■	■	■	■	■	■	■	■	(■)
FIS A M 8 x 110	090275	519391	090441	■	■	■	■	■	■	■	■	■	■	■	■	■	■	(■)
FIS A M 8 x 130	090276	519392	090442	■	■	■	■	■	■	■	■	■	■	■	■	■	■	(■)
FIS A M 8 x 175	090277	519393	090443	■	■	■	■	■	■	■	■	■	■	■	■	■	■	(■)
FIS A M 8 x 1000	509214 ¹⁾	—	509230 ¹⁾	■	■	■	■	■	■	■	■	■	■	■	■	■	■	(■)
FIS A M 10 x 110	090278	—	090444	■	■	■	■	■	■	■	■	■	■	■	■	■	■	(■)
FIS A M 10 x 130	090279	—	090447	■	■	■	■	■	■	■	■	■	■	■	■	■	■	(■)
FIS A M 10 x 130	—	524170	—	■	■	■	■	■	■	■	■	■	■	■	■	■	■	(■)
FIS A M 10 x 150	090281	517935	090448	■	■	■	■	■	■	■	■	■	■	■	■	■	■	(■)
FIS A M 10 x 170	044969	519395	044973	■	■	■	■	■	■	■	■	■	■	■	■	■	■	(■)
FIS A M 10 x 190	—	517936	—	■	■	■	■	■	■	■	■	■	■	■	■	■	■	(■)
FIS A M 10 x 200	090282	519396	090449	■	■	■	■	■	■	■	■	■	■	■	■	■	■	(■)
FIS A M 10 x 1000	509215 ¹⁾	509223 ¹⁾	509231 ¹⁾	■	■	■	■	■	■	■	■	■	■	■	■	■	■	(■)
FIS A M 12 x 120	044971	519397	044974	■	■	■	■	■	■	■	■	■	■	■	■	■	■	(■)
FIS A M 12 x 140	090283	519398	090450	■	■	■	■	■	■	■	■	■	■	■	■	■	■	(■)
FIS A M 12 x 160	090284	517937	090451	■	■	■	■	■	■	■	■	■	■	■	■	■	■	(■)
FIS A M 12 x 180	090285	519399	090452	■	■	■	■	■	■	■	■	■	■	■	■	■	■	(■)
FIS A M 12 x 200	—	517938	519421	■	■	■	■	■	■	■	■	■	■	■	■	■	■	(■)
FIS A M 12 x 210	090286	—	090453	■	■	■	■	■	■	■	■	■	■	■	■	■	■	(■)
FIS A M 12 x 260	090287	—	090454	■	■	■	■	■	■	■	■	■	■	■	■	■	■	(■)
FIS A M 12 x 1000	509216 ¹⁾	509224 ¹⁾	509232 ¹⁾	■	■	■	■	■	■	■	■	■	■	■	■	■	■	(■)
FIS A M 16 x 130	044972	519400	044975	■	■	■	■	■	■	■	■	■	■	■	■	■	■	
FIS A M 16 x 175	090288	519401	090455	■	■	■	■	■	■	■	■	■	■	■	■	■	■	
FIS A M 16 x 200	090289	517939	090456	■	■	■	■	■	■	■	■	■	■	■	■	■	■	
FIS A M 16 x 250	090290	517940	090457	■	■	■	■	■	■	■	■	■	■	■	■	■	■	
FIS A M 16 x 300	090291	519402	090458	■	■	■	■	■	■	■	■	■	■	■	■	■	■	
FIS A M 16 x 1000	509217 ¹⁾	509225 ¹⁾	509233 ¹⁾	■	■	■	■	■	■	■	■	■	■	■	■	■	■	
FIS A M 20 x 245	090292	519404	090459	■	■	■	■	■	■	■	■	■	■	■	■	■	■	
FIS A M 20 x 290	090293	519406	090460	■	■	■	■	■	■	■	■	■	■	■	■	■	■	
FIS A M 20 x 1000	—	519410 ¹⁾	519427 ¹⁾	■	■	■	■	■	■	■	■	■	■	■	■	■	■	
FIS A M 24 x 290	090294	—	090461	■	■	■	■	■	■	■	■	■	■	■	■	■	■	
FIS A M 24 x 380	090295	—	090462	■	■	■	■	■	■	■	■	■	■	■	■	■	■	
FIS A M 24 x 1000	533881	—	—	■	■	■	■	■	■	■	■	■	■	■	■	■	■	
FIS A M 30 x 430	090297	—	090464	■	■	■	■	■	■	■	■	■	■	■	■	■	■	

■ = approved · (■) = recommendation

TECHNICAL DATA IN CONCRETE



Threaded rod FIS A

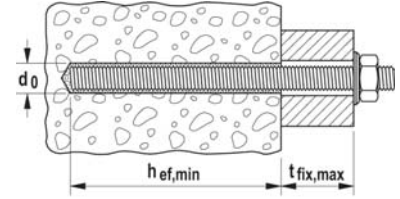

3
Chemical fixings

Item	Zinc plated, steel grade 5.8	Zinc plated, steel grade 8.8	Stainless steel	Approval		Drill hole diameter d_0 [mm]	Min. / max. anchorage depth [mm]	Min. / max. usable length [mm]	Min. / max. filling quantity [scale units]	Sales unit [pcs]
	Art.-No.	Art.-No.	Art.-No.	ETA	ICC					
	gvz	gvz	A4							
FIS A M 6 x 70	046204	—	—	■	—	8	50 / 61	1 / 12	2	10
FIS A M 6 x 75	090243	—	090437	■	—	8	50 / 66	1 / 17	2	20
FIS A M 6 x 85	090272	—	—	■	—	8	50 / 72	5 / 27	2	20
FIS A M 6 x 110	090273	—	090439	■	—	8	50 / 72	30 / 52	2	20
FIS A M 8 x 90	090274	519390	090440	■	▲	10	60 / 78	1 / 19	2 / 3	10
FIS A M 8 x 110	090275	519391	090441	■	▲	10	60 / 98	1 / 39	2 / 3	10
FIS A M 8 x 130	090276	519392	090442	■	▲	10	60 / 118	1 / 59	2 / 4	10
FIS A M 8 x 175	090277	519393	090443	■	▲	10	60 / 160	4 / 104	2 / 5	10
FIS A M 8 x 1000	509214 ¹⁾	—	509230 ¹⁾	■	▲	10	60 / 160	—	2 / 5	10
FIS A M 8 x 1000	—	509222 ¹⁾	—	■	—	10	60 / 160	—	2 / 5	10
FIS A M 10 x 110	090278	—	090444	■	▲	12	60 / 96	1 / 37	3 / 4	10
FIS A M 10 x 130	090279	524170	090447	■	▲	12	60 / 116	1 / 57	3 / 5	10
FIS A M 10 x 150	090281	517935	090448	■	▲	12	60 / 136	1 / 77	3 / 5	10
FIS A M 10 x 170	044969	519395	044973	■	▲	12	60 / 156	1 / 97	3 / 6	10
FIS A M 10 x 190	—	517936	—	■	▲	12	60 / 176	1 / 117	3 / 7	10
FIS A M 10 x 200	090282	519396	090449	■	▲	12	60 / 186	1 / 127	3 / 7	10
FIS A M 10 x 1000	509215 ¹⁾	509223 ¹⁾	509231 ¹⁾	■	▲	12	60 / 200	—	3 / 7	10
FIS A M 12 x 120	044971	519397	044974	■	▲	14	70 / 103	1 / 34	3 / 5	10
FIS A M 12 x 140	090283	519398	090450	■	▲	14	70 / 123	1 / 54	3 / 6	10
FIS A M 12 x 160	090284	517937	090451	■	▲	14	70 / 143	1 / 74	3 / 7	10
FIS A M 12 x 180	090285	519399	090452	■	▲	14	70 / 163	1 / 94	3 / 7	10
FIS A M 12 x 200	—	517938	—	■	▲	14	70 / 183	1 / 114	3 / 8	10
FIS A M 12 x 210	090286	—	090453	■	▲	14	70 / 193	1 / 124	3 / 9	10
FIS A M 12 x 260	090287	—	090454	■	▲	14	70 / 240	4 / 174	3 / 10	10
FIS A M 12 x 1000	509216 ¹⁾	509224 ¹⁾	509232 ¹⁾	■	▲	14	70 / 240	—	3 / 10	10
FIS A M 16 x 130	044972	519400	044975	■	▲	18	80 / 109	1 / 30	5 / 7	10
FIS A M 16 x 175	090288	519401	090455	■	▲	18	80 / 154	1 / 75	5 / 10	10
FIS A M 16 x 200	090289	517939	090456	■	▲	18	80 / 179	1 / 100	5 / 11	10
FIS A M 16 x 250	090290	517940	090457	■	▲	18	80 / 229	1 / 150	5 / 14	10
FIS A M 16 x 300	090291	519402	090458	■	▲	18	80 / 279	1 / 200	5 / 17	10
FIS A M 16 x 1000	509217 ¹⁾	509225 ¹⁾	509233 ¹⁾	■	▲	18	80 / 320	—	5 / 19	10
FIS A M 20 x 245	090292	519404	090459	■	▲	24	90 / 220	1 / 131	11/28	10
FIS A M 20 x 290	090293	519406	090460	■	▲	24	90 / 265	1 / 176	11/32	10
FIS A M 20 x 1000	—	519410 ¹⁾	519427 ¹⁾	■	▲	24	90 / 400	—	11/48	10
FIS A M 24 x 290	090294	—	090461	■	▲	28	96 / 260	1 / 165	15/69	5
FIS A M 24 x 380	090295	—	090462	■	▲	28	96 / 350	1 / 255	15/52	5
FIS A M 24 x 1000	533881	—	—	■	▲	28	96 / 480	—	15/69	10
FIS A M 30 x 430	090297	—	090464	■	▲	35	120 / 394	1 / 275	28/88	5

¹⁾ Order washer and nut separately.

FIS A M 6 x ... : ETA-Approval in combination with FIS V, FIS VW, FIS VS

TECHNICAL DATA IN SOLID BRICK MASONRY



Threaded rod FIS A

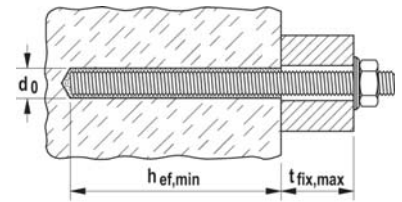

	Zinc plated, steel grade 5.8	Zinc plated, steel grade 8.8	Stainless steel	Approval	Drill hole diameter	Min. effective anchorage depth acc. ETA	Max. effective length acc. ETA	Fill quantity for effect. anchoring depth	Sales unit
	Art.-No.	Art.-No.	Art.-No.	ETA	d_0 [mm]	[mm]	[mm]	[scale units]	[pcs]
Item	gvz	gvz	A4						
FIS A M 6 x 70	046204	—	—	■	8	50	11	2	10
FIS A M 6 x 75	090243	—	090437	■	8	50	17	2	20
FIS A M 6 x 85	090272	—	—	■	8	50	27	2	20
FIS A M 6 x 110	090273	—	090439	■	8	50	50	2	20
FIS A M 8 x 90	090274	519390	090440	■	10	50	29	2	10
FIS A M 8 x 110	090275	519391	090441	■	10	50	46	2	10
FIS A M 8 x 130	090276	519392	090442	■	10	50	66	2	10
FIS A M 8 x 175	090277	519393	090443	■	10	50	111	2	10
FIS A M 10 x 110	090278	—	090444	■	12	50	30	3	10
FIS A M 10 x 130	090279	524170	090447	■	12	50	50	3	10
FIS A M 10 x 150	090281	517935	090448	■	12	50	70	3	10
FIS A M 10 x 170	044969	519395	044973	■	12	50	90	3	10
FIS A M 10 x 190	—	517936	—	■	12	50	110	3	10
FIS A M 10 x 200	090282	519396	090449	■	12	50	120	3	10
FIS A M 12 x 120	044971	519397	044974	■	14	50	39	3	10
FIS A M 12 x 140	090283	519398	090450	■	14	50	59	3	10
FIS A M 12 x 160	090284	517937	090451	■	14	50	79	3	10
FIS A M 12 x 180	090285	519399	090452	■	14	50	99	3	10
FIS A M 12 x 200	—	517938	—	■	14	50	119	3	10
FIS A M 12 x 210	090286	—	090453	■	14	50	129	3	10
FIS A M 12 x 260	090287	—	090454	■	14	50	179	3	10
FIS A M 16 x 130	044972	519400	044975	■	18	50	20	6	10
FIS A M 16 x 175	090288	519401	090455	■	18	50	65	6	10
FIS A M 16 x 200	090289	517939	090456	■	18	50	90	6	10
FIS A M 16 x 250	090290	517940	090457	■	18	50	140	6	10
FIS A M 16 x 300	090291	519402	090458	■	18	50	190	6	10

FIS A M 6 x ... : ETA-Approval in combination with FIS V, FIS VW, FIS VS

TECHNICAL DATA IN PERFORATED BRICK MASONRY



Threaded rod FIS A

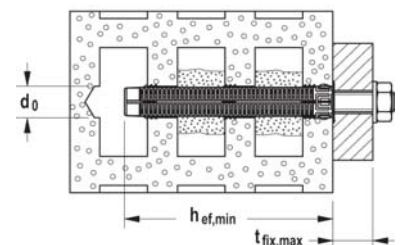

	Zinc plated, steel grade 5.8	Zinc plated, steel grade 8.8	Stainless steel	Approval	Drill hole diameter in perforated brick masonry	Min. anchorage depth in perforated brick masonry	Max. useful length in perforated brick masonry	Suitable injection anchor sleeve	Sales unit
	Art.-No.	Art.-No.	Art.-No.	ETA	d_0 [mm]	$h_{ef, min}$ [mm]	$t_{fix, max}$ [mm]		[pcs]
Item	gvz	gvz	A4						
FIS A M 6 x 70	046204	—	—	■	12	50	11	FIS H 12 x 50 K	10
FIS A M 6 x 75	090243	—	090437	■	12	50	16	FIS H 12 x 50 K	20
FIS A M 6 x 85	090272	—	—	■	12	50	26	FIS H 12 x 50 K	20

TECHNICAL DATA IN PERFORATED BRICK MASONRY



Threaded rod FIS A

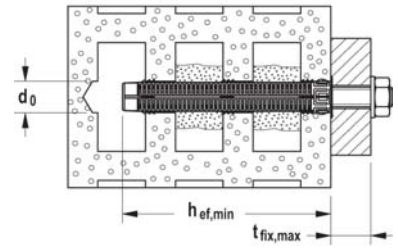

Chemical fixings 3

Item	Zinc plated, steel grade 5.8	Zinc plated, steel grade 8.8	Stainless steel	Approval ETA	Drill hole diameter in perforated brick masonry d_0 [mm]	Min. anchorage depth in perfora- ted brick masonry $h_{ef,min}$ [mm]	Max. useful length in perforated brick masonry $t_{fix,max}$ [mm]	Suitable injection anchor sleeve	Sales unit
	Art.-No.	Art.-No.	Art.-No.						[pcs]
	gvz	gvz	A4						
FIS A M 6 x 110	090273	—	090439	■	12	50 85	52 17	FIS H 12 x 50 K FIS H 12 x 85 K	20
FIS A M 8 x 90	090274	519390	090440	■	12	50	29	FIS H 12 x 50 K	10
FIS A M 8 x 110	090275	519391	090441	■	12	50	49	FIS H 12 x 50 K	10
					12	85	14	FIS H 12 x 85 K	
					16	85	14	FIS H 16 x 85 K	
FIS A M 8 x 130	090276	519392	090442	■	12/16	50	69	FIS H 12 x 50 K	10
						85	34	FIS H 12 x 85 K	
						85	34	FIS H 16 x 85 K	
FIS A M 8 x 175	090277	519393	090443	■	12	50	114	FIS H 12 x 50 K	10
					12	85	79	FIS H 12 x 85 K	
					12	85	79	FIS H 16 x 85 K	
					16	130	34	FIS H 16 x 130 K	
FIS A M 10 x 110	090278	—	090444	■	16	85	12	FIS H 16 x 85 K	10
FIS A M 10 x 130	090279	524170	090447	■	16	85	32	FIS H 16 x 85 K	10
FIS A M 10 x 150	090281	517935	090448	■	16	85	52	FIS H 16 x 85 K	10
						130	7	FIS H 16 x 130 K	
FIS A M 10 x 170	044969	519395	044973	■	16	85	72	FIS H 16 x 85 K	10
						130	27	FIS H 16 x 130 K	
FIS A M 10 x 190	—	517936	—	■	16	85	92	FIS H 16 x 85 K	10
						130	47	FIS H 16 x 130 K	
FIS A M 10 x 200	090282	519396	090449	■	16	85	102	FIS H 16 x 85 K	10
						130	57	FIS H 16 x 130 K	
FIS A M 12 x 120	044971	519397	044974	■	20	85	19	FIS H 20 x 85 K	10
FIS A M 12 x 140	090283	519398	090450	■	20	85	39	FIS H 20 x 85 K	10
FIS A M 12 x 160	090284	517937	090451	■	20	85	59	FIS H 20 x 85 K	10
						130	14	FIS H 20 x 130 K	
FIS A M 12 x 180	090285	519399	090452	■	20	85	79	FIS H 20 x 85 K	10
						130	34	FIS H 20 x 130 K	
FIS A M 12 x 200	—	517938	—	■	20	85	99	FIS H 20 x 85 K	10
						130	54	FIS H 20 x 130 K	
FIS A M 12 x 210	090286	—	090453	■	20	85	109	FIS H 20 x 85 K	10
						130	64	FIS H 20 x 130 K	
FIS A M 12 x 260	090287	—	090454	■	20	85	169	FIS H 20 x 85 K	10
						130	114	FIS H 20 x 130 K	
						200	44	FIS H 20 x 200 K	
FIS A M 16 x 130	044972	519400	044975	■	20	85	25	FIS H 20 x 85 K	10
FIS A M 16 x 175	090288	519401	090455	■	20	85	70	FIS H 20 x 85 K	10
						130	25	FIS H 20 x 130 K	
FIS A M 16 x 200	090289	517939	090456	■	20	85	95	FIS H 20 x 85 K	10
						130	50	FIS H 20 x 130 K	
FIS A M 16 x 250	090290	517940	090457	■	20	85	145	FIS H 20 x 85 K	10
						130	100	FIS H 20 x 130 K	
						200	30	FIS H 20 x 200 K	
FIS A M 16 x 300	090291	519402	090458	■	20	85	195	FIS H 20 x 85 K	10
						130	150	FIS H 20 x 130 K	
						200	80	FIS H 20 x 200 K	

TECHNICAL DATA IN UNDERCUT DRILL HOLE IN AERATED CONCRETE



Threaded rod FIS A

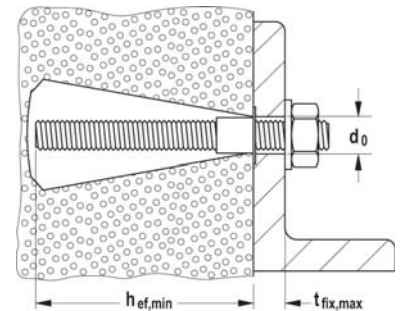

Item	Zinc plated, steel grade 5.8	Zinc plated, steel grade 8.8	Stainless steel	Approval ETA	Drill hole diameter in aerated concrete in undercut drill hole	Min. / max. anchorage depth in aerated concrete in undercut drill hole	Min. / max. usable length in aerated concrete	Filling quantity for min. / max. anchorage depth in aerated concrete	Sales unit
	Art.-No.	Art.-No.	Art.-No.		[mm]	h_{ef} [mm]	t_{fix} [mm]	[scale units]	[pcs]
	gvz	gvz	A4						
FIS A M 8 x 90	090274	519390	090440	■	14	75 / 95	4 / -	15 / 20	10
FIS A M 8 x 110	090275	519391	090441	■	14	75 / 95	24 / 4	15 / 20	10
FIS A M 8 x 130	090276	519392	090442	■	14	75 / 95	44 / 24	15 / 20	10
FIS A M 8 x 175	090277	519393	090443	■	14	75 / 95	89 / 69	15 / 20	10
FIS A M 10 x 110	090278	—	090444	■	14	75 / 95	22 / 2	15 / 20	10
FIS A M 10 x 130	090279	524170	090447	■	14	75 / 95	42 / 22	15 / 20	10
FIS A M 10 x 150	090281	517935	090448	■	14	75 / 95	62 / 42	15 / 20	10
FIS A M 10 x 170	044969	519395	044973	■	14	75 / 95	82 / 62	15 / 20	10
FIS A M 10 x 190	—	517936	—	■	14	75 / 95	102 / 82	15 / 20	10
FIS A M 10 x 200	090282	519396	090449	■	14	75 / 95	112 / 92	15 / 20	10
FIS A M 12 x 120	044971	519397	044974	■	14	75 / 95	29 / 9	15 / 20	10
FIS A M 12 x 140	090283	519398	090450	■	14	75 / 95	49 / 29	15 / 20	10
FIS A M 12 x 160	090284	517937	090451	■	14	75 / 95	69 / 49	15 / 20	10
FIS A M 12 x 180	090285	519399	090452	■	14	75 / 95	89 / 69	15 / 20	10
FIS A M 12 x 200	—	517938	—	■	14	75 / 95	109 / 89	15 / 20	10
FIS A M 12 x 210	090286	—	090453	■	14	75 / 95	119 / 99	15 / 20	10
FIS A M 12 x 260	090287	—	090454	■	14	75 / 95	169 / 149	15 / 20	10

TECHNICAL DATA IN AERATED CONCRETE



Threaded rod FIS A

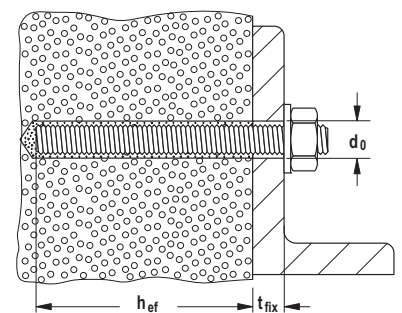

Item	Zinc plated, steel grade 5.8	Zinc plated, steel grade 8.8	Stainless steel	Approval ETA	Drill hole diameter in aerated concrete in cylindrical drill hole	Anchorage depth in aerated concrete in cylindrical drill hole	Usable length	Fill quantity for effect, anchorage depth in aerated concrete	Sales unit
	Art.-No.	Art.-No.	Art.-No.		d_0 [mm]	h_{ef} [mm]	t_{fix} [mm]	[scale units]	[pcs]
	gvz	gvz	A4						
FIS A M 8 x 90	—	—	090440	■	10	100	—	—	10
FIS A M 8 x 110	090275	519391	090441	■	10	100	2	—	10
FIS A M 8 x 130	090276	519392	090442	■	10	100	19	3	10
FIS A M 8 x 175	090277	519393	090443	■	10	100	64	3	10
FIS A M 10 x 110	090278	—	090444	■	12	100	—	—	10
FIS A M 10 x 130	090279	524170	090447	■	12	100	17	6	10
FIS A M 10 x 150	090281	517935	090448	■	12	100	37	4	10

TECHNICAL DATA IN AERATED CONCRETE



Threaded rod FIS A

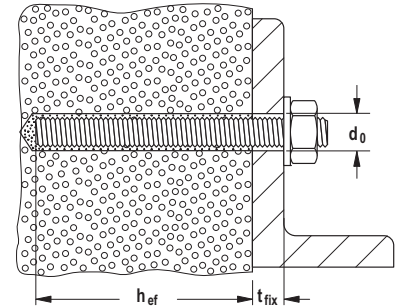

3
Chemical fixings

Item	Zinc plated, steel grade 5.8	Zinc plated, steel grade 8.8	Stainless steel	Approval ETA	Drill hole diameter in aerated concrete in cylindrical drill hole	Anchorage depth in aerated concrete in cylindrical drill hole	Usable length	Fill quantity for effect. anchorage depth in aerated concrete	Sales unit
	Art.-No.	Art.-No.	Art.-No.		d_0 [mm]	h_{ef} [mm]	t_{fix} [mm]	[scale units]	[pcs]
	gvz	gvz	A4						
FIS A M 10 x 170	044969	519395	044973	■	12	100	57	4	10
FIS A M 10 x 190	—	517936	—	■	12	100	77	4	10
FIS A M 10 x 200	090282	519396	090449	■	12	100	87	4	10
FIS A M 12 x 120	044971	519397	044974	■	14	100	4	5	10
FIS A M 12 x 140	090283	519398	090450	■	14	100	24	5	10
FIS A M 12 x 160	090284	517937	090451	■	14	100	44	5	10
FIS A M 12 x 180	090285	519399	090452	■	14	100	64	5	10
FIS A M 12 x 200	—	517938	—	■	14	100	84	5	10
FIS A M 12 x 210	090286	—	090453	■	14	100	94	5	10
FIS A M 12 x 260	090287	—	090454	■	14	100	144	5	10
FIS A M 16 x 130	044972	519400	044975	■	18	100	10	6	10
FIS A M 16 x 175	090288	519401	090455	■	18	100	55	6	10
FIS A M 16 x 200	090289	517939	090456	■	18	100	80	6	10
FIS A M 16 x 250	090290	517940	090457	■	18	100	130	6	10
FIS A M 16 x 300	090291	519402	090458	■	18	100	180	6	10

TECHNICAL DATA



Hexagonal nut and washer

Item	Zinc plated, steel grade 8.8	Stainless steel	Width across nut	Washer (outer diameter x thickness)	Match	Sales unit
	Art.-No.	Art.-No.	○SW [mm]	[mm]		[pcs]
	gvz	A4				
Nut & washer M8	510509	—	13	16 x 1,6	FIS A M8	50
Nut & washer M10	510510	—	17	20 x 2	FIS A M10	50
Nut & washer M12	510511	—	19	24 x 2,5	FIS A M12	25
Nut & washer M16	510512	—	24	30 x 3	FIS A M16	20
Nut & washer M8	—	510513	13	16 x 1,6	FIS A M8 A4	50
Nut & washer M10	—	510514	17	20 x 2	FIS A M10 A4	50
Nut & washer M12	—	510515	19	24 x 2,5	FIS A M12 A4	25
Nut & washer M16	—	510516	24	30 x 3	FIS A M16 A4	20
Nut & washer M20	—	519738	30	37 x 3	FIS A M20 A4	10
Nut & washer M20	519737	—	30	37 x 3	FIS A M 20	10

TECHNICAL DATA



Filling Sets for subsequent filling of the annular gap

Item	Art.-No.	For use with injection mortar	Match	Sales unit [pcs]
Filling Set M12	537218	FIS SB, FIS EM Plus, FIS V	FIS A M12	10
Filling Set M16	537219	FIS SB, FIS EM Plus, FIS V	FIS A M16	10
Filling Set M20	537220	FIS SB, FIS EM Plus, FIS V	FIS A M 20	10



Steel constructions

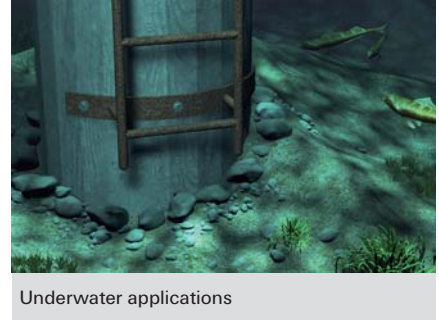

Underwater applications

ADVANTAGES

- The wide range of the RG M from M8 to M30 opens up a wide range of applications and therefore offers great flexibility.
- The wide range of approved steel types for RG M allows for use in all corrosion resistance classes and offers the best possible application safety.
- Please refer to the approvals for the resin capsules and mortar used.

VERSIONS

- Zinc-plated steel
- Stainless steel

BUILDING MATERIALS

Approved for anchorings in:











- Concrete C20/25 to C50/60, cracked and non-cracked

Also suitable for:

- Natural stone with dense structure

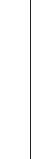
FUNCTIONING

- Due to its oblique edge, the threaded rod RG M is particularly suitable for use in conjunction with resin capsules.
- The threaded rod RG M is set using a hammer drill and the accompanying setting tool in rotating and hitting motions.
- During setting, the oblique edge of the RG M destroys the capsule, and mixes and activates the mortar.
- Use with injection mortar is also possible. Here, the threaded rod is manually inserted into the drill hole with a light rotating movement until it reaches the base of the hole.

Item																									
	zinc plated, steel grade 5.8	zinc plated, steel grade 8.8	stainless steel	hot-dip galvanized steel	highly corrosion resistant steel	FIS SB	FIS EM Plus	FIS EB	FIS V	FIS VL	FIS GREEN	FIS P Plus	FIS P	RSB	RM II										
	gvz Art.-No.	gvz Art.-No.	A4 Art.-No.	hdg Art.-No.	C Art.-No.	Concrete	Concrete	Concrete	Concrete	Masonry	Concrete	Masonry	Concrete	Masonry	Masonry	Concrete	Concrete								
RG M 8 x 110	050256	—	050263			■	■	■	■	■	■	■	■	■	■	■	■	■	■	■	■	■	■		
RG M 8 x 150	095698	519443	050293			■	■	■	■	■	■	■	■	■	■	■	■	■	■	■	■	■	■		
RG M 10 x 110	535007	—	535009			■	■	■	■	■	■	■	■	■	■	■	■	■	■	■	■	■	■		
RG M 10 x 130	050257	—	050264		096217 ¹⁾	■	■	■	■	■	■	■	■	■	■	■	■	■	■	■	■	■	■		
RG M 10 x 165	050280	—	050294			■	■	■	■	■	■	■	■	■	■	■	■	■	■	■	■	■	■		
RG M 10 x 190	050281	—	050296			■	■	■	■	■	■	■	■	■	■	■	■	■	■	■	■	■	■		
RG M 10 x 220	—	519444	—			■	■	■	■	■	■	■	■	■	■	■	■	■	■	■	■	■	■		
RG M 10 x 250	095703	—	095701			■	■	■	■	■	■	■	■	■	■	■	■	■	■	■	■	■	■		
RG M 10 x 350	095718	—	095709			■	■	■	■	■	■	■	■	■	■	■	■	■	■	■	■	■	■		
RG M 12 x 120	535010	—	535011			■	■	■	■	■	■	■	■	■	■	■	■	■	■	■	■	■	■		
RG M 12 x 160	050258	—	050265	512247	096218 ¹⁾	■	■	■	■	■	■	■	■	■	■	■	■	■	■	■	■	■	■		
RG M 12 x 180	512248	—	512249			■	■	■	■	■	■	■	■	■	■	■	■	■	■	■	■	■	■		
RG M 12 x 200	—	—	050576			■	■	■	■	■	■	■	■	■	■	■	■	■	■	■	■	■	■		
RG M 12 x 220	050283	519445	050297			■	■	■	■	■	■	■	■	■	■	■	■	■	■	■	■	■	■		
RG M 12 x 250	050284	—	095702			■	■	■	■	■	■	■	■	■	■	■	■	■	■	■	■	■	■		
RG M 12 x 300	050285	—	095705			■	■	■	■	■	■	■	■	■	■	■	■	■	■	■	■	■	■		
RG M 12 x 380	095720 ²⁾	—	095710 ¹⁾			■	■	■	■	■	■	■	■	■	■	■	■	■	■	■	■	■	■		
RG M 16 x 165	050287	—	095704	537062		■	■	■	■	■	■	■	■	■	■	■	■	■	■	■	■	■	■		
RG M 16 x 140	542407	—	—			■	■	■	■	■	■	■	■	■	■	■	■	■	■	■	■	■	■		
RG M 16 x 190	050259	—	050266	512250	096219 ¹⁾	■	■	■	■	■	■	■	■	■	■	■	■	■	■	■	■	■	■		
RG M 16 x 250	050288	—	050298			■	■	■	■	■	■	■	■	■	■	■	■	■	■	■	■	■	■		
RG M 16 x 270	—	519446	—			■	■	■	■	■	■	■	■	■	■	■	■	■	■	■	■	■	■		
RG M 16 x 300	050289	—	050299			■	■	■	■	■	■	■	■	■	■	■	■	■	■	■	■	■	■		
RG M 16 x 380	095722 ²⁾	—	095712 ¹⁾			■	■	■	■	■	■	■	■	■	■	■	■	■	■	■	■	■	■		
RG M 16 x 500	095723 ²⁾	—	095713 ¹⁾			■	■	■	■	■	■	■	■	■	■	■	■	■	■	■	■	■	■		
RG M 20 x 220	512251	—	—			■	■	■	■	■	■	■	■	■	■	■	■	■	■	■	■	■	■		
RG M 20 x 260	050260	—	050267			■	■	■	■	■	■	■	■	■	■	■	■	■	■	■	■	■	■		
RG M 20 x 290	—	519447	—			■	■	■	■	■	■	■	■	■	■	■	■	■	■	■	■	■	■		
RG M 20 x 350	095707	—	095706			■	■	■	■	■	■	■	■	■	■	■	■	■	■	■	■	■	■		
RG M 20 x 500	095725 ¹⁾	—	—			■	■	■	■	■	■	■	■	■	■	■	■	■	■	■	■	■	■		
RG M 24 x 295	—	519448 ¹⁾	—			■	■	■	■	■	■	■	■	■	■	■	■	■	■	■	■	■	■		
RG M 24 x 300	050261 ¹⁾	—	050268 ¹⁾			■	■	■	■	■	■	■	■	■	■	■	■	■	■	■	■	■	■		
RG M 24 x 400	095727 ¹⁾	—	095715 ¹⁾			■	■	■	■	■	■	■	■	■	■	■	■	■	■	■	■	■	■		
RG M 24 x 600	095728	—	—			■	■	■	■	■	■	■	■	■	■	■	■	■	■	■	■	■	■		
RG M 30 x 380	050262 ¹⁾	—	090726 ¹⁾			■	■	■	■	■	■	■	■	■	■	■	■	■	■	■	■	■	■		
RG M 30 x 500	095730 ¹⁾	—	—			■	■	■	■	■	■	■	■	■	■	■	■	■	■	■	■	■	■		

■ = approved
 (■) = recommendation

TECHNICAL DATA IN CONCRETE



Threaded rod **RG M**

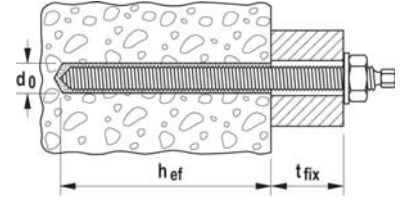

3
Chemical fixings

Item	Zinc plated, steel grade 5.8	Zinc plated, steel grade 8.8	Stainless steel	Approval		Drill hole diameter d_0 [mm]	Anchorage depth (short/standard/large) h_{ef} [mm]	Usable length (short/standard/large) t_{fix} [mm]	Fits capsule RSB	Sales unit [pcs]
	Art.-No.	Art.-No.	Art.-No.	ETA	ICC					
	gvz	gvz	A4							
RG M 8 x 110	050256	—	050263	■	—	10	- / 80 / -	- / 14 / -	1 x RSB 8	10
RG M 8 x 150	095698	—	050293	■	—	10	- / 80 / -	- / 54 / -	1 x RSB 8	10
RG M 8 x 150	—	519443	—	—	—	10	- / 80 / -	- / 54 / -	1 x RSB 8	10
RG M 10 x 110	535007	—	535009	—	—	12	75 / - / -	15 / - / -	1 x RSB 10 Mini	10
RG M 10 x 130	050257	—	050264	■	—	12	75 / 90 / -	35 / 20 / -	1 x RSB 10 mini 1 x RSB 10	10
RG M 10 x 165	050280	—	050294	■	—	12	75 / 90 / -	70 / 55 / -	1 x RSB 10 mini 1 x RSB 10	10
RG M 10 x 190	050281	—	050296	■	—	12	75 / 90 / 150	95 / 80 / 20	1 x RSB 10 mini 1 x RSB 10 2 x RSB 10 mini	10
RG M 10 x 220	—	519444	—	—	—	12	75 / 90 / 150	125 / 110 / 50	1 x RSB 10 mini 1 x RSB 10 2 x RSB 10 mini	10
RG M 10 x 250	095703	—	095701	■	—	12	75 / 90 / 150	155 / 140 / 80	1 x RSB 10 mini 1 x RSB 10 2 x RSB 10 mini	10
RG M 10 x 350	—	—	095709	—	—	12	75 / 90 / 150	255 / 240 / 180	1 x RSB 10 mini 1 x RSB 10 2 x RSB 10 mini	10
RG M 10 x 350	095718	—	—	■	—	12	75 / 90 / 150	255 / 240 / 180	1 x RSB 10 mini 1 x RSB 10 2 x RSB 10 mini	10
RG M 12 x 120	535010	—	535011	■	—	14	75 / - / -	21 / - / -	1 x RSB 12 mini	10
RG M 12 x 160	050258	—	050265	■	—	14	75 / 110 / -	61 / 26 / -	1 x RSB 12 mini 1 x RSB 12	10
RG M 12 x 180	512248	—	512249	■	—	14	75 / 110 / 150	81 / 46 / 6	1 x RSB 12 mini 1 x RSB 12 2 x RSB 12 mini	10
RG M 12 x 200	—	—	050576	■	—	14	75 / 110 / 150	101 / 66 / 26	1 x RSB 12 mini 1 x RSB 12 2 x RSB 12 mini	10
RG M 12 x 220	—	519445	—	—	—	14	75 / 110 / 150	121 / 86 / 46	1 x RSB 12 mini 1 x RSB 12 2 x RSB 12 mini	10
RG M 12 x 220	050283	—	050297	■	—	14	75 / 110 / 150	121 / 86 / 46	1 x RSB 12 mini 1 x RSB 12 2 x RSB 12 mini	10
RG M 12 x 250	050284	—	095702	■	—	14	75 / 110 / 150	151 / 116 / 76	1 x RSB 12 mini 1 x RSB 12 2 x RSB 12 mini	10
RG M 12 x 300	050285	—	095705	■	—	14	75 / 110 / 150	201 / 166 / 126	1 x RSB 12 mini 1 x RSB 12 2 x RSB 12 mini	10
RG M 12 x 380	095720 2)	—	095710 1)	■	—	14	75 / 110 / 150	281 / 246 / 206	1 x RSB 12 mini 1 x RSB 12 2 x RSB 12 mini	10

1) Straight cut, additional setting tool required

2) Straight cut, setting tool is enclosed.

TECHNICAL DATA IN CONCRETE



Threaded rod **RG M**

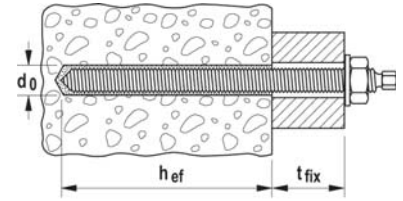

Item	Zinc plated, steel grade 5.8	Zinc plated, steel grade 8.8	Stainless steel	Approval		Drill hole diameter d_0 [mm]	Anchorage depth (short/standard/large) h_{ef} [mm]	Usable length (short/standard/large) t_{fix} [mm]	Fits capsule RSB	Sales unit [pcs]
	Art.-No.	Art.-No.	Art.-No.	ETA	ICC					
	gvz	gvz	A4							
RG M 16 x 165	050287	—	095704	■	—	18	95 / 125 / -	38 / 8 / -	1 x RSB 16 mini 1 x RSB 16	10
RG M 16 x 140	542407	—	—	■	—	18	95 / - / -	13 / - / -	1 x RSB 16 mini 1 x RSB 16	10
RG M 16 x 190	—	—	050266	—	—	18	95 / 125 / -	63 / 33 / -	1 x RSB 16 mini 1 x RSB 16	10
RG M 16 x 190	050259	—	—	■	—	18	95 / 125 / -	63 / 33 / -	1 x RSB 16 mini 1 x RSB 16	10
RG M 16 x 250	050288	—	050298	■	—	18	95 / 125 / 190	123 / 93 / 28	1 x RSB 16 mini 1 x RSB 16 2 x RSB 16 mini	10
RG M 16 x 270	—	519446	—	—	—	18	95 / 125 / 190	143 / 113 / 48	1 x RSB 16 mini 1 x RSB 16 2 x RSB 16 mini	10
RG M 16 x 300	050289	—	050299	■	—	18	95 / 125 / 190	173 / 143 / 78	1 x RSB 16 mini 1 x RSB 16 2 x RSB 16 mini	10
RG M 16 x 380	095722 2)	—	095712 1)	■	—	18	95 / 125 / 190	253 / 223 / 158	1 x RSB 16 mini 1 x RSB 16 2 x RSB 16 mini	10
RG M 16 x 500	095723 2)	—	095713 1)	■	—	18	95 / 125 / 190	373 / 343 / 278	1 x RSB 16 mini 1 x RSB 16 2 x RSB 16 mini	10
RG M 20 x 220	512251	—	—	■	—	25	- / 170 / -	- / 14 / -	1 x RSB 20	10
RG M 20 x 260	050260	—	050267	■	—	25	- / 170 / 210	- / 54 / 14	1 x RSB 20 1 x RSB 20 E / 24	10
RG M 20 x 290	—	519447	—	—	—	25	- / 170 / 210	- / 84 / 44	1 x RSB 20 1 x RSB 20 E / 24	10
RG M 20 x 350	095707	—	—	■	—	25	- / 170 / 210	- / 144 / 104	1 x RSB 20 1 x RSB 20 E / 24	10
RG M 20 x 350	—	—	095706	—	—	25	- / 170 / 210	- / 144 / 104	1 x RSB 20 1 x RSB 20 E / 24	10
RG M 20 x 500	095725 1)	—	—	■	—	25	- / 170 / 210	- / 294 / 254	1 x RSB 20 1 x RSB 20 E / 24	10
RG M 24 x 295	—	519448 1)	—	—	—	28	- / 210 / -	- / 56 / -	1 x RSB 20 E / 24	10
RG M 24 x 300	050261 1)	—	050268 1)	■	—	28	- / 210 / -	- / 61 / -	1 x RSB 20 E / 24	10
RG M 24 x 400	095727 1)	—	095715 1)	■	—	28	- / 210 / -	- / 161 / -	1 x RSB 20 E / 24	10
RG M 24 x 600	095728 1)	—	—	■	—	28	- / 210 / -	- / 361 / -	1 x RSB 20 E / 24	5
RG M 30 x 380	050262 1)	—	090726 1)	■	—	35	- / 280 / -	- / 65 / -	1 x RSB 30	5
RG M 30 x 500	095730 1)	—	—	■	—	35	- / 280 / -	- / 185 / -	1 x RSB 30	5

1) Straight cut, additional setting tool required

2) Straight cut, setting tool is enclosed.

TECHNICAL DATA IN CONCRETE

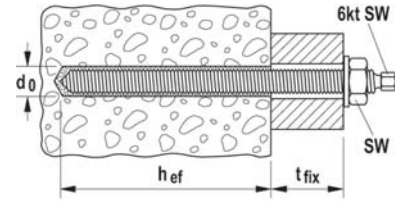

3
Chemical fixings

Item	Highly corrosion resistant steel	Hot-dip galvanised steel	Approval ETA	Drill hole diameter	Effect. anchorage depth	Max. fixture thickness	Hexagon drive	Hexagon nut	Fits capsule RSB	Sales unit [pcs]
	Art.-No.	Art.-No.		d_0 [mm]	h_{ef} [mm]	t_{fix} [mm]	6kt SW [mm]	○ SW [mm]		
	C	hdg								
RG M 10 x 130	096217	—	■	12	90	20	7	17	1 x RSB 10 mini 1 x RSB 10	10
RG M 12 x 160	096218	512247	■	14	110	25	8	19	1 x RSB 12 mini 1 x RSB 12	10
RG M 16 x 165	—	537062	■	18	125	8	12	24	1 x RSB 16 mini 1 x RSB 16	10
RG M 16 x 190	096219	512250	■	18	125	35	12	24	1 x RSB 16 mini 1 x RSB 16	10

TECHNICAL DATA



Filling Sets for subsequent filling of the annular gap

Item	Art.-No.	For use with injection mortar	Match	Sales unit [pcs]
Filling Set M12	537218	FIS SB, FIS EM Plus, FIS V	FIS A M12	10
Filling Set M16	537219	FIS SB, FIS EM Plus, FIS V	FIS A M16	10
Filling Set M20	537220	FIS SB, FIS EM Plus, FIS V	FIS A M 20	10



ADVANTAGES

- The system internal threaded anchor RG M I and an injection mortar for concrete can be individually selected based on requirements, thus allowing for a wide range of applications.
- The internal threaded anchor RG M I allows for surface flush removal and reuse of the fixing point, and therefore offers the best possible flexibility.
- The metric internal thread allows for the use of standard screws or threaded rods for the ideal adaptation to suit the intended use.

VERSIONS

- Zinc-plated steel
- Stainless steel

BUILDING MATERIALS

Approved for:

- Concrete C20/25 to C50/60, non-cracked

Also suitable for:

- Concrete C12/15, non-cracked

FUNCTIONING

- The injection system is suitable for pre-positioned installation when combined with the internal threaded anchor RG M I.
- The mortar is extruded bubble free from the drill hole base.
- The mortar bonds the entire surface of the internal threaded anchor with the drill hole wall and seals the drill hole.
- The internal threaded anchor is set manually, by lightly rotating it until it reaches the drill hole base.

Item	Material		Mortar					Anchor	
	zinc plated, steel grade 5.8	stainless steel	FIS SB	FIS EM Plus	FIS V	FIS VL	FIS GREEN	RSB	RM II
	gvz Art.-No.	A4 Art.-No.	Concrete	Concrete	Concrete	Concrete	Concrete	Concrete	Concrete
RG 8 x 75 M 5 I	48221								
RG 10 x 75 M 6 I	48222								
RG 12 x 90 M 8 I	50552	50565	■	■	■	■	■	■	■
RG 16 x 90 M 10 I	50553	50566	■	■	■	■	■	■	■
RG 18 x 125 M 12 I	50562	50567	■	■	■	■	■	■	■
RG 22 x 160 M 16 I	50563	50568	■	■	■	■	■	■	■
RG 28 x 200 M 20 I	50564	50569	■	■	■	■	■	■	■

■ = approved

TECHNICAL DATA IN CONCRETE



Internal threaded anchor **RG M I**

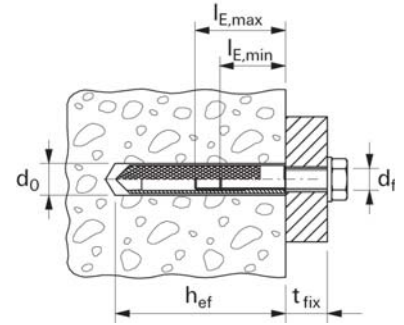

3
Chemical fixings

	Zinc-plated steel	Stainless steel	Approval	Drill hole diameter	Effect. anchorage depth	Min. bolt penetration	Max. bolt penetration	Fits capsules	Sales unit
	Art.-No.	Art.-No.	ETA	d_0 [mm]	h_{ef} [mm]	$l_{E,min}$ [mm]	$l_{E,max}$ [mm]		[pcs]
Item	gvz	A4							
RG 8 x 75 M 5 I	048221 ¹⁾	—	—	10	75	8	14	539796 RM II 8	10
RG 10 x 75 M 6 I	048222 ¹⁾	—	—	12	75	10	16	539797 RM II 10	10
RG 12 x 90 M 8 I	050552 ¹⁾	050565 ¹⁾	—	14	90	8	18	539797 RM II 10	10
RG 16 x 90 M 10 I	050553 ¹⁾	050566 ¹⁾	—	18	90	10	23	539798 RM II 12	10
RG 18 x 125 M 12 I	050562 ¹⁾	050567 ¹⁾	—	20	125	12	26	539800 RM II 16	10
RG 22 x 160 M 16 I	050563 ¹⁾	050568 ¹⁾	—	24	160	16	35	539801 RM II 16 E	5
RG 28 x 200 M 20 I	050564 ¹⁾	050569 ¹⁾	—	32	200	20	45	539803 RM II 24	5

¹⁾ Setting tool is included in each package.



French balconies



Satellite dishes

ADVANTAGES

- The fixing system threaded rod FIS A and an injection mortar can be individually selected based on requirements, thus allowing for a wide range of applications.
- The wide range of approved threaded rods FIS A from M6 to M16 allows for various applications.
- The internal threaded anchor FIS E allows for surface flush removal and reuse of the fixing point, and therefore offers the best possible flexibility.

VERSIONS

- Zinc-plated steel
- Stainless steel

BUILDING MATERIALS

Approved for:





- Solid sand-lime brick
- Solid brick

Also suitable for:

- Solid and lightweight concrete blocks
- Solid pumice and other solid building materials

FUNCTIONING

- FIS E is suitable for pre-positioned installation, whilst FIS A is suitable for pre-positioned and push-through installation.
- The mortar bonds the entire surface of the anchor with the drill hole wall and seals the drill hole.
- The anchor is set manually, by lightly rotating it until it reaches the drill hole base.
- In general, it is also possible to use the FIS H K anchor sleeves in solid brick masonry, and this provides additional safety when the base material is unknown. Technical data see page 168.

Item	zinc plated, steel grade 5.8 gvz Art.-No.	 FIS V  FIS VL  FIS P Plus  FIS GREEN			
		FIS V	FIS VL	FIS P Plus	FIS GREEN
FIS E 11 x 85 M6	43631	■	■	■	■
FIS E 11 x 85 M8	43632	■	■	■	■
FIS E 15 x 85 M10	43633	■	■	■	■
FIS E 15 x 85 M12	43634	■	■	■	■

■ = approved

TECHNICAL DATA IN SOLID BRICK MASONRY



Internal threaded sockets FIS E

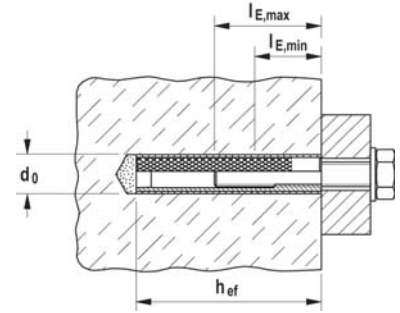

	Zinc-plated steel	Approval	Drill hole diameter	Effect. anchorage depth	Min. bolt penetration	Max. bolt penetration	Fill quantity for effect. anchorage depth in solid brick masonry	Sales unit
	Art.-No.	ETA	d_0 [mm]	h_{ef} [mm]	$l_{E,min}$ [mm]	$l_{E,max}$ [mm]	[scale units]	[pcs]
Item	gvz							
FIS E 11 x 85 M6	043631	■	14	85	6	60	4	10
FIS E 11 x 85 M8	043632	■	14	85	8	60	4	10
FIS E 15 x 85 M10	043633	■	18	85	10	60	5	10
FIS E 15 x 85 M12	043634	■	18	85	12	60	5	10

TECHNICAL DATA IN PERFORATED BRICK MASONRY



Internal threaded sockets FIS E

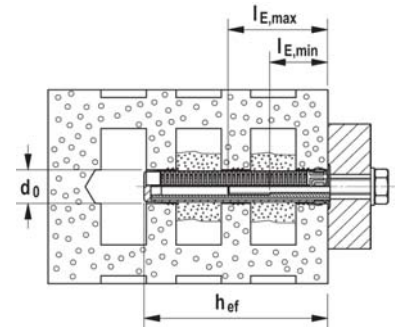

	Zinc-plated steel	Approval	Drill hole diameter in perforated brick masonry	Effect. anchorage depth	Min. bolt penetration	Max. bolt penetration	Suitable injection anchor sleeve	Sales unit
	Art.-No.	ETA	d_0 [mm]	h_{ef} [mm]	$l_{E,min}$ [mm]	$l_{E,max}$ [mm]		[pcs]
Item	gvz							
FIS E 11 x 85 M6	043631	■	16 20	85	6	60	FIS H 16 x 85 K FIS H 20 x 85 K	10
FIS E 11 x 85 M8	043632	■	16 20	85	8	60	FIS H 16 x 85 K FIS H 20 x 85 K	10
FIS E 15 x 85 M10	043633	■	20	85	10	60	FIS H 20 x 85 K	10
FIS E 15 x 85 M12	043634	■	20	85	12	60	FIS H 20 x 85 K	10

TECHNICAL DATA IN UNDERCUT DRILL HOLE IN AERATED CONCRETE



Internal threaded sockets FIS E

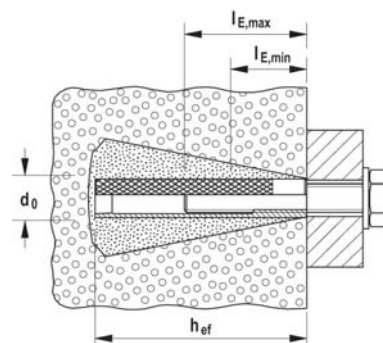

	Zinc-plated steel	Approval	Drill hole diameter in undercut drill hole	Min. anchorage depth in undercut drill hole	Min. bolt penetration	Max. bolt penetration	Fill quantity for effect. anchorage depth in aerated concrete	Sales unit
Item	Art.-No.	ETA	[mm]	[mm]	$l_{E,min}$ [mm]	$l_{E,max}$ [mm]	[scale units]	[pcs]
	gvz							
FIS E 11 x 85 M6	043631	■	14	85	6	60	20	10
FIS E 11 x 85 M8	043632	■	14	85	8	60	20	10

The ETA also allows that the internal threaded sockets FIS E M6 - M12 can be anchored in cylindric drilled holes.

TECHNICAL DATA IN CYLINDRICAL DRILL HOLE IN AERATED CONCRETE



Internal threaded sockets FIS E

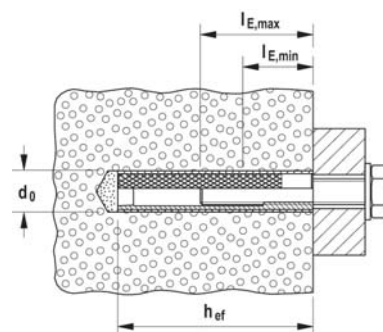

	Zinc-plated steel	Approval	Drill hole diameter in cylindrical drill hole	Min. anchorage depth in cylindrical drill hole	Min. bolt penetration	Max. bolt penetration	Fill quantity for effect. anchorage depth in aerated concrete	Sales unit
Item	Art.-No.	ETA	[mm]	h_{ef} [mm]	$l_{E,min}$ [mm]	$l_{E,max}$ [mm]	[scale units]	[pcs]
	gvz							
FIS E 11 x 85 M6	043631	■	14	85	6	60	20	10
FIS E 11 x 85 M8	043632	■	14	85	8	60	20	10
FIS E 15 x 85 M10	043633	■	18	85	10	60	—	10
FIS E 15 x 85 M12	043634	■	18	85	12	60	—	10

The ETA also allows that the internal threaded sockets FIS E M6 - M12 can be anchored in cylindric drilled holes.

Simple push-through installation in masonry



3
Chemical fixings

VERSIONS

- Zinc-plated steel
- Stainless steel

BUILDING MATERIALS

Approved for:

- Vertically perforated brick
- Hollow blocks made from lightweight concrete
- Hollow blocks made from concrete
- Perforated sand-lime brick
- Solid sand-lime brick
- Solid brick

Also suitable for:

- Hollow pumice slabs
- Slabs made of hollow brick and other perforated brick
- Solid pumice and other solid building materials

CERTIFICATES



ADVANTAGES

- The direct installation through the fixture reduces preliminary work whenever there are several fixing points for each fixture, and guarantees a significantly simpler installation process.
- The design of the push-through anchor sleeve FIS H K allows for a range of usable lengths with just one product, thus providing maximum flexibility and cost-effectiveness.
- The movable edge, in combination with the scale, makes it easier to adapt the anchor sleeve to suit the desired usable length.
- The grating structure of the push-through anchor sleeve is adapted for the injection mortars FIS V, FIS VV HIGH SPEED, FIS VS LOW SPEED, FIS GREEN and FIS P Plus, and ensures sparing mortar use with the best interlock.

APPLICATIONS

- Timber constructions
- Awnings
- Canopies
- Car ports
- Gates

FUNCTIONING

- The system can be used with any of the following injection mortars: FIS V or FIS GREEN. FIS P can be used but does not have approvals.
- The injection system is suitable for push-through installation when combined with the push-through anchor sleeve FIS H K.
- The push-through anchor sleeve is adapted to suit the fixture thickness using the scale and the movable edge, and cut as required.
- The anchor sleeve is placed in the drill hole, and filled with injection mortar from the anchor sleeve base. It should be ensured that the anchor sleeve is completely filled, including in the fixture region.
- Turning in the anchor causes the mortar to be pushed through the anchor sleeve's grating structure, so that it fits the base material perfectly. The load is borne by the interlock.

INSTALLATION WITH FIS V AND FIS HK

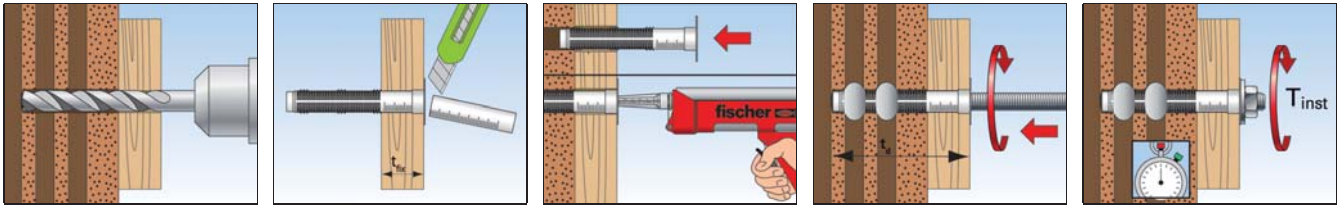

TECHNICAL DATA



Injection push-through anchor sleeve **FIS HK**

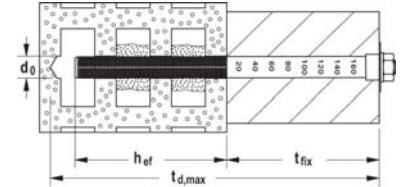

Item	Art.-No.	Approval ETA	Drill hole diameter	Max. drill hole depth	Effect. anchorage depth	Max. fixture thickness	Match	Fill quantity [scale units]	Sales unit [pcs]
			d_0 [mm]	[mm]	h_{ef} [mm]	t_{fix} [mm]			
FIS H 18 x 130/200 K	045707	■	18	340	130	200	M10 - M12	35	10
FIS H 22 x 130/200 K	045708	■	22	340	130	200	M 16	45	10

TECHNICAL DATA



FIS Set 18 x 130/200 M12/200

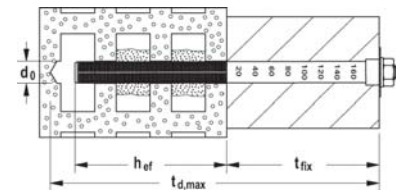

Item	Zinc-plated steel	Stainless steel	Approval ETA	Drill hole diameter	Max. drill hole depth	Effect. anchorage depth	Max. fixture thickness	Fill quantity [scale units]	Sales unit [pcs]
	Art.-No.	Art.-No.		d_0 [mm]	[mm]	h_{ef} [mm]	t_{fix} [mm]		
	gvz	A4							
FIS Set 18 x 130/200 M12/200	047443	047452	■	18	340	130	200	35	5

LOADS

Injection system FIS V with threaded rod FIS A⁵⁾ and push-through anchor sleeve FIS H..K

Highest permissible loads¹⁾⁶⁾ for a single anchor in perforated brick masonry (with push-through anchor sleeve) for push-through installation.

For the design the complete assessment ETA-10/0383 has to be considered.

Type of anchor sleeve with threaded rod	Compressive-brick-strength f_b [N/mm ²]	Brick raw density ρ [kg/dm ³]	Minimum brick-dimensions ⁷⁾ (L x W x H) [mm]	Min. effective-anchorage depth ⁴⁾ h_{ef} [mm]	Min. member thickness h_{min} [mm]	Maximum torque $T_{inst,max}$ [Nm]	Permissible tensile load ³⁾ N_{perm} [kN]	Permissible shear load ³⁾ V_{perm} [kN]	Characteristic spacing parallel to bed joint $s_{cr \parallel}$ [mm]	Characteristic spacing perpendicular to bed joint $s_{cr \perp}$ [mm]	Min. spacing ²⁾ $s_{min \parallel} / s_{min \perp}$ [mm]	Characteristic resp. min. edge distance ²⁾ $c_{cr} = c_{min}$ [mm]
Vertically perforated brick Hlz, shape B acc. to EN 771-1												
18x130/200 M10/M12	≥ 4	≥ 0,7	500x200x300	130	200	2	0,34	0,17	500	300	100 / 300	80
22x130/200 M16	≥ 4						0,43	0,17				
18x130/200 M10/M12	≥ 6						0,57	0,26				
22x130/200 M16	≥ 6						0,71	0,26				
18x130/200 M10/M12	≥ 8						0,71	0,34				
22x130/200 M16	≥ 8						0,86	0,34				
18x130/200 M10/M12	≥ 10						0,86	0,43				
22x130/200 M16	≥ 10						1,14	0,43				
Perforated sand-lime brick KSL acc. to EN 771-2												
18x130/200 M10/M12	≥ 8	≥ 1,4	240x175x113	130	175	2	0,71	0,86	240	115	100 / 115	80
22x130/200 M16	≥ 8						0,71	0,71				
18x130/200 M10/M12	≥ 12						1,00	1,29				
22x130/200 M16	≥ 12						1,00	1,14				
18x130/200 M10/M12	≥ 16						1,29	1,71				
22x130/200 M16	≥ 16						1,29	1,57				
18x130/200 M10/M12	≥ 20						1,71	1,71				
22x130/200 M16	≥ 20						1,71	1,71				
Lightweight concrete hollow block Hbl acc. to EN 771-3												
18x130/200 M10/M12	≥ 2	≥ 1,0	362x240x240	130	240	2	0,43	0,26	365	240	100 / 240	60
and 22x130/200 M16	≥ 4						0,86	0,57				

¹⁾ The required partial safety factors for material resistance as well as a partial safety factor for load actions of $\gamma_L = 1,4$ are considered.

²⁾ Minimum feasible spacings resp. edge distance. Details as well as to the distances to joints see assessment.

³⁾ For combinations of tensile loads, shear loads, bending moments as well as reduced edge distances or spacings (anchor groups) see assessment.

⁴⁾ The maximum anchorage depth is corresponding with the relevant push-through anchor sleeves FIS H18.. K and FIS H22.. K (see technical data).

⁵⁾ Zinc-plated, stainless steel A4 and high corrosion-resistant steel C.

⁶⁾ The given loads are valid for installation and use of fixations in dry masonry - use category d/d - for temperatures in the substrate up to +50 °C (resp. short term up to 80 °C) and drill hole cleaning according to assessment. The given brick types in combination with the permissible loads are an extract of the assessment.

⁷⁾ Hole patterns see assessment.

FIS H K



FIS H L



FIS H N



ADVANTAGES

- The grating structure of the FIS H K anchor sleeve is adapted for the injection mortars FIS V, FIS GREEN and FIS P Plus, and ensures sparing mortar use with the best interlock.
- The centring blades perfectly align the anchor in the anchor sleeve, and allow for use with various threaded rod diameters.
- The barbed hooks secure the anchor sleeve in the drill hole and allow for a trouble-free overhead installation.
- The geometry of the anchor sleeves allows for the bridging of non-bearing layers for a simple and convenient installation.

FUNCTIONING

- The system can be used with any of the following injection mortars: FIS V, FIS VW HIGH SPEED, FIS VS LOW SPEED, FIS GREEN or FIS P Plus. FIS P can be used but does not have approvals.
- The system is suitable for pre-positioned installation when combined with injection anchor sleeves and threaded rods FIS A or internal threaded anchors FIS E.
- The anchor sleeve is placed in the drill hole, and filled with injection mortar from the anchor sleeve base.
- Turning in the anchor causes the mortar to be pushed through the anchor sleeve's grating structure, so that it fits the base material perfectly. The load is borne by the interlock.

ADVANTAGES

- The metal anchor sleeve can be cut to the required length and thus allows for a range of usable lengths with just one produce, providing flexibility and cost-effectiveness.
- The grating structure of the anchor sleeve allows for uniform distribution of mortar in the drill hole and thus for secure hold.

FUNCTIONING

- The anchor sleeve is at first cut to the required length.
- The anchor sleeve is placed in the drill hole, and filled with injection mortar from the anchor sleeve base.
- Turning in the anchor causes the mortar to be pushed through the anchor sleeve's grating structure, so that it fits the base material perfectly.
- The load is borne by the interlock.

ADVANTAGE

- The net structure of the anchor sleeve allows for uniform distribution of mortar in the drill hole and thus for secure hold.

FUNCTIONING

- The anchor sleeve is placed in the drill hole, and filled with injection mortar from the anchor sleeve base.
- Turning in the anchor causes the mortar to be pushed through the anchor sleeve's grating structure, so that it fits the base material perfectly.
- The load is borne by the interlock.

TECHNICAL DATA



Injection anchor sleeve **FIS H K**

Item	Art.-No.	Approval ETA	Drill hole diameter d_0 [mm]	Drill hole depth acc. ETA [mm]	Effect. anchorage depth h_{ef} [mm]	Match	Fill quantity per sleeve [scale units]	Sales unit [pcs]
FIS H 12 x 50 K	041900	■	12	55	50	FIS A M6-M8	5	50
FIS H 12 x 85 K	041901	■	12	90	85	FIS A M6-M8	10	50
FIS H 16 x 85 K	041902	■	16	90	85	FIS A M8-M10, FIS E M6-M8	12	50
FIS H 16 x 130 K	041903	■	16	135	110	FIS A M8-M10	15	20
FIS H 20 x 85 K	041904	■	20	90	85	FIS A M12-M16, FIS E M10-M12	15	20
FIS H 20 x 130 K	046703	■	20	135	110	FIS A M12-M16	25	20
FIS H 20 x 200 K	046704	■	20	205	180	FIS A M12-M16	40	20

TECHNICAL DATA



Injection anchor sleeve, 1 m length **FIS H L**

Item	Art.-No.	Drill hole diameter d_0 [mm]	Total length l [mm]	Match	Fill quantity per 10 cm	Sales unit [pcs]
FIS H 12 x 1000 L	050598	12	1000	Ø6 / M 6 - Ø8 / M 8	12	10
FIS H 16 x 1000 L	050599	16	1000	Ø10/M10 / Ø12/M12	14	10
FIS H 22 x 1000 L	045301	22	1000	Ø12/M12 - Ø16/M16	20	6
FIS H 30 x 1000 L	000645	30	1000	Ø16/M16 - Ø22/M22	26	4

TECHNICAL DATA





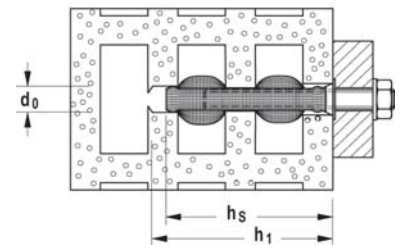









Injection anchor sleeve with net **FIS H N**



Item	Art.-No.	Drill hole diameter d_0 [mm]	Min. drill hole depth h_1 [mm]	Min. anchorage depth anchor h_v [mm]	Fill quantity per sleeve [scale units]	Match	Sales unit [pcs]
FIS H 16 x 85 N	050470	16	95	90	15	Ø8/M8	20
FIS H 18 x 85 N	050472	18	95	90	17	Ø10/M10	20
FIS H 20 x 85 N	050474	20	95	90	18	Ø12/M12	20

Special Applications

Item									Page
 Highbond anchor dynamic FHB dyn	Performance class amongst dynamic anchors	■							170
 Dynamic-anchor FDA	Dynamic push-through anchor for an economical serial installation at medium load level	■							174
 UMV multicone dynamic bonded anchor	The capsule system for the anchoring of dynamic loads							■	176
 Rebar Connections	Professional rebar connections	■	■	■	■	■	■		179
 Concrete- Concrete Shear Connector FCC	Approved system for building renovation	■	■	■		■			185
 Remedial Wall Tie VBS 8	Facade repair for two-leaf cavity walls					■			187
 Weather Facing Reconstruction System FWS II	Economical repair of triple-skin outer wall panels					■			189

■ = approved
 (■) = recommendation

The performance class amongst dynamic anchors

3
Chemical fixings



Production robots

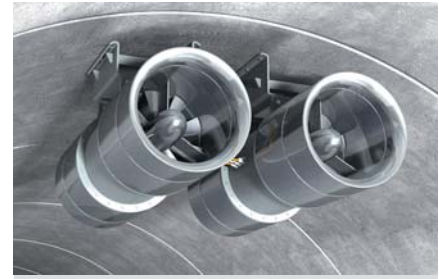

Tunnel ventilators

VERSIONS

- Zinc-plated steel
- Highly corrosion-resistant steel

BUILDING MATERIALS

Approved for:

- Concrete C20/25 to C50/60, cracked and non-cracked

CERTIFICATES

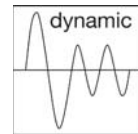

ADVANTAGES

- During the setting process, the injection mortar FIS HB fills the annular gap in the fixture, and ensures optimum load distribution. This allows for the absorption of dynamic alternating loads.
- The cone shape of the FHB-A dyn anchor rod ensures a controlled expansion under dynamic stress, thus allowing for use in cracked concrete.
- The anchor rod FHB-A dyn is also available made from highly corrosion-resistant steel. This makes it suitable for use in aggressive atmospheres, for example in tunnels.
- The Highbond anchor dynamic system can achieve even greater shear loads thanks to the additional sleeve of the anchor rod FHB-A dyn V, and therefore provides an increased level of safety.

APPLICATIONS

- Jib cranes
- Gantry and overhead cranes
- Guide rails for elevators
- Tunnel ventilators (jet fans)
- Gantries in road construction
- Antennas and transmitter masts
- Industrial robots

FUNCTIONING

- The injection system suitable for tensile zones consists of the Highbond dynamic anchor rod FHB-A dyn and the injection mortar FIS HB.
- FHB dyn is approved for pre-positioned and push-through installation.
- Extruding the mortar causes the two components to be mixed and activated in the static mixer.
- The mortar bonds the entire surface of the anchor rod with the drill hole wall and seals the drill hole.
- The centring sleeve centres the anchor in the fixture, thus ensuring a safe load application.
- The lock nut prevents the nut from becoming loose.

PRE-POSITIONED INSTALLATION IN CONCRETE WITH FIS HB AND FHB DYN

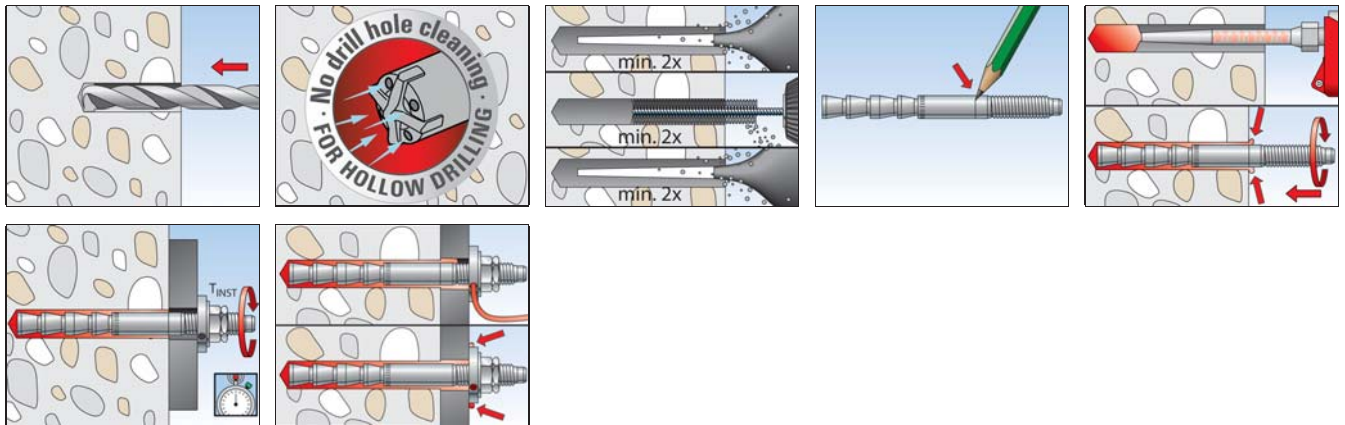

PUSH-THROUGH INSTALLATION IN CONCRETE WITH FIS HB AND FHB DYN

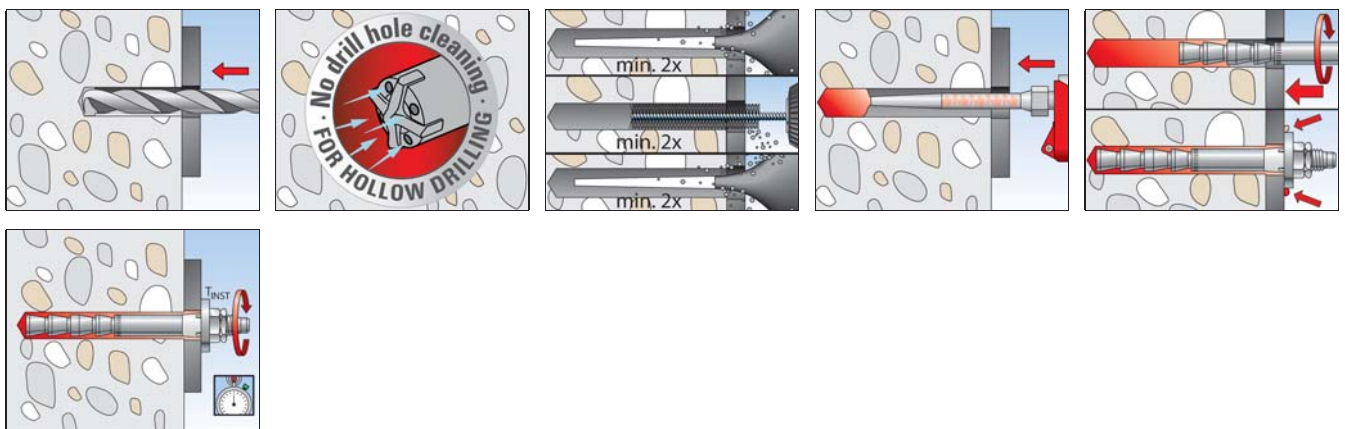

PUSH-THROUGH INSTALLATION IN CONCRETE WITH FIS HB AND FHB DYN V

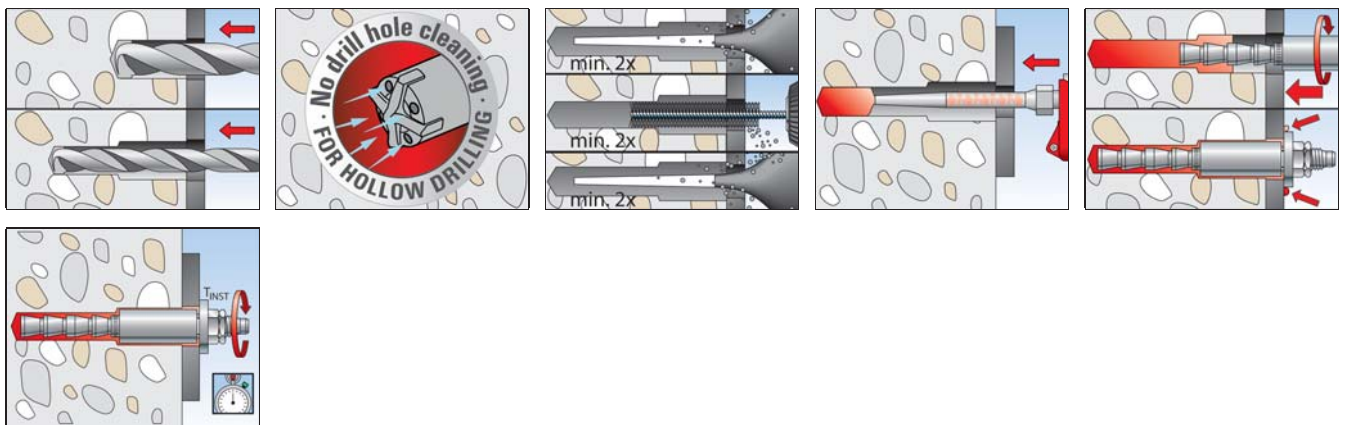

TECHNICAL DATA



Highbond anchor dynamic **FHB-A dyn**

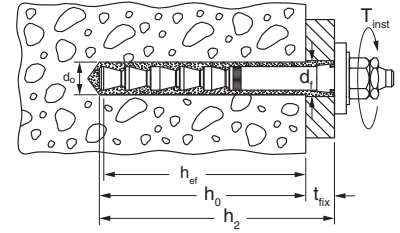

Chemical fixings 3

Item	Zinc-plated steel	Highly corrosion resistant steel	Approval DIBt	Drill hole diameter	Min. drill hole depth for through fixings	Anchorage depth	Min. - max. usable length	Drill hole diameter in fixture	Width across nut	Sales unit
	Art.-No.	Art.-No.		d_0 [mm]	h_2 [mm]	h_{ef} [mm]	t_{fix} [mm]	d_f [Ø mm]	○ SW [mm]	[pcs]
	gvz	C								
FHB-A dyn 12 x 100/25	092018	531384 1)	●	14	130	100	8 - 25	15	19	10
FHB-A dyn 12 x 100/50	092019	—	●	14	155	100	8 - 50	15	19	10
FHB-A dyn 16 x 125/25	092020	—	●	18	155	125	10 - 25	19	24	10
FHB-A dyn 16 x 125/50	092036	093445 1)	●	18	180	125	10 - 50	19	24	10
FHB-A dyn 20 x 170/50	092037	—	●	24	225	170	12 - 50	25	30	10
FHB-A dyn 24 x 220/50	092038	—	●	28	275	220	14 - 50	29	36	5

1) Prices and delivery time on request.

TECHNICAL DATA



Highbond anchor dynamic **FHB-A dyn V**

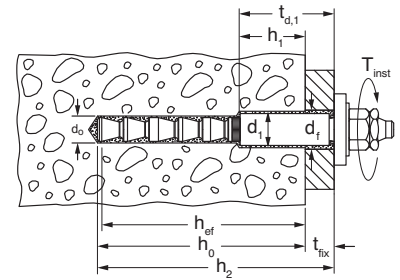

Item	Zinc-plated steel	Approval DIBt	Drill hole diameter	Min. drill hole depth for through fixings	Anchorage depth	Min. - max. usable length	Drill hole diameter in fixture	Width across nut	Sales unit
	Art.-No.		d_0 [mm]	h_2 [mm]	h_{ef} [mm]	t_{fix} [mm]	d_f [Ø mm]	○ SW [mm]	[pcs]
	gvz								
FHB-A dyn 12 x 100/50 V	092039 1)	●	14	160	105	8 - 50	21	19	10
FHB-A dyn 16 x 125/50 V	092040 2)	●	18	185	130	10 - 50	29	24	10

1) Stepped hole: 1st drill hole with Ø 20 mm and depth 85 mm. 2nd drill hole with Ø 14 mm and depth 160 mm.

2) Stepped hole: 1st drill hole with Ø 28 mm and depth 100 mm. 2nd drill hole with Ø 18 mm and depth 185 mm.

TECHNICAL DATA



Injection mortar **FIS HB 345 S**



Injection mortar **FIS HB 150 C**



Static mixer **FIS MR Plus**

Item	Art.-No.	Approval DIBt	Languages on the cartridge	Contents	Sales unit
					[pcs]
FIS HB 345 S	033211	●	DE, GB, FR, ES, NL, CS	1 cartridge 360 ml, 2 x FIS MR Plus	6
FIS HB 150 C	519665	●	DE, FR, NL	1 cartridge 145 ml, 2 x FIS MR Plus	6
FIS MR Plus	545853	—	—	10 static mixer FIS MR Plus	10

CURING TIME - FIS HB

Cartridge temperature FIS HB (minimum + 5°C)	Gelling time FIS HB	Temperature at anchoring base	Curing time FIS HB
		- 5°C - ± 0°C	360 min.
		± 0°C - + 5°C	180 min.
+ 5°C - +20°C	15 min.	+ 5°C - +20°C	90 min.
+20°C - +30°C	6 min.	+20°C - +30°C	35 min.
+30°C - +40°C	4 min.	+30°C - +40°C	20 min.
> +40°C	2 min.	> +40°C	12 min.

Please note: The curing times apply for dry anchoring bases, in damp anchoring bases they should be doubled. Remove water from drill hole.

FILLING QUANTITIES

Type	Mortar volume in scale units shown on the cartridge labels' corresponding scale	Anchors per cartridge FIS HB 345 S ^{*)}
FHB-A dyn 12 x 100 / 25	7	24
FHB-A dyn 12 x 100 / 50	8	21
FHB-A dyn 16 x 125 / 25	9	18
FHB-A dyn 16 x 125 / 50	10	17
FHB-A dyn 20 x 170 / 50	23	7
FHB-A dyn 24 x 220 / 50	38	4
FHB-A dyn 12 x 100 / 50 V	12	14
FHB-A dyn 16 x 125 / 50 V	20	8

*) max. number with one static mixer

LOADS

Highbond anchor dynamic FHB dyn

zinc-plated steel / high corrosion-resistant steel C

Design values for cyclic fatigue loading ¹⁾ of a single anchor in cracked or non-cracked normal concrete of strength class C20/25 ³⁾										Minimum spacings while reducing the load	
Type	Material fixing element	Effective anchorage depth h_{ef} [mm]	Minimum member thickness $h_{min}^{5)}$ [mm]	Installation torque T_{inst} [Nm]	Design value of tensile load $\Delta N_{Ed,max}^{2)}$ [kN]	Design value of shear load $\Delta V_{Ed,max}^{2,9)}$ [kN]	Required edge distance (with one edge) for		Required spacing for Max. Load $s_{cr}^{6)}$ [mm]	Min. spacing $s_{min}^{5)}$ [mm]	Min. edge distance $c_{min}^{5)}$ [mm]
							Max. tension load $\Delta N_{Ed}^{c^{8)}$ [mm]	Max. shear load $\Delta V_{Ed}^{c^{8)}$ [mm]			
FHB dyn 12 x 100	gvz C / 1.4529	100	130	40	14,1	6,7	200	200	300	100	200 ⁴⁾⁷⁾
			200				100	100 ⁴⁾			
			130		11,3	4,4	200	200			200 ⁴⁾⁷⁾
			200				100	100 ⁴⁾⁷⁾			
FHB dyn 12 x 100 V	gvz	105	130	40	14,1	9,6	200	200	315	100	200 ⁴⁾⁷⁾
			200				105	130			100
FHB dyn 16 x 125	gvz C / 1.4529	125	160	60	23,0	11,9	200	200	375	100	200 ⁴⁾⁷⁾
			250				185	145			100
			160		15,6	11,9	200	200			200 ⁴⁾⁷⁾
			250				100	145			100 ⁷⁾
FHB dyn 16 x 125 V	gvz	130	160	60	23,0	17,0	200	260	375	100	200 ⁷⁾
			250				170	200			100
FHB dyn 20 x 170	gvz	170	220	100	28,4	17,0	175	190	510	80	80
FHB dyn 24 x 220	gvz	220	440	120	28,9	22,2	180	200	660	180	180 ⁷⁾

For the design the complete approval Z-21.3-1748 has to be considered.

¹⁾ The design values of the cyclic fatigue loading apply for $\geq 5 \times 10^6$ load cycles in accordance with design method I - for unknown static lower load. If the static lower load is known and / or for lower number of load cycles higher load values are possible. The partial safety factors as regulated in the approval are considered. As a single anchor counts e.g. an anchor with a spacing $s \geq 3 \times h_{ef}$. The given load values apply for anchorages in dry and wet concrete and temperatures in the base material up to +50 °C (resp. short-term up to +80 °C) and drill hole cleaning in accordance with the approval.

²⁾ For combinations of tensile loads, shear loads, bending moments as well as reduced edge distances or spacings (anchor groups) a detailed anchor design is required.

³⁾ For higher concrete strength classes up to C50/60 higher permissible loads may be possible. - see approval. The concrete is assumed to be standard-reinforced.

⁴⁾ Without reduction of the shear load.

⁵⁾ Intermediate values for h_{min} may be applied in accordance with table 5 resp. 7 of the approval Z-21.3-1748 considering the influence on s_{min} and c_{min} .

⁶⁾ A splitting reinforcement, which limits the crack width to $\sim 0,3$ mm considering the splitting forces, is assumed to be available. For an actual edge distance, which is smaller than the characteristic edge distance $c_{cr,N}$ a longitudinal reinforcement of at least diameter 6 mm in the area of the anchorage depth of the anchor must be available.

⁷⁾ Without reduction of the shear load.

⁸⁾ Values apply for predominantly non-static (dynamic) actions. For predominantly static actions differing values can be decisive.

⁹⁾ Valid for pulsating loads. For alternating loads see approval.

The dynamic push-through anchor for an economical serial installation at medium load level



Platform lifts

3
Chemical fixings

VERSIONS

- Zinc-plated steel

BUILDING MATERIALS

- Concrete C20/25 to C50/60, cracked and non-cracked

CERTIFICATES

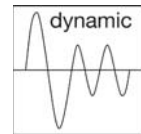

ADVANTAGES

- Medium load level for a variety of applications.
- Pre-assembled anchor rod for fast installation.
- Approved safety by DIBt-Approval for endless numbers of load cycles.
- Easy push-through installation leads to cost effectiveness – especially for serial installations.
- Tight assortment with the size.
- Less spacings and edge distances.
- Drill holes are sealed.

APPLICATIONS

- hydraulic ramps
- Conveyor belts
- Industrial robots
- cooperation robots and -parts
- Guide rails for elevators

FUNCTIONING

- The injection system suitable for tensile zones consists of the fischer dynamic anchor rod FDA-A dyn and the injection mortar FIS HB.
- FDA is approved push-through installation.
- Extruding the mortar causes the two components to be mixed and activated in the static mixer.
- The mortar bonds the entire surface of the anchor rod with the drill hole wall and seals the drill hole.
- The centring sleeve centres the anchor in the fixture, thus ensuring a safe load application.
- During the setting process, the injection mortar FIS HB fills the annular gap in the fixture, and ensures optimum load distribution. This allows for the absorption of dynamic alternating loads.

INSTALLATION IN CONCRETE WITH FIS HB AND FDA

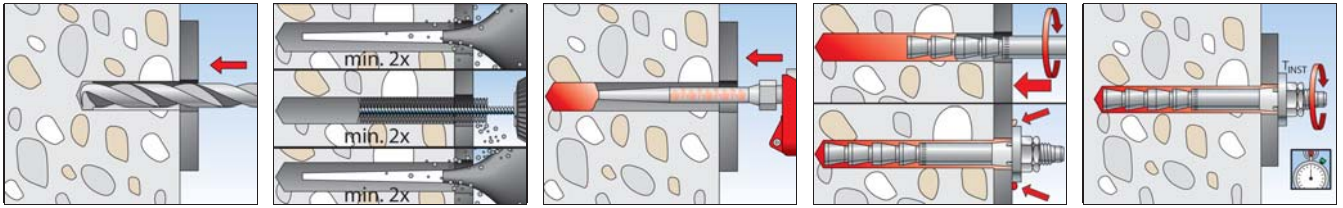

TECHNICAL DATA



Dynamic-Anchor FDA

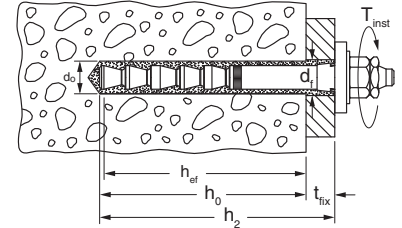

Item	Zinc-plated steel	Approval	Drill hole diameter d_0 [mm]	Drill hole diameter in fixture d_f [Ø mm]	Anchorage depth h_{ef} [mm]	Min. - max. usable length t_{fix} [mm]	Min. drill hole depth for through fixings h_2 [mm]	Width across nut ○ SW [mm]	Sales unit [pcs]
	Art.-No.								
	gvz								
FDA-A 12 x 100/25 gvz	536943	●	14	15	100	12 - 25	130	19	10
FDA-A 12 x 100/50 gvz	536944	●	14	15	100	12 - 50	155	19	10
FDA-A 16 x 125/25 gvz	536945	●	18	19	125	16 - 25	155	24	10
FDA-A 16 x 125/50 gvz	536946	●	18	19	125	16 - 50	180	24	10

LOADS

Dynamic-Anchor FDA
zinc-plated steel

Design values for cyclic fatigue loading ¹⁾ of a single anchor in cracked or non-cracked normal concrete of strength class C20/25 ³⁾										Minimum spacings while reducing the load	
Type	Material fixing element	Effective anchorage depth h_{ef} [mm]	Minimum member thickness h_{min} ⁵⁾ [mm]	Installation torque T_{inst} [Nm]	Design value of tensile load $\Delta N_{Ed,max}$ ²⁾ [kN]	Design value of shear load $\Delta V_{Ed,max}$ ²⁾⁸⁾ [kN]	Required edge distance (with one edge) for		Required spacing for Max. Load s_{cr} ⁶⁾ [mm]	Min. spacing s_{min} ⁵⁾ [mm]	Min. edge distance c_{min} ⁵⁾ [mm]
							Max. tension load ΔN_{Ed} c ⁶⁾⁷⁾ [mm]	Max. shear load ΔV_{Ed} c ⁷⁾ [mm]			
FDA 12 x 100	gvz	100	130	40	11,3	5,1	200	200	300	100	200 ⁴⁾
			200				100	100 ⁴⁾			
FDA 16 x 125	gvz	125	160	60	18,8	9,1	200	200	375	100	200 ⁴⁾
			250				140	115			100

For the design the complete approval Z-21.3-2058 has to be considered.

¹⁾ The design values of the cyclic fatigue loading apply for $\geq 5 \times 10^6$ load cycles in accordance with design method I - for unknown static lower load. If the static lower load is known and / or for lower number of load cycles higher load values are possible. The partial safety factors as regulated in the approval are considered. As a single anchor counts e.g. an anchor with a spacing $s \geq 3 \times h_{ef}$. The given load values apply for anchorages in dry and wet concrete and temperatures in the base material up to +50 °C (resp. short-term up to +80 °C) and drill hole cleaning in accordance with the approval.

²⁾ For combinations of tensile loads, shear loads, bending moments as well as reduced edge distances or spacings (anchor groups) a detailed anchor design is required.

³⁾ For higher concrete strength classes up to C50/60 higher permissible loads may be possible. - see approval. The concrete is assumed to be standard-reinforced.

⁴⁾ Without reduction of the shear load.

⁵⁾ Intermediate values for h_{min} may be applied in accordance with table 5 of the approval Z-21.3-2058 considering the influence on s_{min} and c_{min} .

⁶⁾ A splitting reinforcement, which limits the crack width to $\sim 0,3$ mm considering the splitting forces, is assumed to be available. For an actual edge distance, which is smaller than the characteristic edge distance $c_{cr,N}$, a longitudinal reinforcement of at least diameter 6 mm in the area of the anchorage depth of the anchor must be available.

⁷⁾ Values apply for predominantly non-static (dynamic) actions. For predominantly static actions differing values can be decisive.

⁸⁾ Valid for pulsating loads. For alternating loads see approval.

The capsule system for the anchoring of dynamic loads

Chemical fixings 3



Slewing cranes



Guide rails for elevators

VERSIONS

- Zinc-plated steel

BUILDING MATERIALS

Approved for:

- Concrete C20/25 to C50/60, cracked and non-cracked

CERTIFICATES

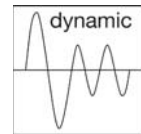

ADVANTAGES

- The bushing fills the annular gap in the fixture and, in combination with the anchor rod UMV-A dyn, ensures an even load distribution. This allows for the bearing of dynamic alternating loads.
- The cone shape of the UMV-A dyn anchor rod ensures a controlled expansion under dynamic stress, thus allowing for use in cracked concrete.
- The pre-portioned resin capsule ensures a quick and easy installation on the construction site, and helps to avoid errors.
- The glass particles of the capsule body rough up the drill hole wall during the setting process, and improve the bond between the anchor rod and concrete.

APPLICATIONS

- Jib cranes
- Gantry and overhead cranes
- Guide rails for elevators
- Antennas and transmitter masts
- Industrial robots

FUNCTIONING

- The bonded anchor suitable for tensile zones consists of the UMV multicone dynamic anchor rod and the UMV multicone resin capsule.
- UMV multicone dynamic is suitable for pre-positioned and push-through installation.
- During setting (rotating/hitting), the tip of the anchor rod destroys the capsule in the drill hole, and mixes and activates the mortar.
- The mortar bonds the entire surface of the anchor rod with the drill hole wall and seals the drill hole.
- Once the fixture has been positioned, the installation sleeve is used to drive the bushing over the anchor rod.

PRE-POSITIONED INSTALLATION IN CONCRETE WITH CAPSULE UMV-P AND UMV-A DYN

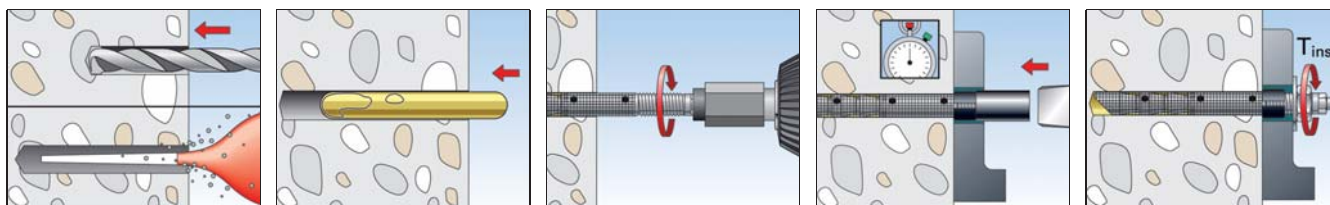

PUSH-THROUGH INSTALLATION IN CONCRETE WITH CAPSULE UMV-P AND UMV-A DYN

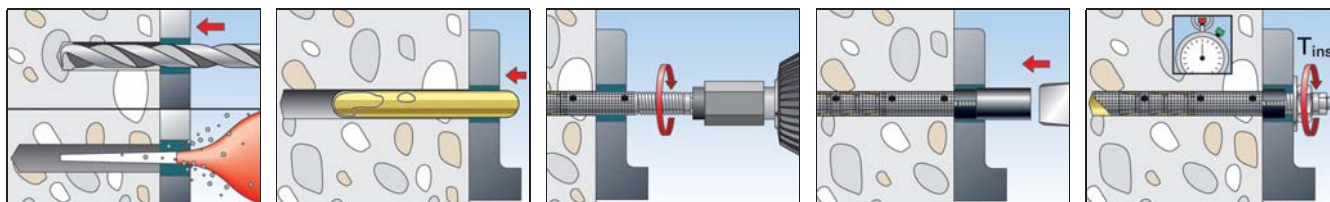

TECHNICAL DATA

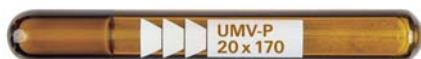

UMV multicone chemical anchor capsule

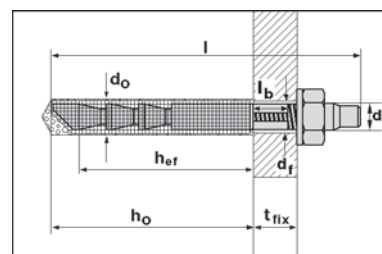

Item	Art.-No.	Approval DIBt	Drill diameter	Drill hole depth	Sales unit
			[mm]	[mm]	[pcs]
UMV-P 12 x 100	007947	●	15	115	10
UMV-P 16 x 125	007948	●	18	140	10
UMV-P 20 x 170	007949	●	25	190	10
UMV-P 24 x 220	007973	●	28	245	5

TECHNICAL DATA



UMV multicone dynamic anchor rod

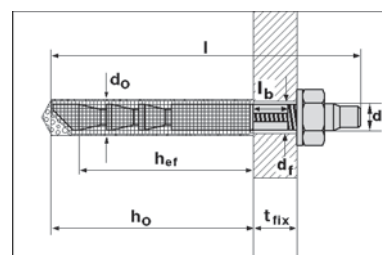

Item	Zinc-plated steel	Approval DIBt	Drill hole diameter	Total length	Min. fixing thickness	Max. fixing thickness	Through hole	Clamping bush height	Qty. per pack threaded rod	Qty. per pack clamping chuck
	Art.-No.		d_0 [mm]	l [mm]	t_{fix} [mm]	t_{fix} [mm]	d_f [mm]	l_b [mm]	[pcs]	[pcs]
UMV-A dyn 12 x 100/10	007943	●	15	145	5	10	16	5	10	10
UMV-A dyn 12 x 100/15	007988	●	15	150	8	15	16	8	10	10
UMV-A dyn 12 x 100/25	008004	●	15	160	15	25	16	15	10	10
UMV-A dyn 12 x 100/50	008005	●	15	185	25	50	16	15	10	10
UMV-A dyn 16 x 125/30	008006	●	18	200	15	30	19	15	10	10
UMV-A dyn 16 x 125/60	008007	●	18	230	30	60	19	15	10	10
UMV-A dyn 20 x 170/40	008008 1)	●	25	255	20	40	26	20	10	10
UMV-A dyn 24 x 220/50	008009 1)	●	28	325	25	50	29	25	5	5

1) Without external hexagon. Please use a separate setting tool.

LOADS

UMV multicone dynamic bonded anchor

zinc-plated steel

Design values for cyclic fatigue loading ¹⁾ of a single anchor in cracked or non-cracked normal concrete of strength class C20/25 ³⁾										Minimum spacings while reducing the load	
Type	Material fixing element	Effective anchorage depth h_{ef} [mm]	Minimum member thickness h_{min} [mm]	Installation torque T_{inst} [Nm]	Design value of tensile load $\Delta N_{Ed,max}^{2)}$ [kN]	Design value of shear load $\Delta V_{Ed,max}^{2) 6)}$ [kN]	Required edge distance (with one edge) for		Required spacing for Max. Load s_{cr} [mm]	Min. spacing s_{min} [mm]	Min. edge distance c_{min} [mm]
							Max. tension load ΔN_{Ed} $c^{5)}$ [mm]	Max. shear load ΔV_{Ed} $c^{5)}$ [mm]			
UMV dyn 100 M12	gvz	100	200	40	12,2	5,6	125	100	300	100	100 ⁴⁾
UMV dyn 125 M16	gvz	125	250	60	14,8	6,7	130	130	375	130	130 ⁷⁾
UMV dyn 170 M20	gvz	170	340	100	31,4	16,3	255	170	510	170	170 ⁴⁾
UMV dyn 220 M24	gvz	220	440	120	38,5	16,3	260	220	660	220	220 ⁴⁾

For the design the complete approval Z-21.3-1662 has to be considered.

¹⁾ The design values of the cyclic fatigue loading apply for $\geq 5 \times 10^6$ load cycles in accordance with design method I - for unknown static lower load. If the static lower load is known and / or for lower number of load cycles higher load values are possible. The partial safety factors as regulated in the approval are considered. As a single anchor counts e.g. an anchor with a spacing $s \geq 3 \times h_{ef}$. The given load values apply for anchorages in dry and wet concrete and temperatures in the base material up to +50 °C (resp. short-term up to +80 °C) and drill hole cleaning in accordance with the approval.

²⁾ For combinations of tensile loads, shear loads, bending moments as well as reduced edge distances or spacings (anchor groups) a detailed anchor design is required.

³⁾ For higher concrete strength classes up to C50/60 higher permissible loads may be possible. - see approval. The concrete is assumed to be standard-reinforced.

⁴⁾ Without reduction of the shear load.

⁵⁾ Values apply for predominantly non-static (dynamic) actions. For predominantly static actions differing values can be decisive.

⁶⁾ Valid for pulsating loads. For alternating loads see approval.

⁷⁾ Without reduction of the tensile and the shear load.

Professional rebar connections



Rebar connections

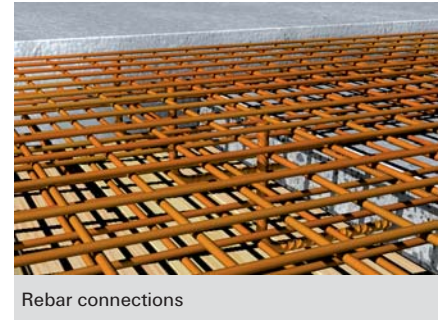

Rebar connections

BUILDING MATERIALS

Approved for:

- Concrete C12/15 to C50/60, cracked and non-cracked

CERTIFICATES

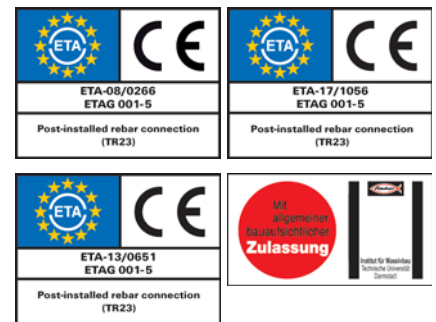

ADVANTAGES

- The injection mortars FIS V and FIS VS LOW SPEED allow for rebar connections from Ø8 to 28 mm, whilst injection mortar FIS EM Plus allows for rebar connections up to Ø40 mm to be carried out. This offers maximum flexibility.
- The injection mortar FIS SB allows the user for realizing rebar connections from Ø 8 to 32 mm in combination with a simple and thus user-friendly cleaning of the drill hole.
- FIS EM Plus also allows for the execution of rebar connections in diamond-drilled holes.
- The FRA with connecting thread in stainless steel A4 fully utilises the load-bearing capacity of the concrete. This means that extremely high tensile loads can be introduced into the base material.
- Accessories in line with building site requirements, such as injection adapters and extension tubes, ensure rapid progress.
- The FIS rebar case contains all of the individual components required, thus ensuring a convenient installation.

APPLICATIONS

- Post-installed concrete steel bars, e.g. for overlap connections, end anchorings, starter bars, crack stitching etc.
- Rebar anchor FRA
- Concrete-Concrete Shear Connector FCC

FUNCTIONING

- Anchoring as with cast-in reinforcement bars in line with Eurocode 2 and DIN 1045-1.
- The mortar is extruded bubble free into the drill hole using the injection adapter. The geometry causes a build-up of pressure in the drill hole, which pushes the injection adapter and extension tube automatically out of the drill hole.
- The mortar bonds the entire surface of the reinforcement bar with the drill hole wall.
- A special certification is necessary for installation according to approval in Germany. The fischer Academy offers the relevant training courses.

INSTALLATION IN CONCRETE WITH FIS EM PLUS AND HAMMER DRILLED HOLES

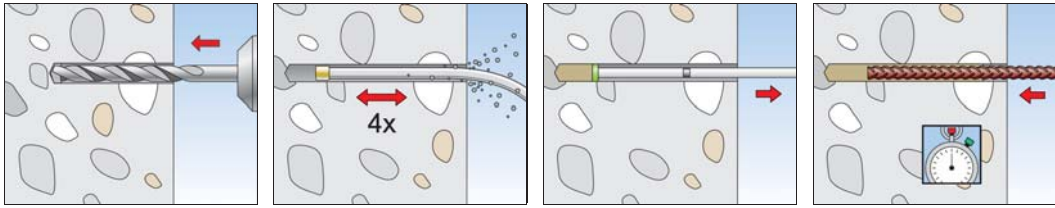

INSTALLATION IN CONCRETE WITH FIS EM PLUS IN DIAMOND DRILLED HOLES

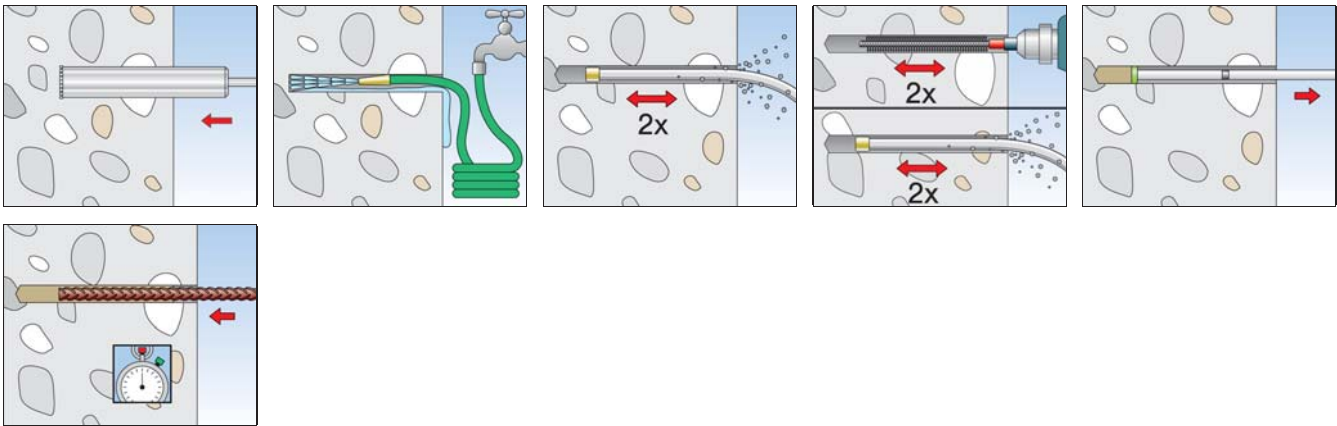

INSTALLATION IN CONCRETE WITH FIS SB IN HAMMER DRILLED HOLES

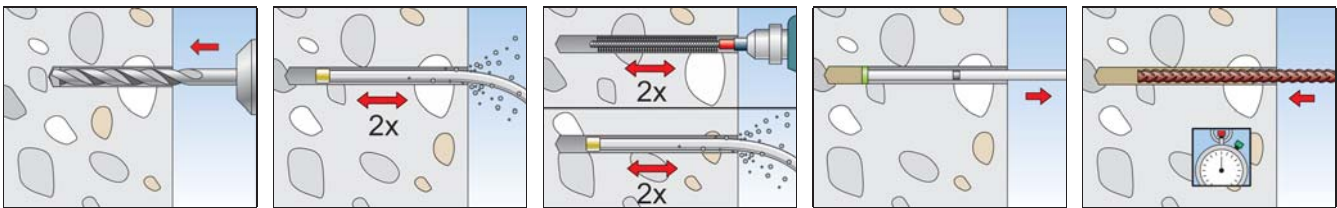

INSTALLATION IN CONCRETE WITH FIS V AND FIS VS LOW SPEED IN HAMMER DRILLED HOLES

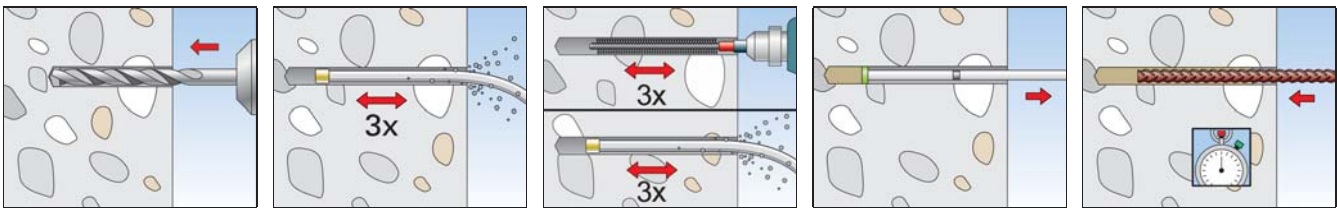

TECHNICAL DATA

 Rebar anchor FRA

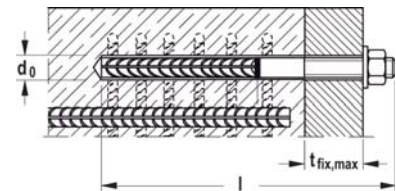

Item	Combination of materials		Approval		Total length	Max. fixing thickness	Drill hole	Fill quantity	Sales unit		
	Art.-No.		DIBt	ETA	l [mm]	t _{fix} [mm]	d ₀ [Ø mm]	[scale units]	[pcs]		
FRA 12/900 M12-60	505529	● ■	●	■	975	60	16	50	8		
FRA 16/1100 M16-60	505533	● ■	●	■	1180	60	20	81	8		
FRA 20/1400 M20-60	505534	● ■	●	■	1485	60	25	160	4		

Reinforcement bar welded with threaded part made of stainless steel A4.

TECHNICAL DATA



FIS-Rebar Case for reinforcement connection

Item	Art.-No.	Approval		Contents	Sales unit [pcs]
		DIBt	ETA		
FIS-Rebar case D	505941	●	■	8 x Cleaning brush BSB, 5 x Extensions for cleaning brushes à 40 cm, 1 x SDS Chuck with internal thread M 8, 24 x Injection adapter, 1 x Cleaning hose complete, 1 x Brush control template, 8 x Cleaning nozzle, 1 x Marker tape, 1 x Digital thermometer, 1 x Protective goggles, 1 x Installation instructions (german), 10 x Installation report, 2 x Flat spanner SW 7 and the relevant approvals	1
FIS-Rebar case Int	505942	●	■	8 x Cleaning brush BSB, 5 x Extensions for cleaning brushes à 40 cm, 1 x SDS Chuck with internal thread M 8, 24 x Injection adapter, 1 x Cleaning hose complete, 1 x Brush control template, 8 x Cleaning nozzle, 1 x Marker tape, 1 x Digital thermometer, 1 x Protective goggles, 1 x Installation instructions (german, english, french, italian, spanish), 10 x Installation report, 2 x Flat spanner SW 7 and the relevant approvals	1

ACCESSORIES

 Cleaning brush with thread M 8

Item	Art.-No.	Colour	Length [mm]	Sales unit [pcs]
BSB for drill-Ø 12 mm	001490	white	180	1
BSB for drill-Ø 14 mm	001491	blue	180	1
BSB for drill-Ø 16 mm	001492	red	180	1
BSB for drill-Ø 18 mm	001493	yellow	180	1
BSB for drill-Ø 20 mm	001494	green	180	1
BSB for drill-Ø 25 mm	001495	black	180	1
BSB for drill-Ø 30 mm	090063	grey	180	1
BSB for drill-Ø 35 mm	090071	brown	180	1
BSB for drill-Ø 40 mm	505061	-	180	1
BSB for drill-Ø 45 mm	506254	-	180	1
BSB for drill-Ø 55 mm	505062	-	180	1
FIS brush extension	508791	-	420	1
SDS Chuck	530332	-	-	1

ACCESSORIES



Injection adapter for drill Ø 12 - 25 mm



Injection adapter for drill Ø 30 - 55 mm

 Extension tube

Item	Art.-No.	Colour	Length [mm]	Sales unit [pcs]
Injection-adapter (Ø 9) for drill-Ø 12 mm	001497	ecru	-	10
Injection-adapter (Ø 9) for drill-Ø 14 mm	001498	blue	-	10
Injection-adapter (Ø 9) for drill-Ø 16 mm	001499	red	-	10
Injection-adapter (Ø 9) for drill-Ø 18 mm	001483	yellow	-	10
Injection-adapter (Ø 9) for drill-Ø 20 mm	001506	green	-	10
Injection-adapter (Ø 15) for drill-Ø 20 mm	001508	green	-	10

1) Delivery time on request.

ACCESSORIES



Injection adapter
for drill Ø 12 - 25 mm



Injection adapter
for drill Ø 30 - 55 mm

 Extension tube

Item	Art.-No.	Colour	Length [mm]	Sales unit [pcs]
Injection-adapter (Ø 9) for drill-Ø 25 mm	001507	black	-	10
Injection-adapter (Ø 15) for drill-Ø 25 mm	001509	black	-	10
Injection-adapter (Ø 9) for drill-Ø 30 mm	090689	grey	-	10
Injection-adapter (Ø 15) for drill-Ø 30 mm	090700	grey	-	10
Injection-adapter (Ø 9) for drill-Ø 35 mm	090699	brown	-	10
Injection-adapter (Ø 15) for drill-Ø 35 mm	090701	brown	-	10
Injection-adapter (Ø 9) for drill-Ø 40 mm	505077	red	-	10
Injection-adapter (Ø 15) for drill-Ø 40 mm	505079	red	-	10
Injection-adapter (Ø 9) for drill-Ø 45 mm	508909 ¹⁾	yellow	-	10
Injection-adapter (Ø 15) for drill-Ø 45 mm	508910 ¹⁾	yellow	-	10
Injection-adapter (Ø 9) for drill-Ø 55 mm	505078	ecru	-	10
Injection-adapter (Ø 15) for drill-Ø 55 mm	505080	ecru	-	10
FIS Extension tube	048983	-	1000	10
FIS EXT Ø 15	530800	transparent	10000	1

1) Delivery time on request.

ACCESSORIES



Drilling aid

Item	Art.-No.	Sales unit [pcs]
Drilling aid 3pcs.	090819	1

ACCESSORIES



SDS-max scrubbing tool to
roughen the connection surface

Item	Art.-No.	Match	Dimensions [mm]	Sales unit [pcs]
Stocker	001253	Chuck type SDS max	45 x 240	1

ACCESSORIES



Compressed air nozzle

Item	Art.-No.	Match	Sales unit [pcs]
Compressed air nozzle D12-D15	511956	Drill diameter Ø 12 - 15 mm	2
Compressed air nozzle D16-D19	511957	Drill diameter Ø 16 - 19 mm	2
Compressed air nozzle D20-D25	511958	Drill diameter Ø 20 - 25 mm	2
Compressed air nozzle D30-D35	511959	Drill diameter Ø 30 - 35 mm	2
Compressed air nozzle D40-D55	511960	Drill diameter Ø 40 - 45 mm	2

LOADS

Injection systems FIS EM Plus, FIS RC, FIS SB, FIS V and FIS VS LOW SPEED with reinforcing steel B500B⁵⁾ in accordance with rebar theory

Design resistances and permissible loads ¹⁾⁶⁾ of single, post-installed rebars in cracked or non-cracked normal concrete of the strength class C20/25 ²⁾						
Reinforcing steel B500B $f_{yk} / f_{uk} =$ 500 / 540 N/mm ²	Basic value for the anchorage length for FIS EM Plus	Basic value for the anchorage length for FIS SB	Basic value for the anchorage length for FIS V FIS VS LOW SPEED	Maximum anchorage depth	Maximum design resistance for axial tensile load	Maximum permissible tensile load
	$l_{b,rqd}^{4)}$ [mm]	$l_{b,rqd}^{4)}$ [mm]	$l_{b,rqd}^{4)}$ [Nm]	$l_{v,max}$ [mm]	$N_{Rd,s}^{3)}$ [kN]	$N_{perm,s}^{3)}$ [kN]
Ø 8 mm	378	378	378	1800 (3000) ⁸⁾	21,9	15,6
Ø 10 mm	473	473	473	1800 (3000) ⁸⁾	34,1	24,4
Ø 12 mm	567	567	567	1800 (3000) ⁸⁾	49,2	35,1
Ø 14 mm	662	662	662	1800 (3000) ⁸⁾	66,9	47,8
Ø 16 mm	756	756	756	1800 (3000) ⁸⁾	87,4	62,4
Ø 20 mm	945	945	945	1800 (3000) ⁸⁾	136,6	97,6
Ø 22 mm ⁷⁾	1040	-	-	2000	165,3	118,1
Ø 24 mm ⁷⁾	1134	-	-	2000	196,7	140,5
Ø 25 mm	1181	1181	1181	2000 (3000) ⁸⁾	213,4	152,4
Ø 26 mm ⁷⁾	1229	-	-	2000	230,8	164,9
Ø 28 mm	1323	1323	1323	2000 (3000) ⁸⁾	267,7	191,2
Ø 30 mm ⁷⁾	1418	-	-	2000	307,3	219,5
Ø 32 mm ⁹⁾	1512	1512	-	2000 (3000) ⁸⁾	349,7	249,8
Ø 34 mm ⁷⁾	1607	-	-	2000	394,7	282,0
Ø 36 mm ⁷⁾	1701	-	-	2000	442,6	316,1
Ø 40 mm ⁷⁾	1890	-	-	2000	546,4	390,3

For planning and design the complete European Technical Assessments ETA-17/1056 (FIS EM Plus), ETA-13/0651 (FIS SB) or resp. ETA-08/0266 (FIS V and FIS VS LOW SPEED) have to be considered. For determination of the installation parameters (minimum concrete cover, distances, etc.) as well as required transverse reinforcement see EN 1992-1-1 and general installation rules of the assessments.

- ¹⁾ The partial safety factors for resistance taken from the European standard EN 1992-1-1 as well as a partial safety factor for action of $\gamma_F = 1,4$ are considered.
- ²⁾ The ETAs for FIS EM Plus, FIS SB, FIS V and FIS VS LOW SPEED permit post-installed rebar connections in concrete C12/15 up to C50/60. The above mentioned basic value for anchorage length changes depending on the relevant concrete strength class.
- ³⁾ For utilisation of the full steel capacity.
- ⁴⁾ Basic value of the anchorage length in accordance with EN 1992-1-1, section 8.4.3 for concrete strength class C20/25 and good bond conditions.
- ⁵⁾ Reinforcing steel with characteristic yield strength $f_{yk} = 400 - 600$ N/mm² in accordance with EN 1992-1-1 Annex C, Table C.1 and C.2N is approved. The above mentioned basic value for the anchorage length as well as maximum steel resistance (see foot not 3) will change accordingly.
- ⁶⁾ With FIS EM Plus, FIS SB, FIS V or FIS VS LOW SPEED post-installed rebars are approved in dry or wet concrete with temperatures up to +50 °C (resp. short term up to +80 °C) and drill hole cleaning in accordance with ETA.
- ⁷⁾ Only FIS EM Plus.
- ⁸⁾ Values in brackets apply for FIS SB.
- ⁹⁾ Only FIS EM Plus or FIS SB.

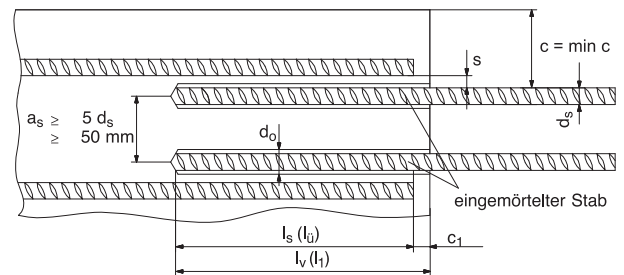
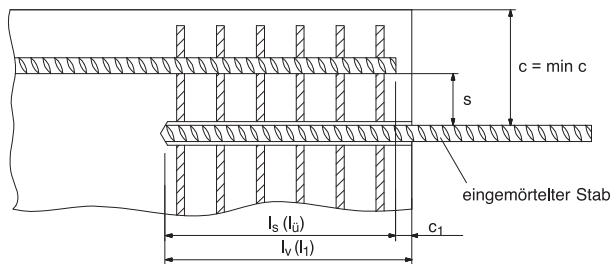

LOADS

Design resistances and permissible loads^{1) 5)} of single, post-installed Rebar anchor in cracked or non-cracked normal concrete of the strength class C20/25²⁾

Design resistances and permissible loads ^{1) 5)} of single, post-installed Rebar anchor in cracked or non-cracked normal concrete of the strength class C20/25 ²⁾						
Type	Basic value for the anchorage length $l_{b,rqd}^{4)}$ [mm]	Maximum anchorage depth $l_{v,max}$ [mm]	Maximum embedment depth $l_{e,ges,max}$ [mm]	Maximum torque moment T_{inst} [Nm]	Maximum design resistance for axial tensile load $N_{Rd,s}^{3)}$ [kN]	Maximum permissible tensile load $N_{perm,s}^{3)}$ [kN]
FRA 12/900 M12	567	800	900	≤ 50	49,2	35,1
FRA 16/1100 M16	756	1000	1100	≤ 100	87,4	62,4
FRA 20/1400 M20	945	1300	1400	≤ 150	136,6	97,6

For planning and design the complete European Technical Assessments ETA-17/1056 (FIS EM Plus), ETA-13/0651 (FIS SB) or resp. ETA-08/0266 (FIS V and FIS VS LOW SPEED) have to be considered. For determination of the installation parameters (minimum concrete cover distances, etc.) as well as required transverse reinforcement see EN 1992-1-1 and general installation rules of the assessments.

- ¹⁾ The partial safety factors for resistance taken from the European standard EN 1992-1-1 as well as a partial safety factor for action of $\gamma_F = 1,4$ are considered.
- ²⁾ The ETAs for FIS EM Plus, FIS SB, FIS V and FIS VS LOW SPEED permit post-installed rebar connections in concrete C12/15 up to C50/60. The above mentioned basic value for anchorage length changes depending on the relevant concrete strength class.
- ³⁾ For utilisation of the full steel capacity.
- ⁴⁾ Basic value of the anchorage length in accordance with EN 1992-1-1, section 8.4.3 for concrete strength class C20/25 and good bond conditions.
- ⁵⁾ With FIS EM Plus, FIS SB, FIS V or FIS VS LOW SPEED post-installed Rebar anchors are approved in dry or wet concrete with temperatures up to +50 °C (resp. short term up to +80 °C) and drill hole cleaning in accordance with ETA.

General rules of constructions

- The Rebar anchor FRA is permitted to transfer tension loads in direction of the axis of the rebar only.
- l_v and l_s according to approval.
- According to approval it has to be proved that sufficient transverse reinforcement is available.

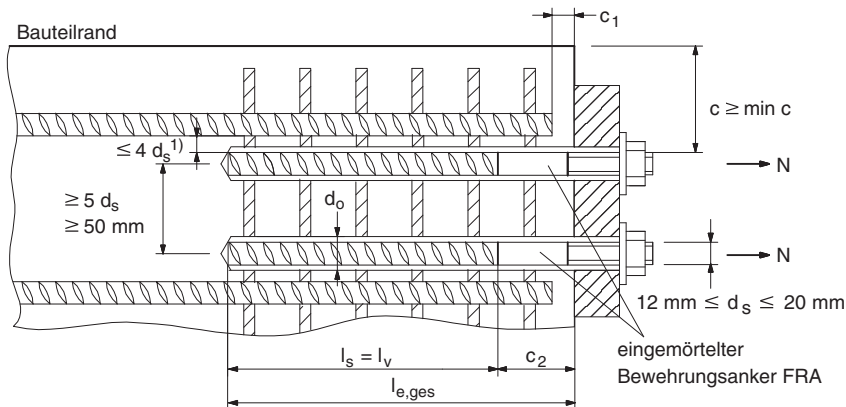

- c Concrete cover of the post-installed rebar anchor
- c₁ Concrete cover of the front side of the existing rebar
- c₂ Concrete cover above the welding
- min c Minimum concrete cover acc. to approval
- d_s Diameter of the post-installed rebar anchor
- l_s Lap length
- l_v Effective anchorage depth of the rebar anchor
- l_{e,ges} Embedment depth of the rebar anchor
- d₀ Nominal drill diameter

¹⁾ If the clear distance of the lapped bars is larger than $4 \times d_s$, EC2 has to be applied.

The approved system for building renovation

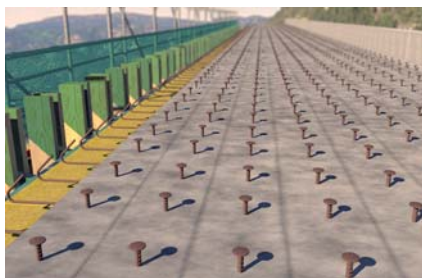

Upgrade of bridges

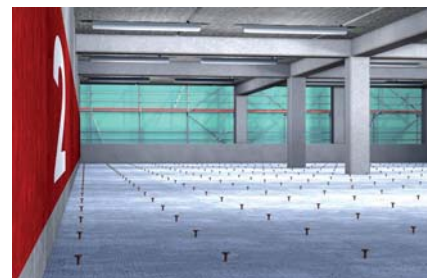

Reinforcement of ceilings

VERSIONS

- Zinc-plated concrete steel bar B500B

BUILDING MATERIALS

Approved for:

- Concrete C20/25 to C50/60, cracked and non-cracked
- Fixing in old concrete B 25 to B 55

CERTIFICATES



ADVANTAGES

- Due to its geometry and ease of installation, FCC is the rapid and economic alternative compared to the conventional installation method with bent iron.
- Dimensioning of the anchorage is possible thanks to the building approval. Thus, the system offers maximum security.
- Variable anchoring depths allow for ideal adaptation to the load to be applied, and ensure an optimised installation time and use of materials.
- Depending on site conditions, the FCC can be anchored, in compliance with the approval, with the injection mortars FIS SB or FIS EM Plus.
- In conjunction with FIS EM Plus, FCC is also approved for use in diamond-drilled drill holes.

APPLICATIONS

- Bridge repairs
- Increasing load capacity of bridges
- Increasing loads of ceilings during conversion, for example
- Reinforcement of foundations, piers, columns and walls
- Renovation of car park ceilings following corrosion damage

FUNCTIONING

- The system consists of injection mortar (FIS SB or FIS EM Plus) and the concrete-concrete shear connector FCC.
- The mortar is injected bubble-free from the drill hole base.
- The mortar adheres the drill hole wall to the shear connector FCC.
- The shear connector is set manually, by lightly rotating it until it reaches the drill hole base.
- The tensile and shear forces arising in the joints between the old and new concrete are absorbed by the FCC-H and safely redirected.

INSTALLATION IN CONCRETE WITH FIS SB OR FIS EM PLUS AND FCC-H

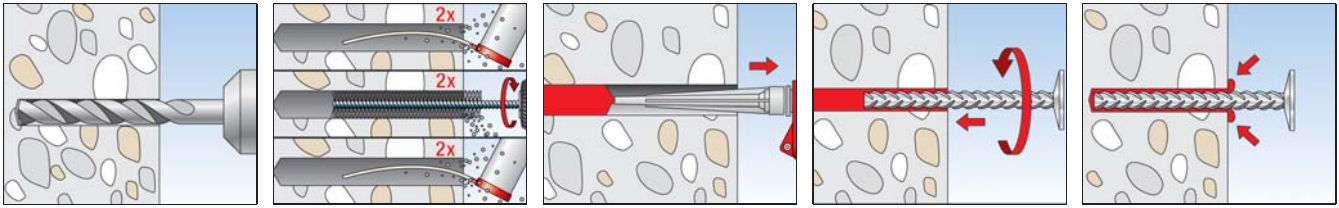

TECHNICAL DATA

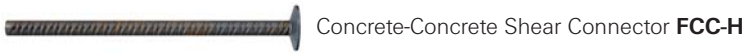

Item	Art.-No.	Approval DIBt	Drill hole diameter d_0 [mm]	Rebar diameter [mm]	Anchor length [mm]	Min. / standard anchorage depth [mm]	Min. / standard fill quantity e.g. FIS SB [scale units]	Sales unit [pcs]
FCC-H 10 x 180	520081	●	12	10	180	60/120	2/4	100
FCC-H 12 x 230	520082 ¹⁾	●	14	12	230	70/155	3/7	100
FCC-H 14 x 290	520083 ¹⁾	●	18	14	290	75/195	6/14	50
FCC-H 16 x 360	520085 ¹⁾	●	20	16	360	80/240	7/20	25

1) Delivery time on request.

The professional façade repair for two-leaf cavity walls



Repairing outer leaves



Detail: Repairing outer leaves

VERSIONS

- Stainless steel

BUILDING MATERIALS

- Facing masonry with and without an air layer

CERTIFICATES



ADVANTAGES

- The expansion-force-free fixing prevents splitting and cracks. This means that VBS 8 can be used even in old and sensitive masonry.
- The drill bit diameter of just 8 mm means that a minimal amount of mortar is required for each fixing point. Thus VBS 8 is particularly economical.
- The installation is approved anywhere along the entire bed joint, thus ensuring a high level of installation safety.
- The grey colour of the injection mortar is similar to the colour of the bed joint. This means that the fixing is almost invisible to the eye.

APPLICATIONS

- Post-installation needling of two-skin cavity walls

FUNCTIONING

- The remedial wall tie VBS 8 comprises a perforated plastic sleeve and a profiled A4 stainless steel tie Ø 4 mm.
- VBS 8 is used together with the injection mortar FIS V.
- The anchor is inserted in the bed joint of the outer leaf using push-through installation.

INSTALLATION IN FACING MASONRY WITH FIS V AND VBS 8

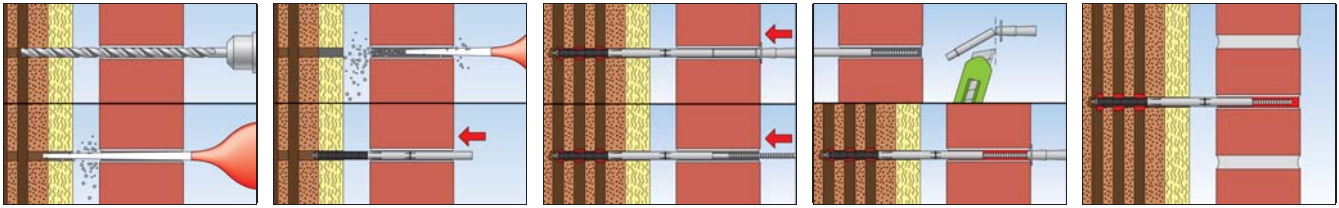

TECHNICAL DATA



Remedial wall tie **VBS 8**

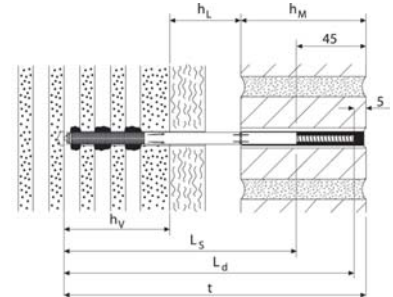

Item	Stainless steel	Approval	Cavity or insulation	Drill hole diameter	Outer leaf	Depth = embedding depth	Fixing length	Anchorage depth	Fill quantity FIS V bearing wall	Sales unit
	Art.-No.									
	A4									
VBS 8/20	078763 1)2)	●	0 - 20	8	≥ 90	195	188	>60	4	100
VBS 8/50	078799 1)2)	●	20 - 50	8	≥ 90	225	218	>60	4	100
VBS 8/80	078800 1)2)	●	50 - 80	8	≥ 90	255	248	>60	4	100
VBS 8/120	078801 1)2)	●	80 - 120	8	≥ 90	295	288	>60	6	100
VBS 8/150	078802 1)2)	●	120 - 150	8	≥ 90	325	318	>60	6	100

1) Product consisting of perforated plastic sleeve, profiled wire A4 and injection nozzle.

2) For the closing of the curtain walling about 2-3 additional scale units of mortar FISV are required.

ACCESSORIES



Compressed-air cleaning tool Hammer drill SDS-Plus Pointer, DIN 8039

Item	Art.-No.	Technical details	Sales unit
			[pcs]
VBS 8 cleaning set	090241	content: cleaning brush and extension tube for blow-out pump	1
Compressed-air cleaning tool	093286	for professional cleaning of the drill hole	1
SDS-Plus Pointer 8,0 / 460 mm	074330	Hammer drill with self-centring drill bit and relief-ground drill grooving	1

The economical solution for the repair of triple-skin outer wall panels



Repairing weather shells



Detail: Repairing weather shells

VERSIONS

- Stainless steel

BUILDING MATERIALS

- Triple-skin outer wall panels made of concrete \geq C12/15

CERTIFICATES



ADVANTAGES

- The FWS II achieves a high shear load-bearing capacity due to its large anchor diameter. This reduces the number of reconstruction anchors needed for each plate to a minimum, thus saving costs.
- The drill hole can be drilled in one step using standard diamond drill bits. This ensures quick progress is made.
- Installation is already approved from a sub-base thickness \geq 80 mm.
- Approval with a new measuring strategy allows a safer and economically static calculation while making it possible to document loads from temperature changes.

APPLICATIONS

- For post-installation securing of triple-skin outer wall panels
- Strengthening outer wall panels for additional exterior insulation

FUNCTIONING

- The FWS II weather facing reconstruction anchors can be bedded in mortar into the load-bearing skin and weather shell with the FIS V, FIS VW or FIS VS injection mortar.
- The red plastic coating protects the insulation from being penetrated with mortar.
- You can see the correct anchor filling with the weather shell through the inspection openings on the head of the anchor.

INSTALLATION IN TRIPLE-SKIN OUTER WALL PANELS WITH FIS V AND FWS II-A

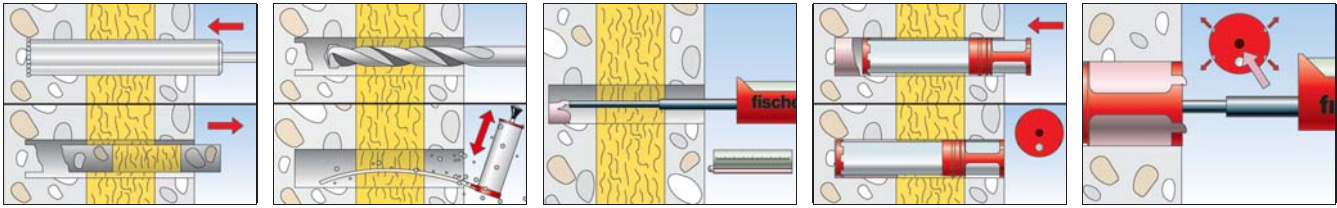

TECHNICAL DATA



Weather facing reconstruction system
FWS II - A

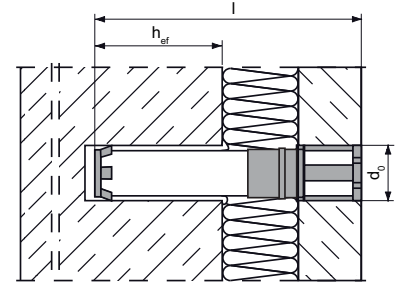

Item	Art.-No.	Approval DIBt	Total length	Nom. drill diameter	Effect. anchorage depth in the load-bearing skin	Anchors per cartridge FIS V / FIS VS / FIS VW 360 ml	Sales unit [pcs]
			l [mm]	d ₀ [mm]	h _{ef} [mm]		
FWS II - A 180	532883	●	180	40 - 41	70	5	5
FWS II - A 205	532884	●	205	40 - 41	70	5	5
FWS II - A 230	532885	●	230	40 - 41	70	5	5

TECHNICAL DATA



Injection mortar **FIS V 360 S**

Item	Art.-No.	Approval		Languages on the cartridge	Scale unit	Contents	Sales unit [pcs]
		DIBt	ETA				
FIS V 360 S	094404	●	■	DE, FR, NL, TR, HU, AR	180	1 cartridge 360 ml, 2 x FIS MR Plus	6

LOADS

Weather facing reconstruction system FWS II

Highest permissible shear loads^{1) 5)} for a single anchor in a load-bearing skin made of concrete \geq C12/15.

For the design the complete approval Z-21.8-2029 has to be considered.

Type	Effective anchorage depth in the load bearing skin h _{ef} \geq [mm]	Thickness of load-bearing layer h _T \geq [mm]	Thickness of thermal insulation ²⁾ h _D \leq [mm]	Thickness of outer leaf h _w \geq [mm]	Permissible bending moment M _{perm} [Nm]	Cracked or non-cracked concrete	
						Permissible shear load ⁴⁾ V _{perm} [kN]	Minimum edge distance ³⁾ c _{min} (c _w , c _T) [mm]
FWS II - A 180	70	80	70	40	1310	11,5	150
FWS II - A 205	70	80	95	40	1310	9,5	150
FWS II - A 230	70	80	120	40	1310	8,1	150

¹⁾ Required safety factors are considered. The given loads are valid under the pre-condition that an additional thermal insulation will be applied on the weather facing.

²⁾ For bigger insulation thicknesses special lengths are possible.

³⁾ For exact arrangement of the bolts as well as for eventually needed additional proofs see approval.

⁴⁾ The determination of the permissible shear load for special lengths is done according Annex 3 and 4 of the approval.

⁵⁾ The given loads are valid for fixations in dry and humid concrete for temperatures in the substrate up to +50 °C (resp. short term up to 80 °C) and drillhole cleaning according to approval.

The epoxy resin for repair work



Filling cracks

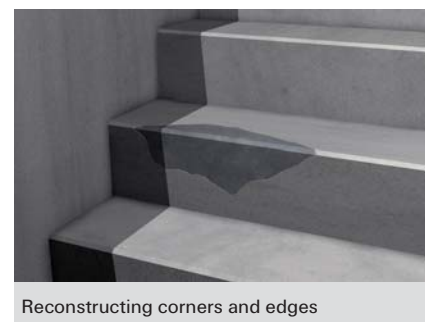

Reconstructing corners and edges

BUILDING MATERIALS

Suitable for:

- Concrete

ADVANTAGES

- The FCS based on epoxy resin has a high bond strength and a low shrinkage value. This guarantees a high performance and opens up a wide range of applications.
- The two product variants, FCS Liquid (low viscosity = liquid) and FCS (high viscosity = paste-like), allow for use both in horizontal situations and on walls and ceilings. Therefore, there is always the right product for every occasion.

APPLICATIONS

- Filling holes and cracks in concrete and similar surfaces
- Reconstructing chipped corners and edges

FUNCTIONING

- The resin and hardener are stored in two separate containers.
- The hardener is added to the resin and mixed thoroughly until the material is the same colour throughout.
- Note: The quality of the mixing of components and the proper filling of the holes (without air pockets) has an effect on the load-bearing capacity of the system!
- FCS Liquid can be poured into holes or cracks, or applied using a brush.
- FCS can be applied with a palette knife.
- Once mixed, the material can be used until the maximum open time is reached.

INSTALLATION FCS

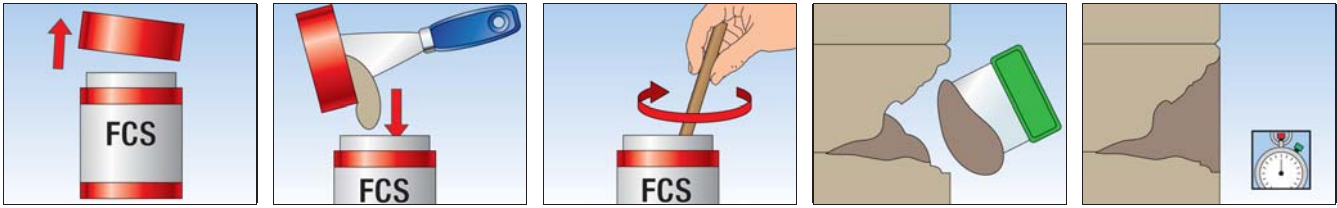

INSTALLATION FCS LIQUID



TECHNICAL DATA



fischer Can System **FCS**



fischer Can System **FCS liquid**

Item		Languages on the can	Sales unit [pcs]
FCS - fischer Can System	043676	EN, ES, PT	12
FCS Liquid - fischer Can System	043917	EN, ES, PT	12

CURING TIME

Temperature	Gelling time	Curing time
+ 5°C	70 min.	60 hrs.
+10°C	60 min.	30 hrs.
+20°C	45 min.	24 hrs.
+30°C	30 min.	20 hrs.
+40°C	15 min.	16 hrs.

The gelling time starts when the components get in contact. Stir the components thoroughly until the colour of the mortar is evenly. This is essential to achieve the full performance of the mortar.

Liquid plugs and repair compounds for serious cases



Repairing damaged drill holes



Repairing damaged hinges

BUILDING MATERIALS

- Concrete
- Vertically perforated brick
- Hollow blocks made from lightweight concrete
- Cavity floor slabs made from bricks and concrete
- Wooden materials
- Perforated sand-lime brick
- Solid sand-lime brick
- Natural stone with dense structure
- Panel building materials
- Aerated concrete
- Solid panel made from gypsum
- Solid brick made from lightweight concrete
- Solid brick

ADVANTAGES

- The Fill & Fix injection fixing works whatever the drill hole size and building material. As a result, a number of applications can be completed with just one product.
- Wood screws can be screwed directly into the hardened injection fixing. This allows for a fast and simple installation.
- Due to the special formulation, the screw can be screwed into the injection fixing and removed. Thus, components can be reattached to the same point.
- Fill & Fix can be sanded and painted, and is suitable for filling drill holes that are no longer needed prior to painting.

APPLICATIONS

- Repairing cracked or over-sized drill holes
- Repairing broken furniture hinges etc.
- Fixing lightweight objects in difficult or damaged building materials (old buildings)
- Fixing lightweight objects in internal and UV-protected external areas

FUNCTIONING

- Fill & Fix is a 2-component, solvent-free injection compound based on polyurethane. It is applied into the drill hole, where it foams lightly and sets quickly.
- The increase in volume during the setting process guarantees a secure hold, even in dilapidated or difficult building materials.
- After approx. 2 minutes, screws, hooks, eye screws etc. with a diameter of up to 6 mm that are normally used in wood can be screwed into and removed from the set material without pre-drilling.
- Use the perforated sleeves (included) for hollow and board building materials.

INSTALLATION IN SOLID BUILDING MATERIALS

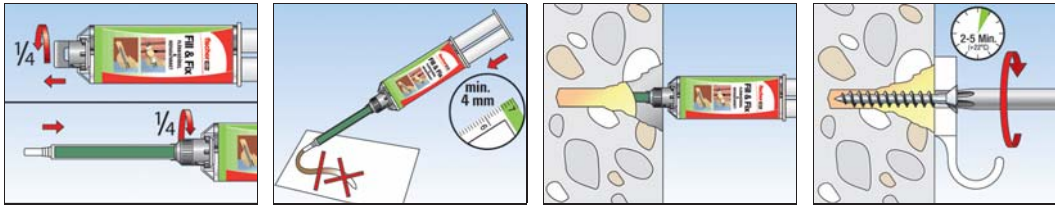

INSTALLATION IN HOLLOW AND PANEL BUILDING MATERIALS

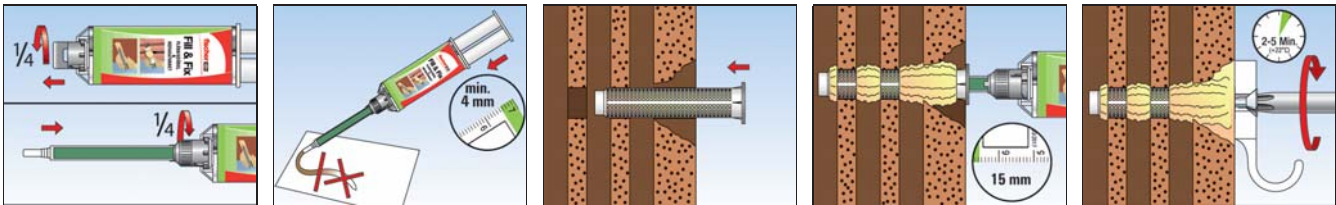

TECHNICAL DATA



Item	Art.-No.	Contents	Languages on the cartridge	Sales unit [pcs]
Fill & Fix K (D)	051097	1 cartridge 25 ml, 2 static mixer, 4 anchor sleeves, 2 extension tubes	DE	4
Fill & Fix K (D/F)	503227	1 cartridge 25 ml, 2 static mixer, 4 anchor sleeves, 2 extension tubes	D, F	8
Fill & Fix K (F)	513500	1 cartridge 25 ml, 2 static mixer, 4 anchor sleeves, 2 extension tubes	F	8
Fill & Fix K (I)	051098	1 cartridge 25 ml, 2 static mixer, 4 anchor sleeves, 2 extension tubes	I	8
Fill & Fix K (S/DK)	505083	1 cartridge 25 ml, 2 static mixer, 4 anchor sleeves, 2 extension tubes	S, DK	8
Fill & Fix K (GR)	505084	1 cartridge 25 ml, 2 static mixer, 4 anchor sleeves, 2 extension tubes	GR	8
Fill & Fix Static mixer	502735	6 static mixer	-	1

LOADS

Fill & Fix

Highest recommended loads¹⁾ for a single anchor.

The given loads are valid for chipboard screws with the specified diameters.

Type	Fill & Fix				
Diameter of chipboard screw	∅ [mm]	4,0	5,0	6,0	
Nominal drill diameter	d ₀ [mm]	10	10	10	
Anchorage depth	h _{ef} ≥ [mm]	45	45	45	
Drill hole depth	h ₁ ≥ [mm]	50	50	50	
Anchorage in solid substrates					
Recommended load ²⁾ in concrete	≥ C12/15	[kN]	0,50	0,60	0,70
Recommended load ²⁾ in sand-lime bricks	≥ KS 20 a. ≥ NF	[kN]	0,50	0,60	0,70
Anchorage in perforated bricks/hollow blocks using the perforated sleeve					
Recommended load ²⁾ in vertically perforated bricks	≥ HLz 12, ρ ≥ 0,9 kg/dm ³ a. ≥ 16DF	[kN]	0,20	0,25	0,30
Recommended load ²⁾ in per forated sand-lime bricks	≥ KSL 12, ρ ≥ 1,4 kg/dm ³ a. ≥ 5DF	[kN]	0,20	0,25	0,30
Recommended load ²⁾ in lightweight concrete hollow blocks		[kN]	0,20	0,25	0,30
Anchorage in aerated concrete					
Recommended load ²⁾ in aerated concrete	≥ PP2	[kN]	0,10	0,15	0,20
Anchorage in board materials using the perforated sleeve					
Recommended load ²⁾ in gypsum plasterboard	12,5 mm	[kN]	0,12	0,12	0,12
Recommended load ²⁾ in gypsum plasterboard	25 mm (= 2 × 12,5 mm)	[kN]	0,20	0,20	0,20
Recommended load ²⁾ in gypsum fibreboard	12,5 mm	[kN]	0,21	0,21	0,21











¹⁾ Required safety factors are considered.

²⁾ Valid for tensile load, shear load and oblique load under any angle.

Dispensers and Mortars

								Page
FIS ... 150 T	FIS ... 300 T	FIS ... 345 S	FIS ... 360 S	FIS ... 380/410 C	FIS ... 390 S	FIS ... 585 S	FIS ... 1500 S	

Dispensers / Mortars

 FIS DMS (511118)	■	■	■	■		■			196
 FIS AM (58000)	■	■	■	■		■			196
 KP M1 (53115)	■	■							196
 KP M2 (53117)	■	■							196
 FIS AC (96497)					■				196
 FIS DMS-L (510992)							■		196
 FIS DCD S (543629)		■	■	■		■			197
 FIS AP (58027)	■	■	■	■		■			197
 FIS DP-S L (511125)							■		197
 FIS DP-S XL (512401)								■	197

FIS DMS (511118)



APPLICATIONS

- Shuttle cartridges with 345, 360 and 390 ml content
- Cartridges with 150 ml content
- Multibond cartridges with 300 ml content
- Standard silicone cartridges

ADVANTAGES

- The 3-fold push rod distributes the extrusion forces equal over the cartridge and prevents the cartridge from tearing up.
- The robust glass fiber reinforced plastic housing increases the breaking strength of the dispenser and offers a long service life.
- The ergonomic design of the FIS DMS ensures a good balance and allows fatigue-free working.

FIS AM (58000)



APPLICATIONS

- Shuttle cartridges with 345, 360 and 390 ml content
- Cartridges with 150 ml content
- Multibond cartridges with 300 ml content
- Standard silicone cartridges

ADVANTAGES

- The robust design can withstand the high requirements of the job site and thus offers a long life.
- The infinitely variable feed allows the exact dosing and thus ensures easy handling.

KP M1 (53115)



APPLICATIONS

- Cartridges with 150 ml content
- Multibond cartridges with 300 ml content
- Standard silicone cartridges

ADVANTAGES

- The handy, robust solid metal construction for standard cartridges up to 310 ml bears up against requirements on the construction site and, as such, is also suitable for professional use.
- The continuous in-feed allows for a precise dosage, making it easy to use.
- The slim shape of the device allows for an exact application, even in difficult to reach spots, thus offering a high level of flexibility

KP M2 (53117)



APPLICATIONS

- Cartridges with 150 ml content
- Multibond cartridges with 300 ml content
- Standard silicone cartridges

ADVANTAGES

- The 18:1 transmission ratio enables the fast, low-energy application of even highly viscous materials, thus ensuring stress-free work.
- The robust design with the special, hardened drive block meets the tough requirements of a construction site and thus offers a long lifespan.
- The freely accessible cartridge makes it possible to perfectly align the extrusion nozzle, guaranteeing application-orientated work.

FIS AC (96497)



APPLICATIONS

- Coaxial cartridges with 380 and 410 ml content

ADVANTAGES

- The robust design can withstand the high requirements of the job site and thus offers a long life.
- The infinitely variable feed allows the exact dosing and thus ensures easy handling.

FIS DMS-L (510992)



APPLICATIONS

- Cartridges with 585 ml content

ADVANTAGES

- The patented parallel lever of the FIS DM S-L allows a large and even force transmission and ensures fatigue-free working.
- The dropout protection on the cartridge holder provides a secure hold of the cartridge in the dispenser.

FIS DCD S (543629)



APPLICATIONS

- Shuttle cartridges with 345, 360 and 390 ml content
- Multibond cartridges with 300 ml content

ADVANTAGES

- The FIS DCD S has a dosing function which is controlled by a setting wheel. This allows for optimal adaptation to the processing conditions and ensures fast work progress.
- The robust battery dispenser is very light, fits comfortably in the hand and allows fatigue-free working.

FIS AP (58027)



APPLICATIONS

- Shuttle cartridges with 345, 360 and 390 ml content
- Cartridges with 150 ml content
- Multibond cartridges with 300 ml content
- Standard silicone cartridges

ADVANTAGES

- The fast venting minimises cartridge after-run, which facilitates clean work at the site.
- The reducing valve in the handle enables the optimum adjustment of the volume flow in line with the processing conditions.
- Due to the ergonomically formed handle, the dispensers fit nicely in your hand and make work less tiring.

FIS DP-S L (511125)



APPLICATIONS

- Cartridges with 585 ml content

ADVANTAGES

- The fast venting minimises cartridge after-run, which facilitates clean work at the site.
- The reducing valve in the handle enables the optimum adjustment of the volume flow in line with the processing conditions.
- Due to the ergonomically formed handle, the dispensers fit nicely in your hand and make work less tiring.

FIS DP-S XL (512401)



APPLICATIONS

- Cartridges with 1500 ml content

ADVANTAGES

- The fast venting minimises cartridge after-run, which facilitates clean work at the site.
- The reducing valve in the handle enables the optimum adjustment of the volume flow in line with the processing conditions.
- Due to the ergonomically formed handle, the dispensers fit nicely in your hand.
- In addition the dispenser has a carrying strap around which make work less tiring.

ACCESSORIES DRILL HOLE CLEANING

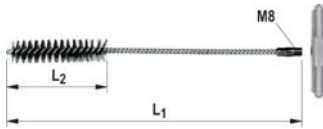

Cleaning brush **BS**



SDS-Adapter M8

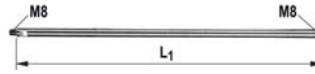

Brush extension

Item	Art.-No.	Length L1	Length L2	Brush diameter	For drill diameter	Sales unit
		[mm]	[mm]	[mm]	[mm]	[pcs]
BS ø 8	078177	120	50	9	8	1
BS ø 10	078178	120	50	11	10	1
BS ø 12	078179	150	80	13	12	1
BS ø 14	078180	250	80	16	14	1
BS ø 16/18	078181	250	80	20	16/18	1
BS ø 20/22	052277	180	80	25	20/22	1
BS ø 24	078182	300	100	26	24	1
BS ø 25	097806	300	100	27	25	1
FIS brush extension	508791	410	-	-	-	1
Compressed air nozzle D16-D19	511957	-	-	-	-	2
Compressed air nozzle D20-D25	511958 1)	-	-	-	-	2

1) Delivery time on request.

3
Chemical fixings



Compressed-air cleaning tool



Blow-out pump **AB G**



Centring wedge

Item	Art.-No.	Contents	Total length [mm]
Compressed-air cleaning tool	093286	-	-
Blow-out pump AB G	089300	-	370
Centring wedge	093076	10 wedges for overhead installation, from M16	-

ACCESSORIES



Machine setting tool **RA-SDS**



Adapter **SDS plus 1/2" VK**



Adapter **SDS max 1/2" VK**



Adapter **SK SW 8 1/2" VK**



Adapter **SDS max 3/4" VK**

Item	Art.-No.	Match	Sales unit [pcs]
RA-SDS	062420	Adapter suitable fits set screw	1
SK SW 8 1/2	001536	Adapter suitable fits threaded rods M8 - M22	1
SDS plus 1/2	001537	Adapter suitable fits threaded rods M8 - M16	1
SDS max 1/2	001538	Adapter suitable fits threaded rods M16 - M20	1
SDS max 3/4	001539	Adapter suitable fits threaded rods M20 - M30	1

SETTING TOOLS

Setting tool with SDS adapter

For simple installation of bonded anchors for example Resin anchor RM II, Highbond anchor FHB II, Superbond resin capsule RSB.

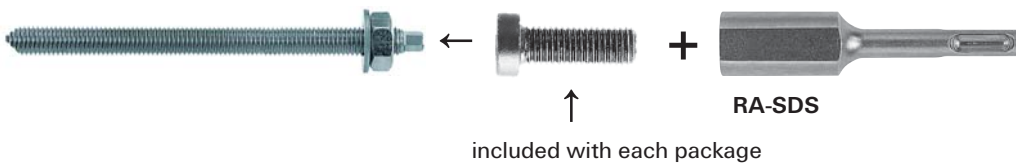

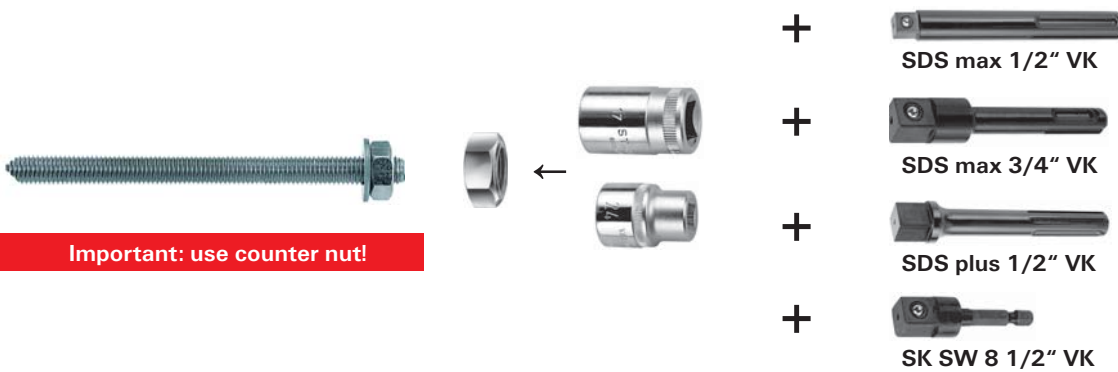

Adapter for installing threaded rods

Threaded rods without external hex-drive (special lengths).

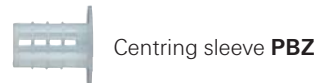

ACCESSORIES

















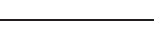
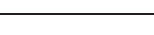



Item	Art.-No.	Approval	Match	Contents	Sales unit [pcs]
Cone drill PBB	090634		M8 - M12; FIS E	1x cone drill PBB	1
Centring sleeve PBZ	090671		M8 - M12; FIS E	10x centring sleeve PBZ, 5x injection adapter	10



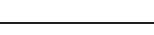

4 High performance steel anchors

		Page
Bolt anchor FAZ II		202
High performance anchor FH II		209
High performance anchor FH II-I		217
ZYKON undercut anchor FZA		220
ZYKON hammerset anchor FZEA II		228
Concrete screw ULTRACUT FBS II 8-14		232
Concrete screw ULTRACUT FBS II 6		242
Hammerset anchor EA II		247
Hammerset anchor EA-N		252
Nail anchor FNA II		256
Nail anchor FNA II RB		260
Ceiling nail FDN II		263
Ceiling nail FDZ		265
Bolt anchor FBN II		267
Heavy-duty anchor TA M		272
Heavy-duty anchor TA M-T		276
Sleeve anchor FSA		278
Fixing set for Diamond Drills FDBB		281
Wall screw MR		283
Hollow-ceiling anchor FHY		285
Aircrete anchor FPX-I		288

For highest demands. Powerful and flexible.

High performance steel anchors 4

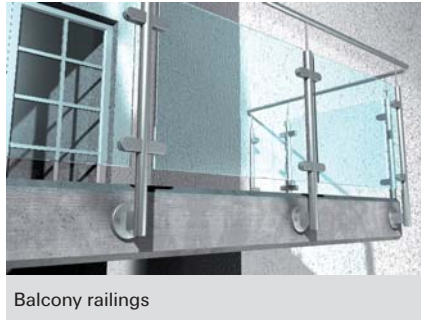

Balcony railings

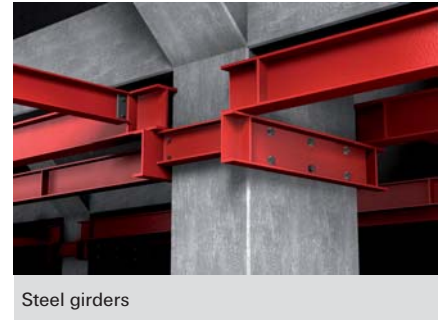

Steel girders

VERSIONS

- Zinc-plated steel
- Stainless steel
- Highly corrosion-resistant steel

BUILDING MATERIALS

Approved for:

- Concrete C20/25 to C50/60, cracked and non-cracked

Also suitable for:

- Concrete C12/15
- Concrete C80/95
- Natural stone with dense structure

CERTIFICATES

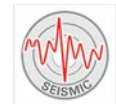

ADVANTAGES

- According to the new assessment (ETA) the tensile load capacities are decisively increased. This requires less anchors.
- The variable anchorage depths for the sizes M8 to M16 allow for the first time a millimeter-accurate adjustment to the loads.
- The design with cap nut offers a visually attractive anchoring and protects against injuries due to the round head shape.
- The first bolt anchor M6 with ETA Assessment for Option 1, for secure and approved anchorage.
- The international approvals guarantees maximum safety and the best performance.
- Approved for diamond-drilled holes.

APPLICATIONS

- Steel constructions
- Guard rails
- Consoles
- Ladders
- Cable trays
- Machines
- Staircases
- Gates
- Façades
- Timber constructions

FUNCTIONING

- The FAZ II is suitable for pre-positioned and push-through installation and is also ideal for stand-off installation thanks to the long thread.
- When applying the torque, the cone bolt is pulled into the expansion sleeve and expand it against the drill hole wall.
- The anchor is set in line with the approval once the preset installation torque is achieved.
- In the case of series installation, we recommend using the FABS anchor bolt setting tool.

DRILL HOLE PREPARATION

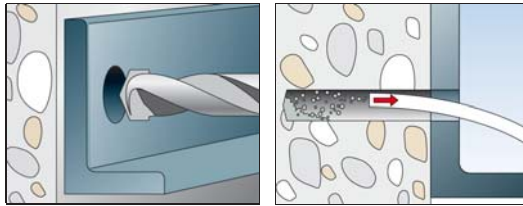

PUSH-THROUGH INSTALLATION WITH HEXAGON NUT

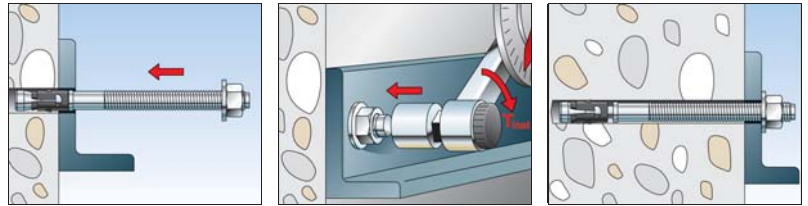

PUSH-THROUGH INSTALLATION OF THE CUP NUT VERSION WITH SETTING GAUGE

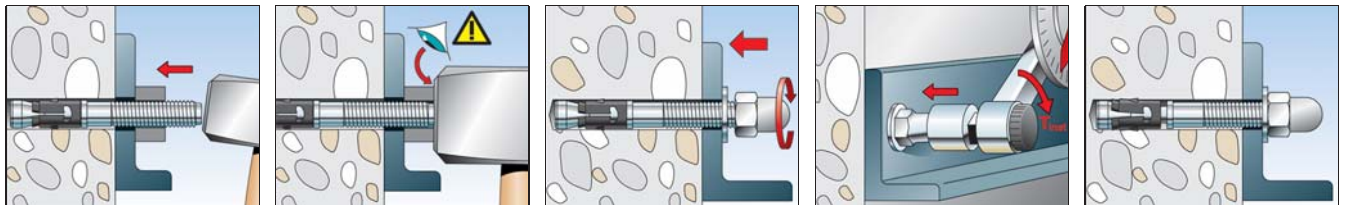

TECHNICAL DATA



Bolt anchor FAZ II

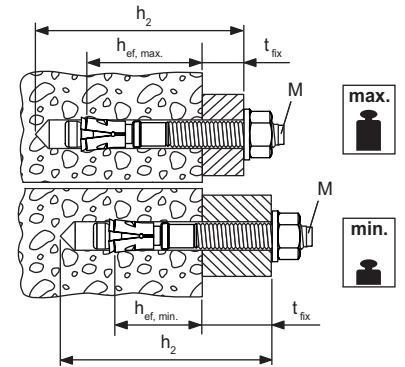

Item	Zinc-plated steel	Stainless steel	Highly corrosion resistant steel	Approval		Seismic-Approval	Drill hole diameter d_0 [mm]	Min. drill hole depth for through fixings h_2 [mm]	Anchor length l [mm]	Max. usable length $hef,max./hef,min.$ t_{fix} [mm]	Thread $\emptyset \times$ length [mm]	Width across nut \emptyset SW [mm]	Sales unit [pcs]
	Art.-No.	Art.-No.	Art.-No.	ETA	ICC								
	gvz	A4	C										
FAZ II 6/10	542621	542623	—	■	—	—	6	60	65	10/-	M 6 x 25	10	50
FAZ II 6/20	542622	542624	—	■	—	—	6	70	75	20/-	M 6 x 35	10	50
FAZ II 8/10	094871 1)	501396 1)	—	■	▲	C1	8	65	75	10/20	M 8 x 38	13	50
FAZ II 8/10	—	—	501428 1)	■	▲	C1	8	65	75	10/20	M 8 x 38	13	10
FAZ II 8/30	094877 1)	501399 1)	—	■	▲	C1	8	85	95	30/40	M 8 x 58	13	50
FAZ II 8/30	—	—	501429 1)	■	▲	C1	8	85	95	30/40	M 8 x 58	13	10
FAZ II 8/50	094878 1)	501401	—	■	▲	C1	8	105	115	50/60	M 8 x 78	13	50
FAZ II 8/100	094879 1)	—	—	■	▲	C1	8	155	165	100/110	M 8 x 128	13	25
FAZ II 8/160	503251 1)	—	—	■	▲	C1	8	215	225	160/170	M 8 x 100	13	20
FAZ II 10/10	094981	501403	—	■	▲	C1 / C2	10	85	95	10/30	M 10 x 53	17	50
FAZ II 10/10	—	—	501430	■	▲	C1	10	85	95	10/30	M 10 x 53	17	10
FAZ II 10/20	094982	—	—	■	▲	C1 / C2	10	95	105	20/40	M 10 x 63	17	25
FAZ II 10/20	—	501406	—	■	▲	C1 / C2	10	95	105	20/40	M 10 x 63	17	50
FAZ II 10/30	094983	—	—	■	▲	C1 / C2	10	105	115	30/50	M 10 x 73	17	25
FAZ II 10/30	—	501407	—	■	▲	C1 / C2	10	105	115	30/50	M 10 x 73	17	50
FAZ II 10/30	—	—	503185	■	▲	C1	10	105	115	30/50	M 10 x 73	17	10
FAZ II 10/50	094984	501409	—	■	▲	C1 / C2	10	125	135	50/70	M 10 x 93	17	20
FAZ II 10/70	—	501410	—	■	▲	C1 / C2	10	145	155	70/90	M 10 x 113	17	20
FAZ II 10/80	094985	—	—	■	▲	C1 / C2	10	155	165	80/100	M 10 x 123	17	20
FAZ II 10/100	—	501411	—	■	▲	C1 / C2	10	175	185	100/120	M 10 x 100	17	20
FAZ II 10/100	094986	—	—	■	▲	C1 / C2	10	175	185	100/120	M 10 x 143	17	20
FAZ II 10/160	—	501412	—	■	▲	—	10	235	245	160/180	M 10 x 100	17	20
FAZ II 10/160	503252	—	—	■	▲	—	10	235	245	160/180	M 10 x 193	17	20
FAZ II 12/10	095419	501413	—	■	▲	C1 / C2	12	100	110	10/30	M 12 x 61	19	20

1) With minimum embedment depth only for statically indeterminate systems

Approval Seismic C1/C2 only with maximum embedment depth

TECHNICAL DATA



Bolt anchor **FAZ II**

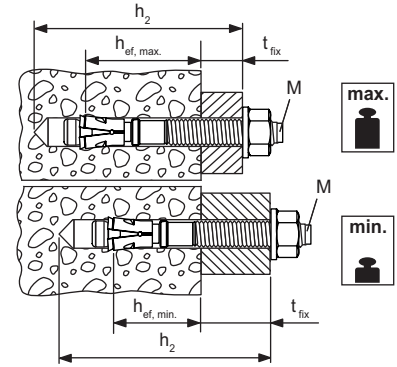

High performance steel anchors 4

Item	Zinc-plated steel	Stainless steel	Highly corrosion resistant steel	Approval		Seismic-Approval	Drill hole diameter	Min. drill hole depth for through fixings	Anchor length	Max. usable length hef,max./hef,min.	Thread	Width across nut	Sales unit
	Art.-No.	Art.-No.	Art.-No.	ETA	ICC		d ₀ [mm]	h ₂ [mm]	l [mm]	t _{fix} [mm]	∅ x length [mm]	○ SW [mm]	[pcs]
FAZ II 12/10	—	—	503186	■	▲	C1	12	100	110	10/30	M 12 x 61	19	10
FAZ II 12/20	095420	501415	—	■	▲	C1 / C2	12	110	120	20/40	M 12 x 71	19	20
FAZ II 12/30	095421	501416	—	■	▲	C1 / C2	12	120	130	30/50	M 12 x 81	19	20
FAZ II 12/30	—	—	501431	■	▲	C1	12	120	130	30/50	M 12 x 81	19	10
FAZ II 12/50	095446	501419	—	■	▲	C1 / C2	12	140	150	50/70	M 12 x 101	19	20
FAZ II 12/60	—	501420	—	■	▲	C1 / C2	12	150	160	60/80	M 12 x 111	19	20
FAZ II 12/80	095454	—	—	■	▲	C1 / C2	12	170	180	80/100	M 12 x 131	19	20
FAZ II 12/100	095470	501421	—	■	▲	C1 / C2	12	190	200	100/120	M 12 x 151	19	20
FAZ II 12/160	503253	—	—	■	▲	—	12	250	260	160/180	M 12 x 186	19	10
FAZ II 12/160	—	503180	—	■	▲	—	12	250	260	160/180	M 12 x 100	19	20
FAZ II 12/200	095605	—	—	■	▲	—	12	290	300	200/220	M 12 x 186	19	10
FAZ II 16/5	522124	—	—	■	▲	C1 / C2	16	115	128	5/25	M 16 x 64	24	10
FAZ II 16/5	—	522125	—	■	▲	C1 / C2	16	115	128	5/25	M 16 x 64	24	20
FAZ II 16/25	—	501423	—	■	▲	C1 / C2	16	135	148	25/45	M 16 x 84	24	20
FAZ II 16/25	—	—	501432	■	▲	C1	16	135	148	25/45	M 16 x 84	24	10
FAZ II 16/25	095836	—	—	■	▲	C1 / C2	16	135	148	25/45	M 16 x 84	24	10
FAZ II 16/50	095864	—	—	■	▲	C1 / C2	16	160	173	50/70	M 16 x 109	24	10
FAZ II 16/50	—	—	503187	■	▲	C1	16	160	173	50/70	M 16 x 109	24	10
FAZ II 16/50	—	501424	—	■	▲	C1 / C2	16	160	173	50/70	M 16 x 109	24	20
FAZ II 16/100	095865	501425	—	■	▲	C1 / C2	16	210	223	100/120	M 16 x 159	24	10
FAZ II 16/160	503254	—	—	■	▲	C1 / C2	16	270	283	160/180	M 16 x 189	24	10
FAZ II 16/200	095967	—	—	■	▲	—	16	310	323	200/220	M 16 x 189	24	10
FAZ II 16/250	095968	—	—	■	▲	—	16	360	373	250/270	M 16 x 100	24	10
FAZ II 16/300	096188	—	—	■	▲	—	16	410	423	300/320	M 16 x 100	24	10
FAZ II 20/30	046632	—	—	■	▲	C1 / C2	20	155	172	30/-	M 20 x 54	30	5
FAZ II 20/30	—	501426	—	■	▲	C1 / C2	20	155	172	30/-	M 20 x 54	30	4
FAZ II 20/60	046633	—	—	■	▲	C1 / C2	20	185	202	60/-	M 20 x 84	30	5
FAZ II 20/60	—	503183	—	■	▲	C1 / C2	20	185	202	60/-	M 20 x 84	30	4
FAZ II 20/160	503255	—	—	■	▲	C1 / C2	20	285	302	160/-	M 20 x 100	30	5
FAZ II 24/30	046635	—	—	■	▲	C1	24	185	205	30/-	M 24 x 58	36	5
FAZ II 24/30	—	501427	—	■	▲	C1	24	185	205	30/-	M 24 x 58	36	4
FAZ II 24/60	046636	—	—	■	▲	C1	24	215	235	60/-	M 24 x 88	36	5
FAZ II 24/60	—	503184	—	■	▲	C1	24	215	235	60/-	M 24 x 88	36	4

1) With minimum embedment depth only for statically indeterminate systems

Approval Seismic C1/C2 only with maximum embedment depth

TECHNICAL DATA



Bolt anchor **FAZ II H**

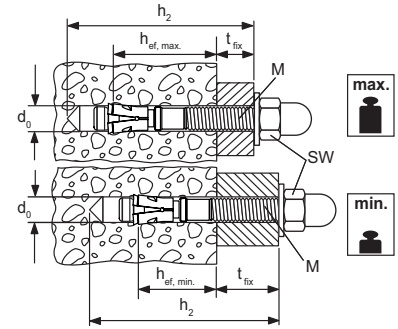

Item	Zinc-plated steel	Stainless steel	Approval		Seismic-Approval	Drill hole diameter d_0 [mm]	Min. drill hole depth for through fixings h_2 [mm]	Anchor length l [mm]	Max. usable length hef,max./hef,min. t_{fix} [mm]	Thread $\emptyset \times$ length [mm]	Width across nut \bigcirc SW [mm]	Sales unit [pcs]
	Art.-No.	Art.-No.	ETA	ICC								
	gvz	A4										
FAZ II 10/10 H	543392	543396	■	—	C1 / C2	10	87	95	10/30	M 10 x 53	17	20
FAZ II 10/20 H	543393	543397	■	—	C1 / C2	10	97	105	20/40	M 10 x 63	17	20
FAZ II 12/10 H	543394	543398	■	—	C1 / C2	12	99	109	10/30	M 12 x 61	19	20
FAZ II 12/20 H	543395	543399	■	—	C1 / C2	12	109	119	20/40	M 12 x 71	19	20

Approval Seismic C1/C2 only with maximum embedment depth

TECHNICAL DATA



Bolt anchor **FAZ II K**

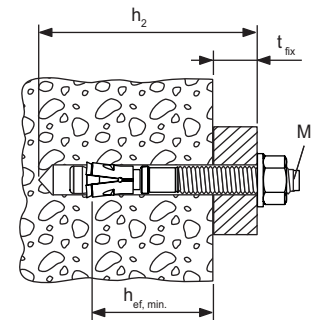

Item	Zinc-plated steel	Stainless steel	Approval	Drill hole diameter d_0 [mm]	Min. drill hole depth for through fixings h_2 [mm]	Anchor length l [mm]	Usable length (hef min.) t_{fix} [mm]	Thread $\emptyset \times$ length [mm]	Washer (outer diameter x thickness) [mm]	Sales unit [pcs]
	Art.-No.	Art.-No.								
	gvz	A4								
FAZ II 8/5 K	538989	538990	■	8	45	60	5	M 8 x 23	16 x 1,6	50
FAZ II 10/10 K	522108	522116	■	10	65	75	10	M 10 x 33	20 x 2	50
FAZ II 10/20 K	522110	—	■	10	75	85	20	M 10 x 43	20 x 2	25
FAZ II 10/20 K	—	522117	■	10	75	85	20	M 10 x 43	20 x 2	50
FAZ II 12/10 K	522118	522122	■	12	80	90	10	M 12 x 41	24 x 2,5	20
FAZ II 12/20 K	522119	522123	■	12	90	100	20	M 12 x 51	24 x 2,5	20
FAZ II 10/10 K GS	522115	—	■	10	65	75	10	M 10 x 33	25 x 3	50
FAZ II 12/10 K GS	522121	—	■	12	80	90	10	M 12 x 41	30 x 3	20

TECHNICAL DATA



Bolt anchor **FAZ II GS** (with large washer)

Bolt anchor **FAZ II HBS** (washer compliant to wood construction standard DIN 1052)

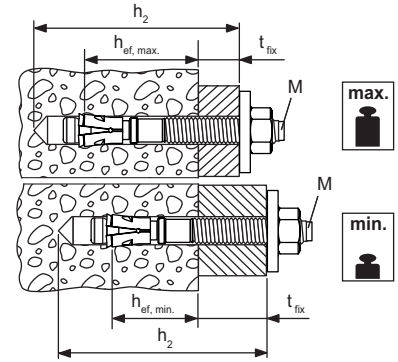

High performance steel anchors 4

Item	Steel, zinc-plated, with large washer	Stainless steel, with large washer	Approval	Seismic-Approval	Drill hole diameter	Min. drill hole depth for through fixings	Anchor length	Max. usable length hef,max./hef,min.	Thread	Width across nut	Washer (outer diameter x thickness)	Sales unit
	Art.-No.	Art.-No.										
	Art.-No.	Art.-No.	ETA		d_0 [mm]	h_2 [mm]	l [mm]	t_{fix} [mm]	$\varnothing \times$ length [mm]	\varnothing SW [mm]	[mm]	[mm]
Item	gvsz	A4										
FAZ II 8/10 GS	094872	501398	■	C1	8	65	75	10/20	M 8 x 38	13	22 x 2,5	50
FAZ II 8/30 GS	096189	501400	■	C1	8	85	95	30/40	M 8 x 58	13	22 x 2,5	50
FAZ II 10/10 GS	096291	501405	■	C1 / C2	10	85	95	10/30	M 10 x 53	17	25 x 3	50
FAZ II 10/30 GS	096297	—	■	C1 / C2	10	105	115	30/50	M 10 x 73	17	25 x 3	25
FAZ II 10/30 GS	—	501408	■	C1 / C2	10	105	115	30/50	M 10 x 73	17	25 x 3	50
FAZ II 12/10 GS	096303	501414	■	C1 / C2	12	100	110	10/30	M 12 x 61	19	30 x 3	20
FAZ II 12/20 GS	502530	—	■	C1 / C2	12	110	120	20/40	M 12 x 71	19	30 x 3	20
FAZ II 12/30 GS	096340	501418	■	C1 / C2	12	120	130	30/50	M 12 x 81	19	30 x 3	20
FAZ II 12/50 GS	502531	—	■	C1 / C2	12	140	150	50/70	M 12 x 101	19	30 x 3	20
FAZ II 12/80 GS	538430	—	■	C1 / C2	12	170	180	80/100	M 12 x 131	19	44 x 4	20
FAZ II 12/100 GS	502532	—	■	C1 / C2	12	190	200	100/120	M 12 x 151	19	30 x 3	20
FAZ II 12/100 GS	538702	—	■	C1 / C2	12	190	200	100/120	M 12 x 151	19	44 x 4	20
FAZ II 12/120 GS	096367	—	■	C1 / C2	12	210	220	120/140	M 12 x 171	19	30 x 3	20
FAZ II 12/120 GS	538703	—	■	C1 / C2	12	210	220	120/140	M 12 x 171	19	44 x 4	20
FAZ II 12/140 GS	538433	—	■	C1 / C2	12	230	240	140/160	M 12 x 186	19	44 x 4	20
FAZ II 12/160 GS	538431	—	■	C1 / C2	12	250	260	160/180	M 12 x 186	19	44 x 4	20
FAZ II 12/160 GS	—	503181	■	—	12	250	260	160/180	M 12 x 186	19	44 x 4	20
FAZ II 12/180 GS	538434	—	■	C1 / C2	12	270	280	180/200	M 12 x 186	19	44 x 4	20
FAZ II 12/200 GS	538432	—	■	C1 / C2	12	290	300	200/220	M 12 x 186	19	44 x 4	20
FAZ II 16/160 GS	503261	—	■	C1 / C2	16	270	283	160/180	M 16 x 189	24	56 x 5	10
FAZ II 16/160 GS	—	503182	■	C1 / C2	16	270	283	160/180	M 16 x 100	24	56 x 5	4
FAZ II 16/200 GS	096370	—	■	—	16	310	323	200/220	M 16 x 189	24	56 x 5	10
FAZ II 12/100 HBS	522951	—	■	C1 / C2	12	190	205	100/120	M 12 x 151	19	58 x 6	20
FAZ II 12/120 HBS	522952	—	■	C1 / C2	12	210	225	120/140	M 12 x 171	19	58 x 6	20
FAZ II 16/160 HBS	522953	—	■	C1 / C2	16	270	278	160/180	M 16 x 189	24	68 x 6	10
FAZ II 16/200 HBS	522954	—	■	—	16	310	328	200/220	M 16 x 189	24	68 x 6	10

ACCESSORIES

 fischer Anchor bolt setting tool **FABS**

Item	Art.-No.	Matching anchor type	Sales unit [pcs]
FABS	077937	FAZ II, FBZ, FBN II for diameter from M8 - M12	1

LOADS

Bolt anchor FAZ II, FAZ II K and FAZ II GS (HBS)

zinc plated steel / stainless steel / high corrosion resistant steel

Permissible loads of a single anchor in cracked normal concrete (concrete tension zone) of strength class C20/25 (~B25) ^{1) 2) 3) 9)}										Minimum spacings while reducing the load					
Type	Material fixing element	Min. member thickness	Effective anchorage depth	Installation torque	Permissible tensile load	Permissible shear load	Required edge distance (with one edge) for		Required spacing for	Min. spacing	Min. edge distance				
							Max. tension load c	Max. shear load c				Max. Load s	s _{min} ⁷⁾	c _{min} ⁷⁾	
		h _{min} [mm]	h _{ef} ⁴⁾ [mm]	T _{inst} [Nm]	N _{perm} ⁶⁾ [kN]	V _{perm} ⁶⁾ [kN]									
FAZ II 6	gvz	80	40	8	0,7	3,4	45	80	120	35	45				
	A4					5,0		125							
	C														
FAZ II 8	gvz	80	35 ⁵⁾	20	2,6	7,8	40	200	105	35	40				
		90	45		3,8		45	185	135						
	A4	80	35 ⁵⁾		2,6	8,9	40	235	105						
		90	45		3,8	9,6	45		135						
	C	80	35 ⁵⁾		2,6	8,9	40		105						
		90	45		3,8	9,6	45		135						
	FAZ II 10	gvz	90		40	45	4,3	11,3	60			275	120	40	45
			110		60		6,2	12,2	65			255	180		
A4		90	40	4,3	11,3		60	275	120						
		110	60	6,2	15,1		65	325	180						
C		90	40	4,3	11,3		60	275	120						
		110	60	6,2	15,1		65	325	180						
FAZ II 12	gvz	100	50	60	6,1	17,5	75	400	150	50	55				
		120	70		9,5		100	350	210						
	A4	100	50		6,1	18,8	75	435	150						
		120	70		9,5	21,9	100	450	210						
	C	100	50		6,1	18,8	75	435	150						
		120	70		9,5	21,9	100	450	210						
FAZ II 16	gvz	140	65	110	9,0	28,7	100	545	195	65	65				
			85		13,4	31,4	130	585	255						
	A4		65		9,0	28,7	100	545	195						
			85		13,4	39,9	130	760	255						
	C		65		9,0	28,7	100	545	195						
			85		13,4	39,9	130	760	255						
FAZ II 20	gvz	170	100	200	17,1	44,6	150	745	300	95	85				
	A4														
	C														
FAZ II 24	gvz	210	125	270	24,0	57,5	170	840	375	100	100				
	A4														
	C														

For the design the complete assessment ETA-05/0069, issue date 03.07.2017 has to be considered.⁹⁾

¹⁾ The partial safety factors for material resistance as regulated in the ETA as well as a partial safety factor for load actions of $\gamma_L = 1,4$ are considered. As an single anchor under tension load and shear load without edge influence counts e.g. an anchor with a spacing $s \geq 3 \cdot h_{ef}$ and an edge distance $c \geq 1,5 \cdot h_{ef}$. Concerning shear loads under edge influence and accurate data see ETA.

²⁾ For higher concrete strength classes up to C50/60 higher permissible loads may be possible.

³⁾ Drill method hammer drilling, hollow drilling resp. Diamond drilling.

⁴⁾ Eff. anchorage depth: min. anchorage depth, max. anchorage depth.

⁵⁾ The anchorage depths smaller than 40 mm are only allowed for single anchors as part of a multiple fixing of non-structural systems.

⁶⁾ For combinations of tensile loads, shear loads, bending moments as well as reduced edge distances or spacings (anchor groups) see ETA.

⁷⁾ Minimum possible axial spacings resp. edge distance while reducing the permissible load.

⁸⁾ The given loads refer to the European Technical Assessment ETA-05/0069, issue date 03.07.2017. Design of the loads according TR055/ETAG 001, Annex C, Method A (for static resp. quasi-static loads).

⁹⁾ A reinforcement in the concrete to prevent splitting is required. The width of the cracks has to be limited under consideration of the splitting forces at $w_k \sim 0,3\text{mm}$.

LOADS

Bolt anchor FAZ II, FAZ II K and FAZ II GS (HBS)

zinc plated steel / stainless steel / high corrosion resistant steel

Permissible loads of a single anchor in non-cracked normal concrete (concrete compression zone) of strength class C20/25 (~B25) ^{1) 2) 3)}										Minimum spacings while reducing the load	
Type	Material fixing element	Min. member thickness h_{min} [mm]	Effective anchorage depth $h_{ef}^{4)}$ [mm]	Installation torque T_{inst} [Nm]	Permissible tensile load $N_{perm}^{6)}$ [kN]	Permissible shear load $V_{perm}^{6)}$ [kN]	Required edge distance (with one edge) for		Required spacing for Max. Load s [mm]	Min. spacing $s_{min}^{7)}$ [mm]	Min. edge distance $c_{min}^{7)}$ [mm]
							Max. tension load c [mm]	Max. shear load c [mm]			
FAZ II 6	gvz	80	40	8	3,6	3,4	45	55	120	35	45
	A4										
	C										
FAZ II 8	gvz	80	35 ⁵⁾	20	5,0	7,8	85	140	105	40	40
		90	45		6,7		80	125			
	A4	80	35 ⁵⁾		5,0	9,6	85	175	105		
		90	45		6,7		80	160	135		
	C	80	35 ⁵⁾		5,0		85	175	105		
		90	45		6,7		80	160	135		
FAZ II 10	gvz	90	40	45	6,1	12,2	80	205	120	40	45
		110	60		9,5		75	175			
	A4	90	40		15,1	6,1	80	260	120		
		110	60			9,5	75	220	180		
	C	90	40			6,1	80	260	120		
		110	60			9,5	75	220	180		
FAZ II 12	gvz	100	50	60	8,5	17,5	100	275	150	50	55
		120	70		10,5		80	240			
	A4	100	50		21,9	8,5	100	350	150		
		120	70			10,5	80	305	210		
	C	100	50			8,5	100	350	150		
		120	70			10,5	80	305	210		
FAZ II 16	gvz	140	65	110	12,6	31,4	130	410	195	65	65
			85		18,8		170	400			
	A4		65		39,9	12,6	130	535	195		
			85			18,8	170	520	255		
	C		65			12,6	130	535	195		
			85			18,8	170	520	255		
FAZ II 20	gvz	170	100	200	24,0	46,5	530	300	95	95	
	A4					60,7	230				515
	C										
FAZ II 24	gvz	210	125	270	33,6	62,9	630	375	100	135	
	A4					80,7	265				835
	C										

For the design the complete assessment ETA-05/0069, issue date 03.07.2017 has to be considered.⁸⁾

¹⁾ The partial safety factors for material resistance as regulated in the ETA as well as a partial safety factor for load actions of $\gamma_L = 1,4$ are considered. As an single anchor under tension load and shear load without edge influence counts e.g. an anchor with a spacing $s \geq 3 \cdot h_{ef}$ and an edge distance $c \geq 1,5 \cdot h_{ef}$. Concerning shear loads under edge influence and accurate data see ETA.

²⁾ For higher concrete strength classes up to C50/60 higher permissible loads may be possible.

³⁾ Drill method hammer drilling, hollow drilling resp. Diamond drilling.

⁴⁾ Eff. anchorage depth: min. anchorage depth, max. anchorage depth.

⁵⁾ The anchorage depths smaller than 40 mm are only allowed for single anchors as part of a multiple fixing of non-structural systems.

⁶⁾ For combinations of tensile loads, shear loads, bending moments as well as reduced edge distances or spacings (anchor groups) see ETA.

⁷⁾ Minimum possible axial spacings resp. edge distance while reducing the permissible load.

⁸⁾ The given loads refer to the European Technical Assessment ETA-05/0069, issue date 03.07.2017. Design of the loads according TR055/ETAG 001, Annex C, Method A (for static resp. quasi-static loads).

Strong, secure and aesthetic anchoring



VERSIONS

- Zinc-plated steel
- Stainless steel

BUILDING MATERIALS

- Concrete C20/25, cracked and non-cracked

CERTIFICATES

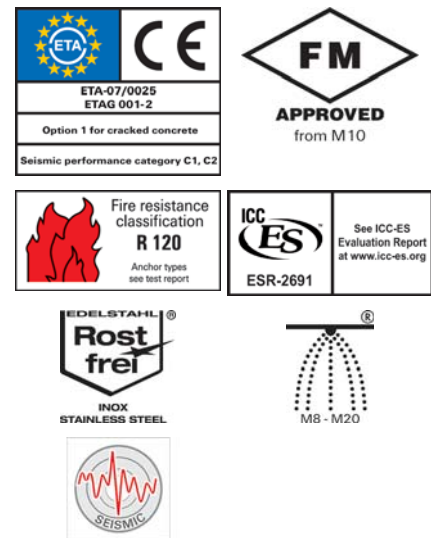

ADVANTAGES

- The international approvals guarantee maximum safety and the best performance. These approvals even cover use in earthquake zones (seismic C1 and C2).
- The anchor is designed with different head styles for fixing points with aesthetic design.
- The design between the bolt and the sleeve ensures high shear load-bearing capacity. Thus, fewer fixing points are required.
- The optimised geometry minimises the energy required for installation and thus allows for fast installation.
- The use of hollow drills is included in the approval.

APPLICATIONS

- Guard rails
- Staircases
- Consoles
- Steel constructions
- Ladders
- Cable trays
- Machines
- Gates
- Façades
- Gratings

FUNCTIONING

- The FH II is suitable for push-through installation.
- When the torque is applied, the cone is pulled into the expansion sleeve which is forced against the drill hole wall.
- The black plastic ring prevents rotation when tightening the anchor and acts as a crumple zone to take the torque slippage, so that the fixture of pulled onto the substrate.
- Alternative head designs for flexible design solutions:
Hexagon head (type S), countersunk head (type SK), bolt version with nut and washer (type B) and cap nut (type H).

INSTALLATION

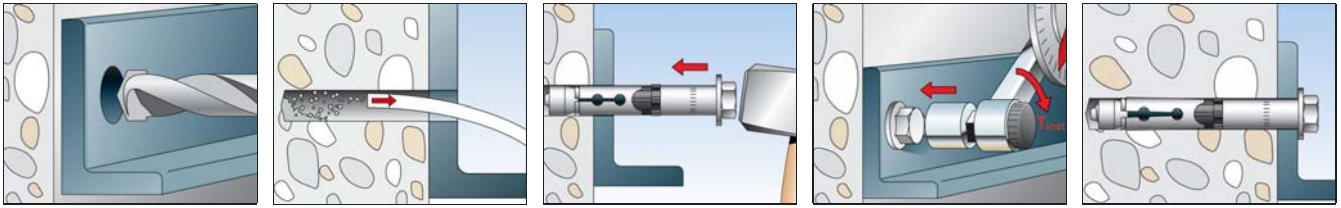

TECHNICAL DATA



High performance anchor **FH II-S**
with hexagonal head

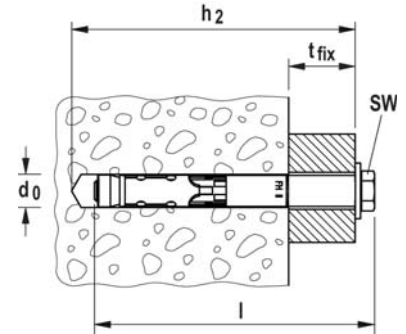

Item	Zinc-plated steel	Stainless steel	Approval		Seismic-Approval	Drill hole diameter d_0 [mm]	Min. drill hole depth for through fixings h_2 [mm]	Anchor length l [mm]	Max. fixture thickness t_{fix} [mm]	Thread M	Width across nut \varnothing SW [mm]	Sales unit [pcs]
	Art.-No.	Art.-No.	ETA	ICC								
	gvz	A4										
FH II 10/10 S	503133	—	■	—	—	10	65	70	10	M 6	10	50
FH II 10/10 S	—	510923	■	—	—	10	65	69	10	M 6	10	50
FH II 10/25 S	503134	—	■	—	—	10	80	85	25	M 6	10	50
FH II 10/25 S	—	510924	■	—	—	10	80	84	25	M 6	10	50
FH II 10/50 S	503135	—	■	—	—	10	105	110	50	M 6	10	50
FH II 12/10 S	044884	—	■	▲	C1 / C2	12	90	90	10	M 8	13	50
FH II 12/10 S	—	510925	■	—	C1 / C2	12	90	90	10	M 8	13	50
FH II 12/25 S	044885	—	■	▲	C1 / C2	12	105	105	25	M 8	13	50
FH II 12/25 S	—	510926	■	—	C1 / C2	12	105	105	25	M 8	13	20
FH II 12/50 S	044886	—	■	▲	C1 / C2	12	130	130	50	M 8	13	25
FH II 15/10 S	044887	—	■	▲	C1 / C2	15	100	106	10	M 10	17	25
FH II 15/10 S	—	510927	■	—	C1 / C2	15	100	107	10	M 10	17	50
FH II 15/25 S	044888	—	■	▲	C1 / C2	15	115	121	25	M 10	17	25
FH II 15/25 S	—	510928	■	—	C1 / C2	15	115	122	25	M 10	17	20
FH II 15/50 S	044889	—	■	▲	C1 / C2	15	140	146	50	M 10	17	25
FH II 18/10 S	046847	—	■	▲	C1 / C2	18	115	118	10	M 12	19	20
FH II 18/25 S	044894	—	■	▲	C1 / C2	18	130	132	25	M 12	19	20
FH II 18/25 S	—	510929	■	—	C1 / C2	18	130	133	25	M 12	19	10
FH II 18/50 S	044896	—	■	▲	C1 / C2	18	155	157	50	M 12	19	20
FH II 24/25 S	044898	—	■	▲	C1 / C2	24	150	160	25	M 16	24	10
FH II 24/25 S	—	502711	■	—	C1 / C2	24	150	160	25	M 16	24	8
FH II 24/50 S	044900	—	■	▲	C1 / C2	24	175	185	50	M 16	24	10
FH II 28/30 S	044901	—	■	▲	C1 / C2	28	185	192	30	M 20	30	4
FH II 28/60 S	044902	—	■	▲	C1 / C2	28	215	222	60	M 20	30	4
FH II 32/30 S	044903	—	■	▲	C1 / C2	32	210	215	30	M 24	36	4
FH II 32/60 S	044904	—	■	▲	C1 / C2	32	240	245	60	M 24	36	4

TECHNICAL DATA



High performance anchor **FH II-SK**
with countersunk head

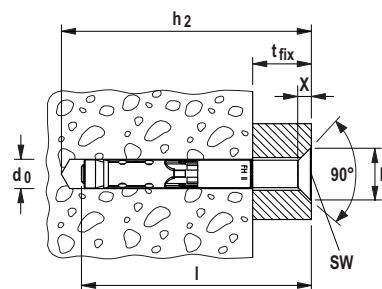

	X [mm]	ØD [mm]
FH II 10/... SK	5,0	19,5
FH II 12/... SK	5,8	22
FH II 15/... SK	5,8	25
FH II 18/... SK	8,0	32

Item	Zinc-plated steel	Stainless steel	Approval		Seismic-Approval	Drill hole diameter d_0 [mm]	Min. drill hole depth for through fixings h_2 [mm]	Anchor length l [mm]	Max. fixture thickness t_{fix} [mm]	Thread M	Width across nut (hexagon socket) ○ SW [mm]	Sales unit [pcs]
	Art.-No.	Art.-No.	ETA	ICC								
	gvz	A4										
FH II 10/15 SK	503136	—	■	—	—	10	70	65	15	M 6	4	50
FH II 10/25 SK	503137	—	■	—	—	10	80	75	25	M 6	4	50
FH II 10/50 SK	503138	—	■	—	—	10	105	100	50	M 6	4	50
FH II 12/15 SK	—	510931	■	—	—	12	95	90	15	M 8	5	25
FH II 12/15 SK	044917	—	■	—	C1 / C2	12	95	90	15	M 8	5	25
FH II 12/25 SK	044918	—	■	—	C1 / C2	12	105	100	25	M 8	5	25
FH II 12/30 SK	—	510932	■	—	C1 / C2	12	110	105	30	M 8	5	25
FH II 12/50 SK	044919	510933	■	—	C1 / C2	12	130	125	50	M 8	5	25
FH II 15/15 SK	044920	510934	■	▲	C1 / C2	15	105	100	15	M 10	6	25
FH II 15/25 SK	044921	—	■	▲	C1 / C2	15	115	110	25	M 10	6	25
FH II 15/50 SK	044922	—	■	▲	C1 / C2	15	140	135	50	M 10	6	25
FH II 18/15 SK	044923	—	■	▲	C1 / C2	18	120	115	15	M 12	8	20
FH II 18/25 SK	044924	—	■	▲	C1 / C2	18	130	125	25	M 12	8	20
FH II 18/30 SK	—	510935	■	—	C1 / C2	18	135	130	30	M 12	8	20
FH II 18/50 SK	044925	—	■	▲	C1 / C2	18	155	150	50	M 12	8	20

TECHNICAL DATA



High performance anchor **FH II-H**
with cap nut

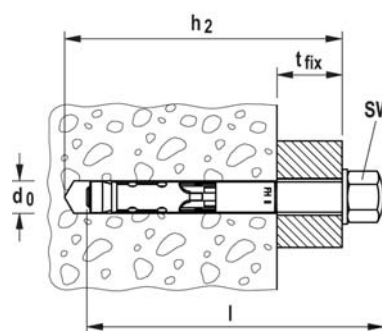

Item	Zinc-plated steel	Approval		Seismic-Approval	Drill hole diameter d_0 [mm]	Min. drill hole depth for through fixings h_2 [mm]	Anchor length l [mm]	Max. fixture thickness t_{fix} [mm]	Thread M	Width across nut ○ SW [mm]	Sales unit [pcs]
	Art.-No.	ETA	ICC								
	gvz										
FH II 10/10 H	503139	■	—	—	10	65	75	10	M 6	13	50
FH II 10/25 H	503140	■	—	—	10	80	90	25	M 6	13	50
FH II 10/50 H	503141	■	—	—	10	105	115	50	M 6	13	50
FH II 12/10 H	044905	■	—	C1 / C2	12	90	100	10	M 8	17	50
FH II 12/25 H	044906	■	—	C1 / C2	12	105	115	25	M 8	17	50
FH II 12/50 H	044907	■	—	C1 / C2	12	130	140	50	M 8	17	25
FH II 15/10 H	044908	■	▲	C1 / C2	15	100	115	10	M 10	17	25

TECHNICAL DATA



High performance anchor **FH II-H** with cap nut

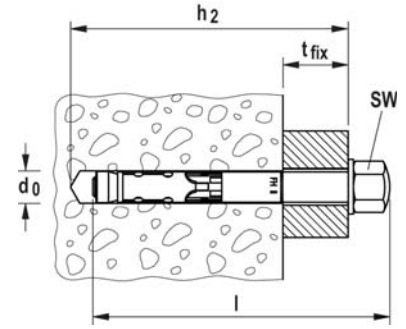

Item	Zinc-plated steel	Approval		Seismic-Approval	Drill hole diameter d_0 [mm]	Min. drill hole depth for through fixings h_2 [mm]	Anchor length l [mm]	Max. fixture thickness t_{fix} [mm]	Thread M	Width across nut \varnothing SW [mm]	Sales unit [pcs]
	Art.-No.	ETA	ICC								
	Art.-No.	ETA	ICC								
	gvz										
FH II 15/25 H	044909	■	▲	C1 / C2	15	115	130	25	M 10	17	25
FH II 15/50 H	044910	■	▲	C1 / C2	15	140	155	50	M 10	17	25
FH II 18/25 H	044915	■	▲	C1 / C2	18	130	145	25	M 12	19	20
FH II 18/50 H	044916	■	▲	C1 / C2	18	155	170	50	M 12	19	20

TECHNICAL DATA



High performance anchor **FH II-B** with hexagon nut and threaded bolt

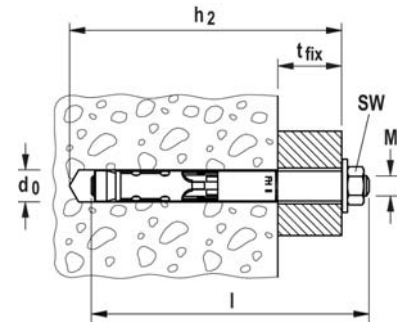

Item	Zinc-plated steel	Approval		Seismic-Approval	Drill hole diameter d_0 [mm]	Min. drill hole depth for through fixings h_2 [mm]	Anchor length l [mm]	Max. fixture thickness t_{fix} [mm]	Thread M	Width across nut \varnothing SW [mm]	Sales unit [pcs]
	Art.-No.	ETA	ICC								
	Art.-No.	ETA	ICC								
	gvz										
FH II 10/10 B	503142	■	—	—	10	65	70	10	M 6	10	50
FH II 10/25 B	503143	■	—	—	10	80	85	25	M 6	10	50
FH II 10/50 B	503144	■	—	—	10	105	110	50	M 6	10	50
FH II 12/10 B	048773	■	▲	C1 / C2	12	90	95	10	M 8	13	50
FH II 12/100 B	046832	■	▲	C1 / C2	12	180	185	100	M 8	13	25
FH II 12/25 B	048774	■	▲	C1 / C2	12	105	110	25	M 8	13	50
FH II 12/50 B	048775	■	▲	C1 / C2	12	130	135	50	M 8	13	25
FH II 15/10 B	048776	■	▲	C1 / C2	15	100	110	10	M 10	17	25
FH II 15/100 B	046835	■	▲	C1 / C2	15	190	200	100	M 10	17	20
FH II 15/25 B	048777	■	▲	C1 / C2	15	115	125	25	M 10	17	25
FH II 15/50 B	048778	■	▲	C1 / C2	15	140	150	50	M 10	17	25
FH II 18/100 B	046841	■	▲	C1 / C2	18	205	215	100	M 12	19	10
FH II 18/25 B	048779	■	▲	C1 / C2	18	130	140	25	M 12	19	20
FH II 18/50 B	048780	■	▲	C1 / C2	18	155	165	50	M 12	19	20
FH II 24/100 B	046842	■	▲	C1 / C2	24	225	242	100	M 16	24	5
FH II 24/25 B	048886	■	▲	C1 / C2	24	150	167	25	M 16	24	10
FH II 24/50 B	048887	■	▲	C1 / C2	24	175	192	50	M 16	24	10
FH II 28/30 B	047547	■	▲	C1 / C2	28	185	199	30	M 20	30	4
FH II 28/60 B	047548	■	▲	C1 / C2	28	215	229	60	M 20	30	4
FH II 32/30 B	047549	■	▲	C1 / C2	32	210	231	30	M 24	36	4
FH II 32/60 B	047550	■	▲	C1 / C2	32	240	261	60	M 24	36	4

LOADS

High performance anchor FH II-S

zinc plated steel / stainless steel A4

Permissible loads of a single anchor in cracked normal concrete (concrete tension zone) of strength class C20/25 (~B25) ^{1) 2) 3) 8)}										Minimum spacings while reducing the load	
Type	Material fixing element	Minimum member thickness	Effective anchorage depth	Installation torque	Permissible tensile load	Permissible shear load	Required edge distance (with one edge) for		Required spacing for	Min. spacing	Min. edge distance
							Max. tension load c	Max. shear load c			
		h _{min} [mm]	h _{ef} [mm]	T _{inst} [Nm]	N _{perm} ⁵⁾ [kN]	V _{perm} ⁵⁾ [kN]	[mm]	[mm]	[mm]	[mm]	[mm]
FH II 10 S	gvz	80	40	10	3,6	4,3	50	105	120	40	40
	A4			15							
FH II 12 S	gvz	120	60	22,5	5,7	15,9	60	320	180	50	50
	A4			25							
FH II 15 S	gvz	140	70	40	7,6	20,1	75	365	210	60	60
	A4										
FH II 18 S	gvz	160	80	80	11,9	24,5	120	410	240	70	70
	A4			100							
FH II 24 S	gvz	200	100	160	17,1	34,3	150	495	300	80	80
	A4										
FH II 28 S ⁴⁾	gvz	250	125	180	24,0	47,9	190	610	375	100	100
FH II 32 S ⁴⁾	gvz	300	150	200	31,5	63,0	225	720	450	120	120

For the design the complete assessment ETA-07/0025 has to be considered.⁷⁾

- The partial safety factors for material resistance as regulated in the ETA-07/0025 as well as a partial safety factor for load actions of $\gamma_L = 1,4$ are considered. As an single anchor counts e.g. an anchor with a spacing $s \geq 3 \cdot h_{ef}$ and an edge distance $c \geq 1,5 \cdot h_{ef}$. Accurate data see ETA-07/0025.
- For higher concrete strength classes up to C50/60 higher permissible loads may be possible.
- Drill method hammer drilling resp. hollow drilling.
- Drill method hollow drilling is not permitted for this size.
- For combinations of tensile loads and shear loads or for shear loads with lever arm (bending moments) as well as reduced edge distances or spacings (anchor groups) we recommend to use our anchor design software C-FIX.
- Minimum possible spacing resp. edge distance while reducing the permissible load for the required minimum member thickness. The combination of minimum edge distance and minimum spacing is not possible. One of both values has to be increased acc. ETA-07/0025.
- The given loads refer to the European Technical Assessment ETA-07/0025, issue date 28.08.2018. Design of the loads according to FprEN 1992-4:2016 and EOTA Technical Report TR 055 (for static resp. quasi-static loads).
- A reinforcement in the concrete to prevent splitting is required. The width of the cracks has to be limited under consideration of the splitting forces at $w_k \sim 0,3\text{mm}$.

LOADS

High performance anchor FH II-SK

zinc plated steel / stainless steel A4

Permissible loads of a single anchor in cracked normal concrete (concrete tension zone) of strength class C20/25 (~B25) ^{1) 2) 3) 8)}										Minimum spacings while reducing the load	
Type	Material fixing element	Minimum member thickness	Effective anchorage depth	Installation torque	Permissible tensile load	Permissible shear load	Required edge distance (with one edge) for		Required spacing for	Min. spacing	Min. edge distance
							Max. tension load c	Max. shear load c			
		h _{min} [mm]	h _{ef} [mm]	T _{inst} [Nm]	N _{perm} ⁵⁾ [kN]	V _{perm} ⁵⁾ [kN]	[mm]	[mm]	[mm]	[mm]	[mm]
FH II 10 SK ⁴⁾	gvz	80	40	10	3,6	4,3	50	105	120	40	40
FH II 12 SK	gvz	120	60	22,5	5,7	15,9	60	320	180	50	50
	A4										
FH II 15 SK	gvz	140	70	40	7,6	20,1	75	365	210	60	60
	A4										
FH II 18 SK	gvz	160	80	80	11,9	24,5	120	410	240	70	70
	A4			100							

For the design the complete assessment ETA-07/0025 has to be considered.⁷⁾

- The partial safety factors for material resistance as regulated in the ETA-07/0025 as well as a partial safety factor for load actions of $\gamma_L = 1,4$ are considered. As an single anchor counts e.g. an anchor with a spacing $s \geq 3 \cdot h_{ef}$ and an edge distance $c \geq 1,5 \cdot h_{ef}$. Accurate data see ETA-07/0025.
- For higher concrete strength classes up to C50/60 higher permissible loads may be possible.
- Drill method hammer drilling resp. hollow drilling.
- Drill method hollow drilling is not permitted for this size.
- For combinations of tensile loads and shear loads or for shear loads with lever arm (bending moments) as well as reduced edge distances or spacings (anchor groups) we recommend to use our anchor design software C-FIX.
- Minimum possible spacing resp. edge distance while reducing the permissible load for the required minimum member thickness. The combination of minimum edge distance and minimum spacing is not possible. One of both values has to be increased acc. ETA-07/0025.
- The given loads refer to the European Technical Assessment ETA-07/0025, issue date 28.08.2018. Design of the loads according to FprEN 1992-4:2016 and EOTA Technical Report TR 055 (for static resp. quasi-static loads).
- A reinforcement in the concrete to prevent splitting is required. The width of the cracks has to be limited under consideration of the splitting forces at $w_k \sim 0,3\text{mm}$.

LOADS

High performance anchor FH II-H

zinc plated steel

Permissible loads of a single anchor in cracked normal concrete (concrete tension zone) of strength class C20/25 (~B25) ^{1) 2) 3) 7)}										Minimum spacings while reducing the load	
Type	Material fixing element	Minimum member thickness	Effective anchorage depth	Installation torque	Permissible tensile load	Permissible shear load	Required edge distance (with one edge) for		Required spacing for	Min. spacing	Min. edge distance
							Max. tension load c	Max. shear load c			
		h_{min} [mm]	h_{ef} [mm]	T_{inst} [Nm]	$N_{perm}^{4)}$ [kN]	$V_{perm}^{4)}$ [kN]	c [mm]	c [mm]	s_{scr} [mm]	$s_{min}^{5)}$ [mm]	$c_{min}^{5)}$ [mm]
FH II 10 H	gvz	80	40	10	3,6	4,3	50	105	120	40	40
FH II 12 H	gvz	120	60	22,5	5,7	15,5	60	315	180	50	50
FH II 15 H	gvz	140	70	40	7,6	20,1	75	365	210	60	60
FH II 18 H	gvz	160	80	80	11,9	24,5	120	410	240	70	70

For the design the complete assessment ETA-07/0025 has to be considered.⁶⁾

¹⁾ The partial safety factors for material resistance as regulated in the ETA-07/0025 as well as a partial safety factor for load actions of $\gamma_L = 1,4$ are considered. As a single anchor counts e.g. an anchor with a spacing $s \geq 3 \cdot h_{ef}$ and an edge distance $c \geq 1,5 \cdot h_{ef}$. Accurate data see ETA-07/0025.

²⁾ For higher concrete strength classes up to C50/60 higher permissible loads may be possible.

³⁾ Drill method hammer drilling resp. hollow drilling.

⁴⁾ For combinations of tensile loads and shear loads or for shear loads with lever arm (bending moments) as well as reduced edge distances or spacings (anchor groups) we recommend to use our anchor design software C-FIX.

⁵⁾ Minimum possible spacing resp. edge distance while reducing the permissible load for the required minimum member thickness. The combination of minimum edge distance and minimum spacing is not possible. One of both values has to be increased acc. ETA-07/0025.

⁶⁾ The given loads refer to the European Technical Assessment ETA-07/0025, issue date 28.08.2018. Design of the loads according to FprEN 1992-4:2016 and EOTA Technical Report TR 055 (for static resp. quasi-static loads).

⁷⁾ A reinforcement in the concrete to prevent splitting is required. The width of the cracks has to be limited under consideration of the splitting forces at $w_k \sim 0,3\text{mm}$.

LOADS

High performance anchor FH II-B

zinc plated steel

Permissible loads of a single anchor in cracked normal concrete (concrete tension zone) of strength class C20/25 (~B25) ^{1) 2) 3) 8)}										Minimum spacings while reducing the load	
Type	Material fixing element	Minimum member thickness	Effective anchorage depth	Installation torque	Permissible tensile load	Permissible shear load	Required edge distance (with one edge) for		Required spacing for	Min. spacing	Min. edge distance
							Max. tension load c	Max. shear load c			
		h_{min} [mm]	h_{ef} [mm]	T_{inst} [Nm]	$N_{perm}^{5)}$ [kN]	$V_{perm}^{5)}$ [kN]	c [mm]	c [mm]	s_{scr} [mm]	$s_{min}^{6)}$ [mm]	$c_{min}^{6)}$ [mm]
FH II 10 B	gvz	80	40	10	3,6	4,3	50	105	120	40	40
FH II 12 B	gvz	120	60	17,5	5,7	15,5	60	315	180	50	50
FH II 15 B	gvz	140	70	38	7,6	20,1	75	365	210	60	60
FH II 18 B	gvz	160	80	80	11,9	24,5	120	410	240	70	70
FH II 24 B	gvz	200	100	120	17,1	34,3	150	495	300	80	80
FH II 28 B⁴⁾	gvz	250	125	180	24,0	47,9	190	610	375	100	100
FH II 32 B⁴⁾	gvz	300	150	200	31,5	63,0	225	720	450	120	120

For the design the complete assessment ETA-07/0025 has to be considered.⁷⁾

¹⁾ The partial safety factors for material resistance as regulated in the ETA-07/0025 as well as a partial safety factor for load actions of $\gamma_L = 1,4$ are considered. As a single anchor counts e.g. an anchor with a spacing $s \geq 3 \cdot h_{ef}$ and an edge distance $c \geq 1,5 \cdot h_{ef}$. Accurate data see ETA-07/0025.

²⁾ For higher concrete strength classes up to C50/60 higher permissible loads may be possible.

³⁾ Drill method hammer drilling resp. hollow drilling.

⁴⁾ Drill method hollow drilling is not permitted for this size.

⁵⁾ For combinations of tensile loads and shear loads or for shear loads with lever arm (bending moments) as well as reduced edge distances or spacings (anchor groups) we recommend to use our anchor design software C-FIX.

⁶⁾ Minimum possible spacing resp. edge distance while reducing the permissible load for the required minimum member thickness. The combination of minimum edge distance and minimum spacing is not possible. One of both values has to be increased acc. ETA-07/0025.

⁷⁾ The given loads refer to the European Technical Assessment ETA-07/0025, issue date 28.08.2018. Design of the loads according to FprEN 1992-4:2016 and EOTA Technical Report TR 055 (for static resp. quasi-static loads).

⁸⁾ A reinforcement in the concrete to prevent splitting is required. The width of the cracks has to be limited under consideration of the splitting forces at $w_k \sim 0,3\text{mm}$.

LOADS

High performance anchor FH II-S

zinc plated steel / stainless steel A4

Permissible loads of a single anchor in non-cracked normal concrete (concrete compression zone) of strength class C20/25 (~B25) ¹⁾²⁾³⁾										Minimum spacings while reducing the load	
Type	Material fixing element	Minimum member thickness	Effective anchorage depth	Installation torque	Permissible tensile load	Permissible shear load	Required edge distance (with one edge) for		Required spacing for	Min. spacing	Min. edge distance
							Max. tension load c	Max. shear load c			
		h _{min} [mm]	h _{ef} [mm]	T _{inst} [Nm]	N _{perm} ⁵⁾ [kN]	V _{perm} ⁵⁾ [kN]	[mm]	[mm]	[mm]	[mm]	[mm]
FH II 10 S	gvz	80	40	10	6,1	6,1	95	100	120	40	40
	A4			15							
FH II 12 S	gvz	120	60	22,5	11,2	18,9	150	265	180	60	60
	A4			25							
FH II 15 S	gvz	140	70	40	14,1	28,2	160	365	210	70	70
	A4										
FH II 18 S	gvz	160	80	80	17,2	34,4	170	405	240	80	80
	A4			100							
FH II 24 S	gvz	200	100	160	24,0	48,1	190	495	300	100	100
	A4										
FH II 28 S ⁴⁾	gvz	250	125	180	33,6	67,2	240	605	375	120	120
FH II 32 S ⁴⁾	gvz	300	150	200	44,2	88,4	285	715	450	160	180

For the design the complete assessment ETA-07/0025 has to be considered.⁷⁾

- ¹⁾ The partial safety factors for material resistance as regulated in the ETA-07/0025 as well as a partial safety factor for load actions of $\gamma_L = 1,4$ are considered. As a single anchor counts e.g. an anchor with a spacing $s \geq 3 \cdot h_{ef}$ and an edge distance $c \geq 1,5 \cdot h_{ef}$. Accurate data see ETA-07/0025.
- ²⁾ For higher concrete strength classes up to C50/60 higher permissible loads may be possible.
- ³⁾ Drill method hammer drilling resp. hollow drilling.
- ⁴⁾ Drill method hollow drilling is not permitted for this size.
- ⁵⁾ For combinations of tensile loads and shear loads or for shear loads with lever arm (bending moments) as well as reduced edge distances or spacings (anchor groups) we recommend to use our anchor design software C-FIX.
- ⁶⁾ Minimum possible spacing resp. edge distance while reducing the permissible load for the required minimum member thickness. The combination of minimum edge distance and minimum spacing is not possible. One of both values has to be increased acc. ETA-07/0025.
- ⁷⁾ The given loads refer to the European Technical Assessment ETA-07/0025, issue date 28.08.2018. Design of the loads according to FprEN 1992-4:2016 and EOTA Technical Report TR 055 (for static resp. quasi-static loads).

LOADS

High performance anchor FH II-SK

zinc plated steel / stainless steel A4

Permissible loads of a single anchor in non-cracked normal concrete (concrete compression zone) of strength class C20/25 (~B25) ¹⁾²⁾³⁾										Minimum spacings while reducing the load	
Type	Material fixing element	Minimum member thickness	Effective anchorage depth	Installation torque	Permissible tensile load	Permissible shear load	Required edge distance (with one edge) for		Required spacing for	Min. spacing	Min. edge distance
							Max. tension load c	Max. shear load c			
		h _{min} [mm]	h _{ef} [mm]	T _{inst} [Nm]	N _{perm} ⁵⁾ [kN]	V _{perm} ⁵⁾ [kN]	[mm]	[mm]	[mm]	[mm]	[mm]
FH II 10 SK ⁴⁾	gvz	80	40	10	6,1	6,1	95	100	120	40	40
FH II 12 SK	gvz	120	60	22,5	11,2	18,9	150	265	180	60	60
	A4										
FH II 15 SK	gvz	140	70	40	14,1	28,2	160	365	210	70	70
	A4										
FH II 18 SK	gvz	160	80	80	17,2	34,4	170	405	240	80	80
	A4			100							

For the design the complete assessment ETA-07/0025 has to be considered.⁷⁾

- ¹⁾ The partial safety factors for material resistance as regulated in the ETA-07/0025 as well as a partial safety factor for load actions of $\gamma_L = 1,4$ are considered. As a single anchor counts e.g. an anchor with a spacing $s \geq 3 \cdot h_{ef}$ and an edge distance $c \geq 1,5 \cdot h_{ef}$. Accurate data see ETA-07/0025.
- ²⁾ For higher concrete strength classes up to C50/60 higher permissible loads may be possible.
- ³⁾ Drill method hammer drilling resp. hollow drilling.
- ⁴⁾ Drill method hollow drilling is not permitted for this size.
- ⁵⁾ For combinations of tensile loads and shear loads or for shear loads with lever arm (bending moments) as well as reduced edge distances or spacings (anchor groups) we recommend to use our anchor design software C-FIX.
- ⁶⁾ Minimum possible spacing resp. edge distance while reducing the permissible load for the required minimum member thickness. The combination of minimum edge distance and minimum spacing is not possible. One of both values has to be increased acc. ETA-07/0025.
- ⁷⁾ The given loads refer to the European Technical Assessment ETA-07/0025, issue date 28.08.2018. Design of the loads according to FprEN 1992-4:2016 and EOTA Technical Report TR 055 (for static resp. quasi-static loads).

LOADS

High performance anchor FH II-H

zinc plated steel

Permissible loads of a single anchor in non-cracked normal concrete (concrete compression zone) of strength class C20/25 (~B25) ^{1) 2) 3)}										Minimum spacings while reducing the load	
Type	Material fixing element	Minimum member thickness	Effective anchorage depth	Installation torque	Permissible tensile load	Permissible shear load	Required edge distance (with one edge) for		Required spacing for	Min. spacing	Min. edge distance
							Max. tension load c	Max. shear load c			
		h_{min} [mm]	h_{ef} [mm]	T_{inst} [Nm]	$N_{perm}^{4)}$ [kN]	$V_{perm}^{4)}$ [kN]	c [mm]	c [mm]	s_{cr} [mm]	$s_{min}^{5)}$ [mm]	$c_{min}^{5)}$ [mm]
FH II 10 H	gvz	80	40	10	6,1	6,1	95	100	120	40	40
FH II 12 H	gvz	120	60	22,5	11,2	15,5	150	215	180	60	60
FH II 15 H	gvz	140	70	40	14,1	24,5	160	310	210	70	70
FH II 18 H	gvz	160	80	80	17,2	34,4	170	405	240	80	80

For the design the complete assessment ETA-07/0025 has to be considered.⁶⁾

¹⁾ The partial safety factors for material resistance as regulated in the ETA-07/0025 as well as a partial safety factor for load actions of $\gamma_L = 1,4$ are considered. As an single anchor counts e.g. an anchor with a spacing $s \geq 3 \cdot h_{ef}$ and an edge distance $c \geq 1,5 \cdot h_{ef}$. Accurate data see ETA-07/0025.

²⁾ For higher concrete strength classes up to C50/60 higher permissible loads may be possible.

³⁾ Drill method hammer drilling resp. hollow drilling.

⁴⁾ For combinations of tensile loads and shear loads or for shear loads with lever arm (bending moments) as well as reduced edge distances or spacings (anchor groups) we recommend to use our anchor design software C-FIX.

⁵⁾ Minimum possible spacing resp. edge distance while reducing the permissible load for the required minimum member thickness. The combination of minimum edge distance and minimum spacing is not possible. One of both values has to be increased acc. ETA-07/0025.

⁶⁾ The given loads refer to the European Technical Assessment ETA-07/0025, issue date 28.08.2018. Design of the loads according to FprEN 1992-4:2016 and EOTA Technical Report TR 055 (for static resp. quasi-static loads).

LOADS

High performance anchor FH II-B

zinc plated steel

Permissible loads of a single anchor in non-cracked normal concrete (concrete compression zone) of strength class C20/25 (~B25) ^{1) 2) 3)}										Minimum spacings while reducing the load	
Type	Material fixing element	Minimum member thickness	Effective anchorage depth	Installation torque	Permissible tensile load	Permissible shear load	Required edge distance (with one edge) for		Required spacing for	Min. spacing	Min. edge distance
							Max. tension load c	Max. shear load c			
		h_{min} [mm]	h_{ef} [mm]	T_{inst} [Nm]	$N_{perm}^{5)}$ [kN]	$V_{perm}^{5)}$ [kN]	c [mm]	c [mm]	s_{cr} [mm]	$s_{min}^{6)}$ [mm]	$c_{min}^{6)}$ [mm]
FH II 10 B	gvz	80	40	10	6,1	6,1	95	100	120	40	40
FH II 12 B	gvz	120	60	17,5	11,2	15,5	150	215	180	60	60
FH II 15 B	gvz	140	70	38	14,1	24,5	160	310	210	70	70
FH II 18 B	gvz	160	80	80	17,2	34,4	170	405	240	80	80
FH II 24 B	gvz	200	100	120	24,0	48,1	190	495	300	100	100
FH II 28 B⁴⁾	gvz	250	125	180	33,6	67,2	240	605	375	120	120
FH II 32 B⁴⁾	gvz	300	150	200	44,2	88,4	285	715	450	160	180

For the design the complete assessment ETA-07/0025 has to be considered.⁷⁾

¹⁾ The partial safety factors for material resistance as regulated in the ETA-07/0025 as well as a partial safety factor for load actions of $\gamma_L = 1,4$ are considered. As an single anchor counts e.g. an anchor with a spacing $s \geq 3 \cdot h_{ef}$ and an edge distance $c \geq 1,5 \cdot h_{ef}$. Accurate data see ETA-07/0025.

²⁾ For higher concrete strength classes up to C50/60 higher permissible loads may be possible.

³⁾ Drill method hammer drilling resp. hollow drilling.

⁴⁾ Drill method hollow drilling is not permitted for this size.

⁵⁾ For combinations of tensile loads and shear loads or for shear loads with lever arm (bending moments) as well as reduced edge distances or spacings (anchor groups) we recommend to use our anchor design software C-FIX.

⁶⁾ Minimum possible spacing resp. edge distance while reducing the permissible load for the required minimum member thickness. The combination of minimum edge distance and minimum spacing is not possible. One of both values has to be increased acc. ETA-07/0025.

⁷⁾ The given loads refer to the European Technical Assessment ETA-07/0025, issue date 28.08.2018. Design of the loads according to FprEN 1992-4:2016 and EOTA Technical Report TR 055 (for static resp. quasi-static loads).

Strong, secure and aesthetic with internal thread for the removal option of the attachment



Stadium seating



Air conditioning units

VERSIONS

- Zinc-plated steel
- Stainless steel

BUILDING MATERIALS

Approved for:

- Concrete C20/25 to C50/60, cracked and non-cracked

Also suitable for:

- Concrete C12/15
- Natural stone with dense structure

CERTIFICATES



ADVANTAGES

- The international approvals guarantee maximum safety and the best performance. The European Technical Assessment even cover use in earthquake zones (seismic C1 and C2).
- The internal threaded anchor allows the removal of the attachment and the fixing point can be reused.
- The design between the bolt and the sleeve ensures high shear load-bearing capacity. Thus, fewer fixing points are required.
- The optimised geometry intelligently reduces the energy required for assembly.
- The approval regulates the use of hollow drills.

APPLICATIONS

- Steel constructions
- Guard rails
- Consoles
- Ladders
- Cable trays
- Machines
- Staircases
- Pipeline routes
- Ventilation systems
- Sprinkler systems

FUNCTIONING

- The FH II-I is suitable for pre-positioned installation.
- When a hexagon wrench is used for installation, the internal thread bolt starts to rotate. This pulls the cone into the expansion sleeve and expands it against the drill-hole wall. At the same time, the anchor is tightened through compression of the black plastic ring. A gap U to the concrete surface is created (see image 4).
- The anchor is set according to the approval when the gap U is 3-5 mm. Alternatively, an installation torque of T_{inst} can also be applied.

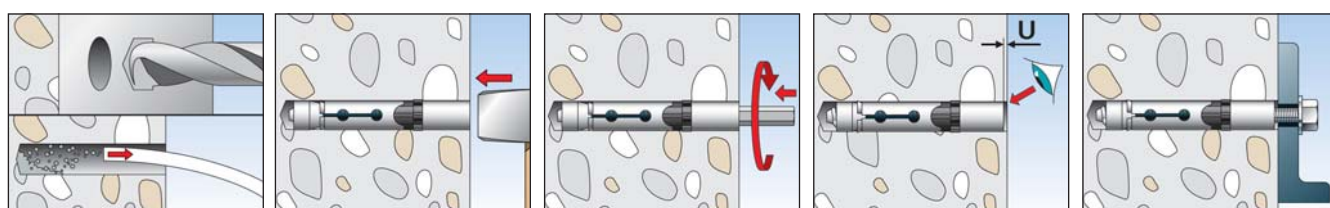

TECHNICAL DATA



High performance anchor **FH II-I**

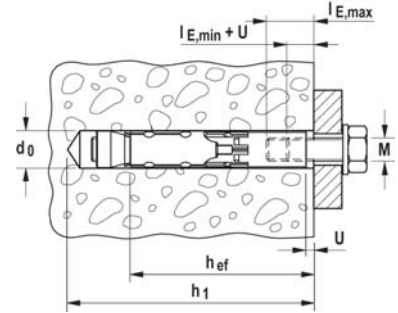

	Zinc plated, steel grade 8.8	Stainless steel	Approval	Drill hole diameter d_0 [mm]	Min. drill hole depth for pre-positioned installation h_1 [mm]	Anchor length l [mm]	Thread M	Min. bolt penetration $l_{E,min}$ [mm]	Max. bolt penetration $l_{E,max}$ [mm]	Sales unit [pcs]
Item	Art.-No.	Art.-No.	ETA							
	gvz	A4								
FH II 12/M6 I	520358	520360	■	12	85	77.5	M 6	11 + U	25	25
FH II 12/M8 I	520359	520361	■	12	85	77.5	M 8	13 + U	25	25
FH II 15/M10 I	519014	519018	■	15	95	90	M 10	10 + U	25	25
FH II 15/M12 I	519015	519019	■	15	95	90	M 12	12 + U	25	20

ACCESSORIES



Setting tool **FH II-I**

Item	Art.-No.	Matching anchor type	Sales unit [pcs]
Setting tool FH II-I M6-M10	532780	FH II 12/M6 I, FH II 15/M 10 I	10
Setting tool FH II-I M8-M12	532781	FH II 12/M8 I, FH II 15/M 12 I	10

LOADS

High performance anchor with internal thread **FH II-I**
zinc plated steel / stainless steel

Permissible loads of a single anchor in cracked normal concrete (concrete tension zone) of strength class C20/25 (~B25) ^{1) 2) 3) 6)}										Minimum spacings while reducing the load	
Type	Screw material resp. screw surface	Minimum member thickness h_{min} [mm]	Effective anchorage depth h_{ef} [mm]	Installation torque T_{inst} [Nm]	Permissible tensile load $N_{perm}^{4)}$ [kN]	Permissible shear load $V_{perm}^{4)}$ [kN]	Required edge distance (with one edge) for		Required spacing for s [mm]	Min. spacing s_{min} [mm]	Min. edge distance c_{min} [mm]
							Max. tension load c [mm]	Max. shear load c [mm]			
FH II 12/M 6 I	5.8	130	60	15	4,3	2,9	55	55	180	50	50
	8.8							80			
	A4-70							60			
FH II 12/M 8 I	5.8	130	60	15	4,3	5,1	55	90	180	50	50
	8.8							145			
	A4-70							105			
FH II 15/M 10 I	5.8	150	70	25	5,7	8,6	65	135	210	60	60
	8.8							220			
	A4-70							145			
FH II 15/M 12 I	5.8	150	70	25	5,7	12,0	65	200	210	60	60
	8.8							230			
	A4-70							230			

For the design the complete assessment ETA-07/0025 has to be considered.⁵⁾

¹⁾ The partial safety factors for material resistance as regulated in the ETA-07/0025 as well as a partial safety factor for load actions of $\gamma_F = 1,4$ are considered. As an single anchor counts e.g. an anchor with a spacing $s \geq 3 \cdot h_{ef}$ and an edge distance $c \geq 1,5 \cdot h_{ef}$. Accurate data see ETA-07/0025.

²⁾ For higher concrete strength classes up to C50/60 higher permissible loads may be possible.

³⁾ Drill method Hammer drilling resp. hollow drilling.

⁴⁾ For combinations of tensile loads, shear loads, bending moments as well as reduced edge distances or spacings (anchor groups) see ETA-07/0025.

⁵⁾ The given loads refer to the European Technical Assessment ETA-07/0025, issue date 09/12/2016. Design of the loads according ETAG 001, Annex C, Method A (for static resp. quasi-static loads).

⁶⁾ A reinforcement in the concrete to prevent splitting is required. The width of the cracks has to be limited under consideration of the splitting forces at $w_k \sim 0,3mm$ begrenzt.

LOADS

High performance anchor with internal thread FH II-I

zinc plated steel / stainless steel

Permissible loads of a single anchor in non-cracked normal concrete (concrete compression zone) of strength class C20/25 (~B25) ¹⁾²⁾³⁾										Minimum spacings while reducing the load	
Type	Screw material resp. screw surface	Minimum member thickness h_{min} [mm]	Effective anchorage depth h_{ef} [mm]	Installation torque T_{inst} [Nm]	Permissible tensile load $N_{perm}^{4)}$ [kN]	Permissible shear load $V_{perm}^{4)}$ [kN]	Required edge distance (with one edge) for		Required spacing for Max. Load s [mm]	Min. spacing s_{min} [mm]	Min. edge distance c_{min} [mm]
							Max. tension load c [mm]	Max. shear load c [mm]			
FH II 12/M 6 I	5.8	130	60	15	4,8	2,9	60	60	180	60	60
	8.8				7,6	4,6	85				
	A4-70				5,3	3,2	60				
FH II 12/M 8 I	5.8	130	60	15	9,0	5,1	115	65	180	60	60
	8.8				8,0	125	100				
	A4-70				6,0	75	75				
FH II 15/M 10 I	5.8	150	70	25	13,8	8,6	160	95	210	70	70
	8.8				13,1	150					
	A4-70				9,2	100					
FH II 15/M 12 I	5.8	150	70	25	14,1	12,0	160	135	210	70	70
	8.8					13,7		155			
	A4-70										

For the design the complete assessment ETA-07/0025 has to be considered.⁵⁾

¹⁾ The partial safety factors for material resistance as regulated in the ETA-07/0025 as well as a partial safety factor for load actions of $\gamma_F = 1,4$ are considered. As a single anchor counts e.g. an anchor with a spacing $s \geq 3 \cdot h_{ef}$ and an edge distance $c \geq 1,5 \cdot h_{ef}$. Accurate data see ETA-07/0025..

²⁾ For higher concrete strength classes up to C50/60 higher permissible loads may be possible.

³⁾ Drill method Hammer drilling resp. hollow drilling.

⁴⁾ For combinations of tensile loads, shear loads, bending moments as well as reduced edge distances or spacings (anchor groups) see ETA-07/0025.

⁵⁾ The given loads refer to the European Technical Assessment ETA-07/0025, issue date 09/12/2016. Design of the loads according ETAG 001, Annex C, Method A (for static resp. quasi-static loads).

The fixing system with the highest safety in cracked concrete

High performance steel anchors 4



Steel girders



Installations in tunnels

VERSIONS

- Zinc-plated steel
- Stainless steel

BUILDING MATERIALS

Approved for:

- Concrete C20/25 to C50/60, cracked and non-cracked

Also suitable for:

- Concrete C12/15
- Natural stone with dense structure

CERTIFICATES

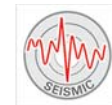
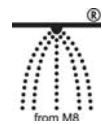

ADVANTAGES

- The special ZYKON undercut technology allows for a positive fit connection and ensures maximum safety, even in large cracks.
- The almost expansion-free installation of the anchor allows small edge distances and axial spacing, and thereby enables flexible use.
- The FZUB special drill allows for a fast installation by creating the undercut without having to change tools.
- The drill hole geometry allows for a very low setting energy, thus reducing the energy required for installation.
- The ideal interaction of threaded bolts and sleeve with FZA-D allows for a high shear load and therefore fewer fixing points.

APPLICATIONS

- Steelwork constructions
- Guard rails
- Consoles
- Step irons (FZA-ST)
- Ladders
- Cable trays
- Machines
- Staircases
- Gates
- Façades

FUNCTIONING

- The FZA and FZA-I is suitable for pre-positioned installation, whereas the FZA-D is suitable for push-through installation.
- The undercut drill hole is created using the special FZUB drill.
- Once the anchor has been placed in the drill hole, the expansion sleeve is driven over the cone using the FZE Plus setting tool, and the undercut drill hole is filled with a positive fit.

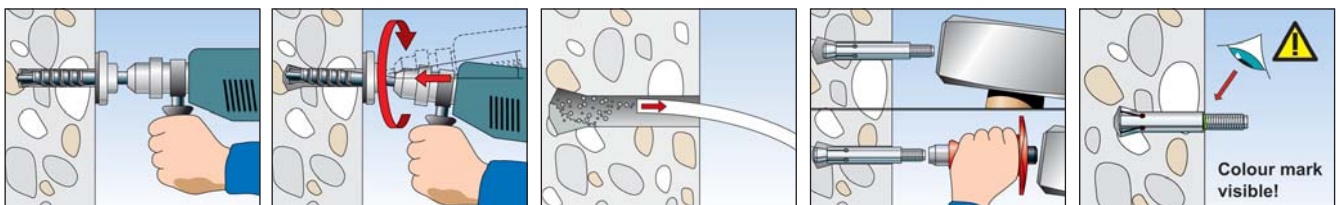

Colour mark visible!

TECHNICAL DATA



ZYKON Bolt anchor **FZA**

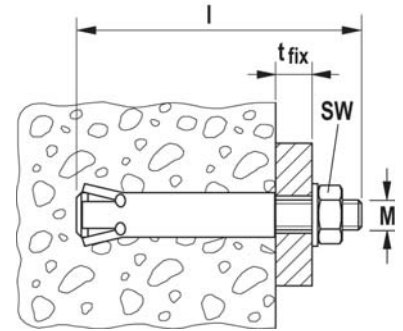

Item	Zinc-plated steel	Stainless steel	Approval ETA	Seismic-Approval	Required drill bit FZUB	Required setting tool FZE plus	Bolt length	Max. fixture thickness	Thread	Width across nut	Sales unit
	Art.-No.	Art.-No.					l [mm]	t _{fix} [mm]	M	○ SW [mm]	[pcs]
	Art.-No.	Art.-No.									
	gvz	A4									
FZA 10 x 40 M6/10	060712	060772	■	–	10 x 40	FZE 10 plus	60	10	M 6	10	25
FZA 12 x 40 M 8/15	060715	060775	■	–	12 x 40	FZE 12 plus	69	15	M 8	13	25
FZA 12 x 50 M 8/15	060716	060776	■	–	12 x 50	FZE 12 plus	79	15	M 8	13	20
FZA 12 x 50 M 8/50	–	060774	■	–	12 x 50	FZE 12 plus	114	50	M 8	13	20
FZA 14 x 40 M10/25	060718	–	■	C1	14 x 40	FZE 14 plus	79	25	M 10	17	25
FZA 14 x 40 M10/25	–	060778	■	C1	14 x 40	FZE 14 plus	79	25	M 10	17	20
FZA 14 x 60 M10/25	060719	060779	■	C1	14 x 60	FZE 14 plus	102	25	M 10	17	10
FZA 14 x 60 M10/50	–	060766	■	C1	14 x 60	FZE 14 plus	126	50	M 10	17	10
FZA 18 x 80 M12/25	060721	060781	■	C1	18 x 80	FZE 18 plus	126	25	M 12	19	10
FZA 18 x 80 M12/55	–	060767	■	C1	18 x 80	FZE 18 plus	156	55	M 12	19	10
FZA 22 x 100 M16/60	060724	060782	■	C1	22 x 100	FZE 22 plus	184	60	M 16	24	10
FZA 22 x 125 M16/60	060725	060768	■	C1	22 x 125	FZE 22 plus	209	60	M 16	24	6

TECHNICAL DATA



ZYKON Through anchor **FZA-D**

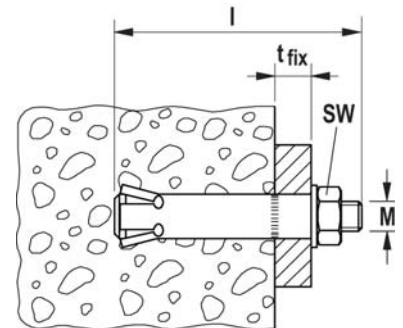

Item	Zinc-plated steel	Stainless steel	Approval ETA	Seismic-Approval	Required drill bit FZUB	Required setting tool FZE plus	Bolt length	Max. fixture thickness	Thread	Width across nut	Sales unit
	Art.-No.	Art.-No.					l [mm]	t _{fix} [mm]	M	○ SW [mm]	[pcs]
	Art.-No.	Art.-No.									
	gvz	A4									
FZA 12 x 50 M 8 D/10	060652	060664	■	–	12 x 50	FZE 12 plus	69	10	M 8	13	25
FZA 12 x 60 M 8 D/10	060653	060665	■	–	12 x 60	FZE 12 plus	79	10	M 8	13	25
FZA 12 x 80 M 8 D/30	060654	060666	■	–	12 x 80	FZE 12 plus	99	30	M 8	13	25
FZA 14 x 80 M10 D/20	060657	060669	■	C1	14 x 80	FZE 14 plus	102	20	M 10	17	10
FZA 14 x 100 M 8 D/30	060658	060670	■	C1	14 x 100	FZE 14 plus	126	40	M 10	17	10
FZA 18 x 100 M12 D/20	060684	060672	■	C1	18 x 100	FZE 18 plus	126	20	M 12	19	10
FZA 18 x 130 M12 D/50	060685	060673	■	C1	18 x 130	FZE 18 plus	156	50	M 12	19	10
FZA 22 x 125 M16 D/25	060663	060675	■	C1	22 x 125	FZE 22 plus	156	25	M 16	24	10

TECHNICAL DATA



Zykon anchor for fixing step irons
FZA ST A4

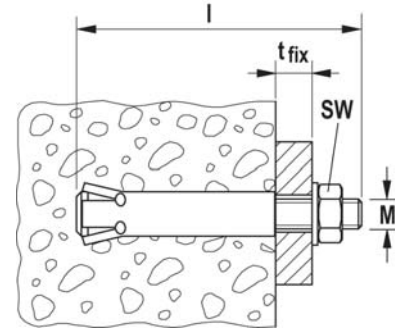

	Stainless steel		Required drill bit FZUB	Required setting tool FZE plus	Max. fixture thickness t_{fix} [mm]	Thread M	Width across nut \varnothing SW [mm]	Sales unit [pcs]	
Item	Art.-No.	A4							
FZA 14 x 40 ST A4	060686 1)		14 x 40	FZE 14 plus	30	M 10	16	20	
FZA 14 x 60 ST A4	060687 1)		14 x 60	FZE 14 plus	30	M 10	16	20	

1) According to DIN 1211GS/1212GS.

TECHNICAL DATA



ZYKON Internally-threaded anchor **FZA-I**

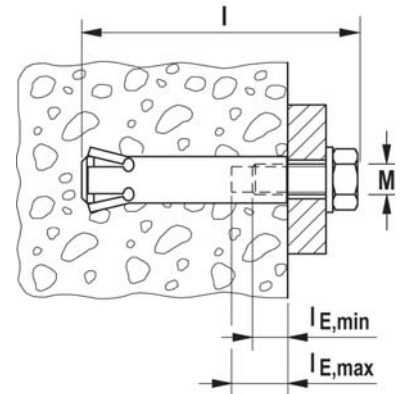

	Zinc-plated steel	Stainless steel	Approval	Required drill bit FZUB	Required setting tool FZE plus	Internal thread	Min. bolt penetration $l_{E,min}$ [mm]	Max. bolt penetration $l_{E,max}$ [mm]	Sales unit [pcs]
Item	Art.-No.	Art.-No.	ETA			A1			
	gvz	A4							
FZA 12 x 40 M6 I	060758	060783	■	12 x 40	FZE 12 plus	M 6	10	15	25
FZA 12 x 50 M6 I	—	060784	■	12 x 50	FZE 12 plus	M 6	10	15	25
FZA 14 x 60 M8 I	060760	060786	■	14 x 60	FZE 14 plus	M 8	11	17	20
FZA 18 x 80 M10 I	060761	060787	■	18 x 80	FZE 18 plus	M 10	13	21	10
FZA 22 x 100 M12 I	060763	060788	■	22 x 100	FZE 22 plus	M 12	15	25	10
FZA 22 x 125 M12 I	060769	060770	■	22 x 125	FZE 22 plus	M 12	15	25	10

ACCESSORIES



Drill bit **FZUB**

Item	Art.-No.	Fits anchor			Sales unit [pcs]
		bolt anchor	push-through anchor	internal thread anchor	
FZUB 10 x 40	060622	FZA 10 x 40 M6	-	-	1
FZUB 12 x 40	060623	FZA 12 x 40 M8	-	FZA 12 x 40 M6 I	1
FZUB 12 x 50	060627	FZA 12 x 50 M8	FZA 12 x 50 M8 D/10	FZA 12 x 50 M6 I	1
FZUB 12 x 60	060625	-	FZA 12 x 60 M8 D/10	-	1
FZUB 12 x 80	060626	-	FZA 12 x 80 M8 D/30	-	1
FZUB 14 x 40	060624	FZA 14 x 40 M10	-	-	1
FZUB 14 x 60	060628	FZA 14 x 60 M10	-	FZA 14 x 60 M8 I	1
FZUB 14 x 80	060629	-	FZA 14 x 80 M10 D/20	-	1
FZUB 14 x 100	060630	-	FZA 14 x 100 M10 D/40	-	1
FZUB 18 x 80	060634	FZA 18 x 80 M12	-	FZA 18 x 80 M10I	1
FZUB 18 x 100	060632	-	FZA 18 x 100 M12 D/20	-	1
FZUB 18 x 130	060633	-	FZA 18 x 130 M12 D/50	-	1
FZUB 22 x 100	060636	FZA 22 x 100 M16	-	FZA 22 x 100 M12 I	1
FZUB 22 x 125	060638	FZA 22 x 125 M16	FZA 22 x 125 M16 D/25	FZA 22 x 125 M12 I	1

ACCESSORIES



Setting tool **FZE plus**

Item	Art.-No.	Fits anchor			Sales unit [pcs]
		bolt anchor	push-through anchor	internal thread anchor	
FZE 10 plus	044637 ¹⁾	FZA 10 x ... M6	-	-	1
FZE 12 plus	044638	FZA 12 x ... M8	FZA 12 x ... M8 D	FZA 12 x ... M6 I	1
FZE 14 plus	044639	FZA 14 x ... M10	FZA 14 x ... M10 D	FZA 14 x ... M8 I	1
FZE 18 plus	044640	FZA 18 x ... M12	FZA 18 x ... M12 D	FZA 18 x ... M10 I	1
FZE 22 plus	044641	FZA 22 x ... M16	FZA 22 x ... M16 D	FZA 22 x ... M12 I	1

1) Without centring pin.

LOADS

ZYKON Bolt anchor FZA

zinc plated steel / stainless steel

Permissible loads of a single anchor in cracked normal concrete (concrete tension zone) of strength class C20/25 (~B25) ^{1) 2) 3) 8)}										Minimum spacings while reducing the load	
Type	Material fixing element	Minimum member thickness	Effective anchorage depth	Installation torque	Permissible tensile load	Permissible shear load	Required edge distance (with one edge) for		Required spacing for	Min. spacing	Min. edge distance
							Max. tension load c	Max. shear load c			
		h_{min} [mm]	h_{ef} [mm]	T_{inst} [Nm]	$N_{perm}^{4)}$ [kN]	$V_{perm}^{4)}$ [kN]	[mm]	[mm]	Max. Load s [mm]	$s_{min}^{5) 6)}$ [mm]	$c_{min}^{5) 6)}$ [mm]
FZA 10 x 40 M6	gvz	100	40	8,5	2,4	4,6	35	95	120	40	35
	A4							65			
FZA 12 x 40 M8	gvz	100	40	20	2,4	5,6	40	120	120	40	40
	A4										
FZA 12 x 50 M8	gvz	110	50	20	4,3	7,9	45	160	150	50	45
	A4							115			
FZA 14 x 40 M10	gvz	100	40	40	2,4	5,6	70	115	120	70	70
	A4										
FZA 14 x 60 M10	gvz	130	60	40	5,7	13,3	60	245	180	60	55
	A4					9,3		165			
FZA 18 x 80 M12	gvz	160	80	60	9,5	19,3	85	315	240	80	70
	A4					13,5		210			
FZA 22 x 100 M16	gvz	200	100	100	17,1	34,3	150	500	300	100	100
	A4					25,2		355			
FZA 22 x 125 M16	gvz	250	125	100	19,0	35,9	140	450	375	125	125
	A4					25,2		300			

For the design the complete assessment ETA-98/0004 has to be considered.⁷⁾

¹⁾ The partial safety factors for material resistance as regulated in the ETA-98/0004 as well as a partial safety factor for load actions of $\gamma_L = 1,4$ are considered. As an single anchor counts e.g. an anchor with a spacing $s \geq 3 \cdot h_{ef}$ and an edge distance $c \geq 1,5 \cdot h_{ef}$. Accurate data see ETA-98/0004.

²⁾ For higher concrete strength classes up to C50/60 higher permissible loads may be possible.

³⁾ Drill method hammer drilling.

⁴⁾ For combinations of tensile loads, shear loads, bending moments as well as reduced edge distances or spacings (anchor groups) see ETA-98/0004.

⁵⁾ Minimum possible axial spacings resp. edge distance while reducing the permissible load.

⁶⁾ Minimum possible spacing resp. edge distance while reducing the permissible load for the required minimum member thickness. The combination of minimum edge distance and minimum spacing is not possible. One of both values has to be increased acc. ETA-98/0004.

⁷⁾ The given loads refer to the European Technical Assessment ETA-98/0004, issue date 12/09/2016. Design of the loads according ETAG 001, Annex C, Method A (for static resp. quasi-static loads).

LOADS

ZYKON-Bolt anchor FZA

zinc plated steel / stainless steel

Permissible loads of a single anchor in non-cracked normal concrete (concrete compression zone) of strength class C20/25 (~B25) ¹⁾²⁾³⁾										Minimum spacings while reducing the load	
Type	Material fixing element	Minimum member thickness h_{min} [mm]	Effective anchorage depth h_{ef} [mm]	Installation torque T_{inst} [Nm]	Permissible tensile load $N_{perm}^{4)}$ [kN]	Permissible shear load $V_{perm}^{4)}$ [kN]	Required edge distance (with one edge) for		Required spacing for Max. Load s [mm]	Min. spacing $s_{min}^{5)6)}$ [mm]	Min. edge distance $c_{min}^{5)6)}$ [mm]
							Max. tension load c [mm]	Max. shear load c [mm]			
FZA 10 x 40 M6	gvz	100	40	8,5	3,6	4,6	40	65	120	40	35
	A4							50			
FZA 12 x 40 M8	gvz	100	40	20	3,6	7,9	40	120	120	40	40
	A4							85			
FZA 12 x 50 M8	gvz	110	50	20	5,7	8,4	45	115	150	50	45
	A4							75			
FZA 14 x 40 M10	gvz	100	40	40	3,6	7,9	70	115	120	70	70
	A4										
FZA 14 x 60 M10	gvz	130	60	40	9,5	13,3	75	170	180	60	55
	A4							110			
FZA 18 x 80 M12	gvz	160	80	60	14,3	19,3	95	210	240	80	70
	A4							140			
FZA 22 x 100 M16	gvz	200	100	100	19,0	35,9	110	355	300	100	100
	A4							235			
FZA 22 x 125 M16	gvz	250	125	100	19,0	35,9	125	300	375	125	125
	A4							195			

For the design the complete assessment ETA-98/0004 has to be considered.⁷⁾

¹⁾ The partial safety factors for material resistance as regulated in the ETA-98/0004 as well as a partial safety factor for load actions of $\gamma_L = 1,4$ are considered. As an single anchor counts e.g. an anchor with a spacing $s \geq 3 \cdot h_{ef}$ and an edge distance $c \geq 1,5 \cdot h_{ef}$. Accurate data see ETA-98/0004.

²⁾ For higher concrete strength classes up to C50/60 higher permissible loads may be possible.

³⁾ Drill method hammer drilling.

⁴⁾ For combinations of tensile loads, shear loads, bending moments as well as reduced edge distances or spacings (anchor groups) see ETA-98/0004.

⁵⁾ Minimum possible axial spacings resp. edge distance while reducing the permissible load.

⁶⁾ Minimum possible spacing resp. edge distance while reducing the permissible load for the required minimum member thickness. The combination of minimum edge distance and minimum spacing is not possible. One of both values has to be increased acc. ETA-98/0004.

⁷⁾ The given loads refer to the European Technical Assessment ETA-98/0004, issue date 12/09/2016. Design of the loads according ETAG 001, Annex C, Method A (for static resp. quasi-static loads).

LOADS

ZYKON Through anchor FZA-D

zinc plated steel / stainless steel

Permissible loads of a single anchor in cracked normal concrete (concrete tension zone) of strength class C20/25 (~B25) ^{1) 2) 3) 8)}										Minimum spacings while reducing the load	
Type	Material fixing element	Minimum member thickness	Effective anchorage depth	Installation torque	Permissible tensile load	Permissible shear load	Required edge distance (with one edge) for		Required spacing for	Min. spacing	Min. edge distance
							Max. tension load c	Max. shear load c			
		h_{min} [mm]	h_{ef} [mm]	T_{inst} [Nm]	$N_{perm}^{4)}$ [kN]	$V_{perm}^{4)}$ [kN]	[mm]	[mm]	Max. Load s [mm]	$s_{min}^{5) 6)}$ [mm]	$c_{min}^{5) 6)}$ [mm]
FZA 12 x 50 M8 D	gvz	100	40	20	2,4	5,6	35	120	120	40	35
	A4										
FZA 12 x 60 M8 D	gvz	110	50	20	4,3	7,9	45	160	150	50	45
	A4										
FZA 14 x 80 M10 D	gvz	130	60	40	5,7	13,3	60	245	180	60	55
	A4										
FZA 18 x 100 M12 D	gvz	160	80	60	9,5	19,3	85	315	240	80	70
	A4										
FZA 22 x 125 M16 D	gvz	200	100	100	17,1	34,3	150	500	300	100	100
	A4										

For the design the complete assessment ETA-98/0004 has to be considered.⁷⁾

¹⁾ The partial safety factors for material resistance as regulated in the ETA-98/0004 as well as a partial safety factor for load actions of $\gamma_L = 1,4$ are considered. As a single anchor counts e.g. an anchor with a spacing $s \geq 3 \cdot h_{ef}$ and an edge distance $c \geq 1,5 \cdot h_{ef}$. Accurate data see ETA-98/0004.

²⁾ For higher concrete strength classes up to C50/60 higher permissible loads may be possible.

³⁾ Drill method hammer drilling.

⁴⁾ For combinations of tensile loads, shear loads, bending moments as well as reduced edge distances or spacings (anchor groups) see ETA-98/0004.

⁵⁾ Minimum possible axial spacings resp. edge distance while reducing the permissible load.

⁶⁾ Minimum possible spacing resp. edge distance while reducing the permissible load for the required minimum member thickness. The combination of minimum edge distance and minimum spacing is not possible. One of both values has to be increased acc. ETA-98/0004.

⁷⁾ The given loads refer to the European Technical Assessment ETA-98/0004, issue date 12/09/2016. Design of the loads according ETAG 001, Annex C, Method A (for static resp. quasi-static loads).

⁸⁾ A reinforcement in the concrete to prevent splitting is required. The width of the cracks has to be limited under consideration of the splitting forces at $w_k \sim 0,3\text{mm}$.

LOADS

ZYKON Through anchor FZA-D

zinc plated steel / stainless steel

Permissible loads of a single anchor in non-cracked normal concrete (concrete compression zone) of strength class C20/25 (~B25) ^{1) 2) 3)}										Minimum spacings while reducing the load	
Type	Material fixing element	Minimum member thickness	Effective anchorage depth	Installation torque	Permissible tensile load	Permissible shear load	Required edge distance (with one edge) for		Required spacing for	Min. spacing	Min. edge distance
							Max. tension load c	Max. shear load c			
		h_{min} [mm]	h_{ef} [mm]	T_{inst} [Nm]	$N_{perm}^{4)}$ [kN]	$V_{perm}^{4)}$ [kN]	[mm]	[mm]	Max. Load s [mm]	$s_{min}^{5) 6)}$ [mm]	$c_{min}^{5) 6)}$ [mm]
FZA 12 x 50 M8 D	gvz	100	40	20	3,6	7,9	40	120	120	40	35
	A4										
FZA 12 x 60 M8 D	gvz	110	50	20	5,7	8,4	45	115	150	50	45
	A4										
FZA 14 x 80 M10 D	gvz	130	60	40	9,5	13,3	75	170	180	60	55
	A4										
FZA 18 x 100 M12 D	gvz	160	80	60	14,3	19,3	95	210	240	80	70
	A4										
FZA 22 x 125 M16 D	gvz	200	100	100	19,0	35,9	110	355	300	100	100
	A4										

For the design the complete assessment ETA-98/0004 has to be considered.⁷⁾

¹⁾ The partial safety factors for material resistance as regulated in the ETA-98/0004 as well as a partial safety factor for load actions of $\gamma_L = 1,4$ are considered. As a single anchor counts e.g. an anchor with a spacing $s \geq 3 \cdot h_{ef}$ and an edge distance $c \geq 1,5 \cdot h_{ef}$. Accurate data see ETA-98/0004.

²⁾ For higher concrete strength classes up to C50/60 higher permissible loads may be possible.

³⁾ Drill method hammer drilling.

⁴⁾ For combinations of tensile loads, shear loads, bending moments as well as reduced edge distances or spacings (anchor groups) see ETA-98/0004.

⁵⁾ Minimum possible axial spacings resp. edge distance while reducing the permissible load.

⁶⁾ Minimum possible spacing resp. edge distance while reducing the permissible load for the required minimum member thickness. The combination of minimum edge distance and minimum spacing is not possible. One of both values has to be increased acc. ETA-98/0004.

⁷⁾ The given loads refer to the European Technical Assessment ETA-98/0004, issue date 12/09/2016. Design of the loads according ETAG 001, Annex C, Method A (for static resp. quasi-static loads).

LOADS

ZYKON-Internally-threaded anchor FZA-I

zinc plated steel / stainless steel

Permissible loads of a single anchor in cracked normal concrete (concrete tension zone) of strength class C20/25 (~B25) ¹⁾²⁾³⁾⁸⁾										Minimum spacings while reducing the load	
Type	Screw material resp. screw surface	Minimum member thickness	Effective anchorage depth	Installation torque	Permissible tensile load	Permissible shear load	Required edge distance (with one edge) for		Required spacing for	Min. spacing	Min. edge distance
							Max. tension load c	Max. shear load c			
		h_{min} [mm]	h_{ef} [mm]	T_{inst} [Nm]	$N_{perm}^{4)}$ [kN]	$V_{perm}^{4)}$ [kN]	[mm]	[mm]	Max. Load s [mm]	$s_{min}^{5)6)}$ [mm]	$c_{min}^{5)6)}$ [mm]
FZA 12 x 40 M6 I	8.8	100	40	8,5	2,4	4,1	35	85	120	40	35
	A4-70										
FZA 12 x 50 M6 I	A4-70	110	50	8,5	4,3	3,2	45	65	150	50	45
FZA 14 x 60 M8 I	8.8	130	60	15	5,7	5,4	60	90	180	60	55
	A4-70										
FZA 18 x 80 M10 I	8.8	160	80	30	9,5	5,6	85	85	240	80	70
	A4-70										
FZA 22 x 100 M12 I	8.8	200	100	60	17,1	13,2	150	165	300	100	100
	A4-70										
FZA 22 x 125 M12 I	8.8	250	125	60	19,0	13,2	140	150	375	125	125
	A4-70										

For the design the complete assessment ETA-98/0004 has to be considered.⁷⁾

¹⁾ The partial safety factors for material resistance as regulated in the ETA-98/0004 as well as a partial safety factor for load actions of $\gamma_L = 1,4$ are considered. As a single anchor counts e.g. an anchor with a spacing $s \geq 3 \cdot h_{ef}$ and an edge distance $c \geq 1,5 \cdot h_{ef}$. Accurate data see ETA-98/0004.

²⁾ For higher concrete strength classes up to C50/60 higher permissible loads may be possible.

³⁾ Drill method hammer drilling.

⁴⁾ For combinations of tensile loads, shear loads, bending moments as well as reduced edge distances or spacings (anchor groups) see ETA-98/0004.

⁵⁾ Minimum possible axial spacings resp. edge distance while reducing the permissible load.

⁶⁾ Minimum possible spacing resp. edge distance while reducing the permissible load for the required minimum member thickness. The combination of minimum edge distance and minimum spacing is not possible. One of both values has to be increased acc. ETA-98/0004.

⁷⁾ The given loads refer to the European Technical Assessment ETA-98/0004, issue date 12/09/2016. Design of the loads according ETAG 001, Annex C, Method A (for static resp. quasi-static loads).

⁸⁾ A reinforcement in the concrete to prevent splitting is required. The width of the cracks has to be limited under consideration of the splitting forces at $w_k \sim 0,3\text{mm}$.

LOADS

ZYKON-Internally-threaded anchor FZA-I

zinc plated steel / stainless steel

Permissible loads of a single anchor in non-cracked normal concrete (concrete compression zone) of strength class C20/25 (~B25) ¹⁾²⁾³⁾										Minimum spacings while reducing the load	
Type	Screw material resp. screw surface	Minimum member thickness	Effective anchorage depth	Installation torque	Permissible tensile load	Permissible shear load	Required edge distance (with one edge) for		Required spacing for	Min. spacing	Min. edge distance
							Max. tension load c	Max. shear load c			
		h_{min} [mm]	h_{ef} [mm]	T_{inst} [Nm]	$N_{perm}^{4)}$ [kN]	$V_{perm}^{4)}$ [kN]	[mm]	[mm]	Max. Load s [mm]	$s_{min}^{5)6)}$ [mm]	$c_{min}^{5)6)}$ [mm]
FZA 12 x 40 M6 I	8.8	100	40	8,5	3,6	4,1	40	60	120	40	35
	A4-70										
FZA 12 x 50 M6 I	A4-70	110	50	8,5	5,4	3,2	45	50	150	50	45
FZA 14 x 60 M8 I	8.8	130	60	15	9,3	5,4	75	70	180	60	55
	A4-70										
FZA 18 x 80 M10 I	8.8	160	80	30	9,6	5,6	70	70	240	80	70
	A4-70										
FZA 22 x 100 M12 I	8.8	200	100	60	19,0	13,2	110	120	300	100	100
	A4-70										
FZA 22 x 125 M12 I	8.8	250	125	60	19,0	13,2	125	125	375	125	125
	A4-70										

For the design the complete assessment ETA-98/0004 has to be considered.⁷⁾

¹⁾ The partial safety factors for material resistance as regulated in the ETA-98/0004 as well as a partial safety factor for load actions of $\gamma_L = 1,4$ are considered. As a single anchor counts e.g. an anchor with a spacing $s \geq 3 \cdot h_{ef}$ and an edge distance $c \geq 1,5 \cdot h_{ef}$. Accurate data see ETA-98/0004.

²⁾ For higher concrete strength classes up to C50/60 higher permissible loads may be possible.

³⁾ Drill method hammer drilling.

⁴⁾ For combinations of tensile loads, shear loads, bending moments as well as reduced edge distances or spacings (anchor groups) see ETA-98/0004.

⁵⁾ Minimum possible axial spacings resp. edge distance while reducing the permissible load.

⁶⁾ Minimum possible spacing resp. edge distance while reducing the permissible load for the required minimum member thickness. The combination of minimum edge distance and minimum spacing is not possible. One of both values has to be increased acc. ETA-98/0004.

⁷⁾ The given loads refer to the European Technical Assessment ETA-98/0004, issue date 12/09/2016. Design of the loads according ETAG 001, Annex C, Method A (for static resp. quasi-static loads).

The internally threaded anchor with low anchoring depth for individual fixings in cracked concrete



Emergency exit signs in tunnels



Air conditioning units

VERSIONS

- Zinc-plated steel
- Stainless steel
- Highly corrosion-resistant steel

BUILDING MATERIALS

Approved for:

- Concrete C20/25 to C50/60, cracked and non-cracked

Also suitable for:

- Concrete C12/15
- Natural stone with dense structure

CERTIFICATES



ADVANTAGES

- Hammerset anchor with Zykon undercut technology for individual fixings in cracked and non-cracked concrete.
- The combination of hammerset and ZYKON undercut anchor allows for individual fixings in cracked concrete.
- The special ZYKON undercut technology reduces the energy required for installation.
- The FZUB special drill allows for a fast installation by creating the undercut without having to change tools.
- The embossing that is applied when expanding the anchor secures the simple control of the anchoring.
- The almost expansion-free installation of the anchor allows small edge distances and axial spacing, thereby enabling flexible use.

APPLICATIONS

- Pipelines
- Ventilation systems
- Sprinkler systems
- Cable trays
- Suspended ceilings

FUNCTIONING

- The FZEA II is suitable for pre-positioned installation.
- The undercut drill hole is created using the special FZUB drill.
- Once the anchor has been placed in the drill hole, the expansion sleeve is expanded by the driving in of the internal expansion pin with the FZED Plus setting tool, and the undercut drill hole is filled with a positive fit.

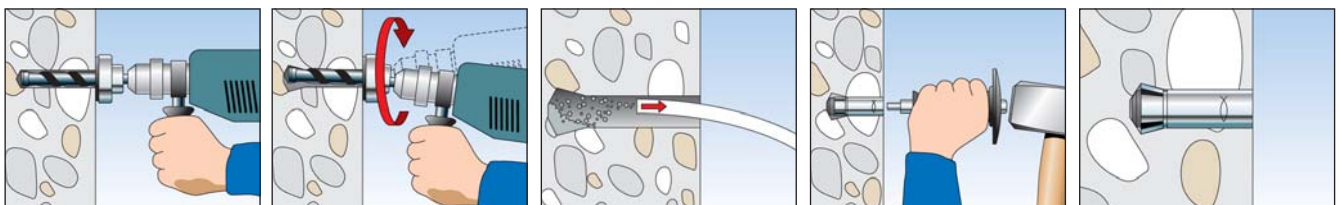

TECHNICAL DATA



Zykon-Hammerset anchor **FZEA II**

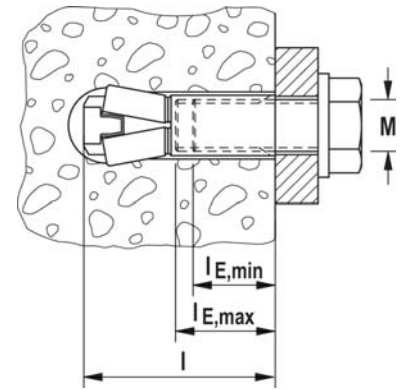

	Zinc-plated steel	Stainless steel	Highly corrosion resistant steel	Approval	Required drill bit FZUB	Required setting tool FZED plus	Length l [mm]	Internal thread A1	Max. bolt penetration l _{E,max} [mm]	Min. bolt penetration l _{E,min} [mm]	Sales unit [pcs]
Item	Art.-No.	Art.-No.	Art.-No.	ETA							
	gvz	A4	C								
FZEA II 10 x 40 M 8	047303	047306	047309 1)	■	10 x 40	FZED 10 plus	43	M 8	17	11	100
FZEA II 12 x 40 M10	047304	047307	047310 1)	■	12 x 40	FZED 12 plus	43	M 10	19	13	100
FZEA II 14 x 40 M12	047305	047308	—	■	14 x 40	FZED 14 plus	43	M 12	21	15	50

1) Delivery on request.

ACCESSORIES



Drill bit **FZUB**

Item	Art.-No.	Matching anchor type	Sales unit [pcs]
FZUB 10 x 40	060622	FZEA II 10 x 40, FZA 10 x 40 M6	1
FZUB 12 x 40	060623	FZEA II 12 x 40, FZA 12 x 40 M8	1
FZUB 14 x 40	060624	FZEA II 14 x 40, FZA 14 x 40	1

ACCESSORIES



Setting tool **FZED plus**

Item	Art.-No.	Matching anchor type	Sales unit [pcs]
FZED 10 plus	044642	FZEA II 10 x 40 M8	1
FZED 12 plus	044643	FZEA II 12 x 40 M10	1
FZED 14 plus	044644	FZEA II 14 x 40 M12	1

LOADS

ZYKON Hammer set Anchor FZEA II

zinc plated steel / stainless steel / high corrosion resistant steel

Permissible loads of a single anchor in cracked normal concrete (concrete tension zone) of strength class C20/25 (~B25) ^{1) 2) 3) 8)}										Minimum spacings while reducing the load									
Type	Screw material resp. screw surface	Minimum member thickness h_{min} [mm]	Effective anchorage depth h_{ef} [mm]	Maximum installation torque T_{max} [Nm]	Permissible tensile load $N_{perm}^{4)}$ [kN]	Permissible shear load $V_{perm}^{4)}$ [kN]	Required edge distance (with one edge) for		Required spacing for Max. Load s [mm]	Min. spacing $s_{min}^{5) 6)}$ [mm]	Min. edge distance $c_{min}^{5) 6)}$ [mm]								
							Max. tension load c [mm]	Max. shear load c [mm]											
FZEA II 10 x 40 M8	5.6	80	40	10	1,6	3,7	40	85	120	40	40								
	5.8																		
	8.8			15								4,7	115						
	A4-70																		
	C-70													5,6	135				
FZEA II 12 x 40 M10	5.6	80	40	15	3,0	5,6	65	135	120	45	45								
	5.8																		
	8.8			20								20	3,0	5,6	65	135	120	45	45
	A4-70																		
	C-70																		
FZEA II 14 x 40 M12	5.6	80	40	20	3,6	5,6	85	130	120	50	50								
	5.8																		
	8.8			40								20	3,6	5,6	85	130	120	50	50
	A4-70																		
	C-70																		

For the design the complete assessment ETA-06/0271 has to be considered.⁷⁾

¹⁾ The partial safety factors for material resistance as regulated in the ETA-06/0271 as well as a partial safety factor for load actions of $\gamma_F = 1,4$ are considered. As a single anchor counts e.g. an anchor with a spacing $s \geq 3 \cdot h_{ef}$ and an edge distance $c \geq 1,5 \cdot h_{ef}$. Accurate data see ETA-06/0271.

²⁾ For higher concrete strength classes up to C50/60 higher permissible loads may be possible.

³⁾ Drill method hammer drilling.

⁴⁾ For combinations of tensile loads, shear loads, bending moments as well as reduced edge distances or spacings (anchor groups) see ETA-06/0271.

⁵⁾ Minimum possible axial spacings resp. edge distance while reducing the permissible load.

⁶⁾ Minimum possible spacing resp. edge distance while reducing the permissible load for the required minimum member thickness. The combination of minimum edge distance and minimum spacing is not possible. One of both values has to be increased acc. ETA-06/0271.

⁷⁾ The given loads refer to the European Technical Assessment ETA-06/0271, issue date 30/11/2016. Design of the loads according ETAG 001, Annex C, Method A (for static resp. quasi-static loads).

⁸⁾ A reinforcement in the concrete to prevent splitting is required. The width of the cracks has to be limited under consideration of the splitting forces at $w_k \sim 0,3\text{mm}$.

High performance steel anchors 4

LOADS

ZYKON Hammer set Anchor FZEA II

zinc plated steel / stainless steel / high corrosion resistant steel

Permissible loads of a single anchor in non-cracked normal concrete (concrete compression zone) of strength class C20/25 (~B25) ^{1) 2) 3)}										Minimum spacings while reducing the load			
Type	Screw material resp. screw surface	Minimum member thickness h_{min} [mm]	Effective anchorage depth h_{ef} [mm]	Maximum installation torque T_{max} [Nm]	Permissible tensile load $N_{perm}^{4)}$ [kN]	Permissible shear load $V_{perm}^{4)}$ [kN]	Required edge distance (with one edge) for		Required spacing for Max. Load s [mm]	Min. spacing $s_{min}^{5) 6)}$ [mm]	Min. edge distance $c_{min}^{5) 6)}$ [mm]		
							Max. tension load c [mm]	Max. shear load c [mm]					
FZEA II 10 x 40 M8	5.6	80	40	10	3,6	3,7	55	60	120	40	40		
	5.8												
	8.8			15								4,7	75
	A4-70												
C-70	5,7	95											
FZEA II 12 x 40 M10	5.6	80	40	15	3,6	6,1	55	100	120	45	45		
	5.8												
	8.8			20								7,8	130
	A4-70												
C-70	7,9	135											
FZEA II 14 x 40 M12	5.6	80	40	20	3,6	7,9	55	130	120	50	50		
	5.8												
	8.8			40								7,9	130
	A4-70												
C-70	7,9	130											

For the design the complete assessment ETA-06/0271 has to be considered.⁷⁾

¹⁾ The partial safety factors for material resistance as regulated in the ETA-06/0271 as well as a partial safety factor for load actions of $\gamma_F = 1,4$ are considered. As an single anchor counts e.g. an anchor with a spacing $s \geq 3 \cdot h_{ef}$ and an edge distance $c \geq 1,5 \cdot h_{ef}$. Accurate data see ETA-06/0271.

²⁾ For higher concrete strength classes up to C50/60 higher permissible loads may be possible.

³⁾ Drill method hammer drilling.

⁴⁾ For combinations of tensile loads, shear loads, bending moments as well as reduced edge distances or spacings (anchor groups) see ETA-06/0271.

⁵⁾ Minimum possible axial spacings resp. edge distance while reducing the permissible load.

⁶⁾ Minimum possible spacing resp. edge distance while reducing the permissible load for the required minimum member thickness. The combination of minimum edge distance and minimum spacing is not possible. One of both values has to be increased acc. ETA-06/0271.

⁷⁾ The given loads refer to the European Technical Assessment ETA-06/0271, issue date 30/11/2016. Design of the loads according ETAG 001, Annex C, Method A (for static resp. quasi-static loads).

The high-performance concrete screw for absolute installation ease

High performance steel anchors 4

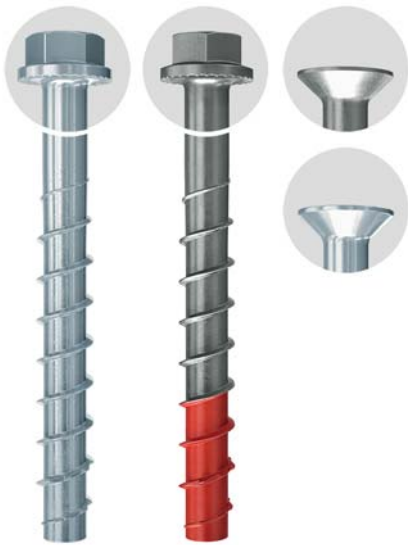

Inclined supports



Banisters

VERSIONS

- Zinc-plated steel
- Stainless steel A4

BUILDING MATERIALS

Approved for:

- Concrete C20/25 to C50/60, cracked and non-cracked

Also suitable for:

- Concrete C12/15
- Solid building materials
- Masonry with a dense structure

CERTIFICATES

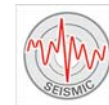

ADVANTAGES

- With up to 3 embedment depths, the ULTRACUT FBS II allows for the same screw to be used for different component thicknesses.
- Unique saw-tooth geometry cuts quickly into the concrete - also in multiple use and reinforced concrete.
- The short ULTRACUT FBS II, with a reduced embedment depth, allows for a short drill hole depth and fast installation which makes it an efficient choice for many applications.
- The performance categories seismic C1 and C2 ensure that the strictest of safety standards and earthquake specifications can be fulfilled.
- For the zinc-plated steel version the checking gauge allows for reuse covered by the approval.
- The specially hardened red tip of the stainless steel A4 version provides faster and more secure installation.
- The stainless steel concrete screw guarantees a high level of corrosion resistance especially for wet conditions and in outdoor areas.

APPLICATIONS

- Guard rails
- Consoles/Base plates
- Metal profiles
- Steel constructions
- Façades
- Protection barriers
- Results/beam anchors
- Shuttering props (only FBS II zinc-plated steel)
- Temporary anchoring, e.g. of building site equipment (only FBS II zinc-plated steel)

FUNCTIONING

- The ULTRACUT FBS II is recommended for the push-through installation.
- Drill holes do not need to be cleaned during vertical installation (ceiling and floor). For floor fixings the hole must be drilled 3x drill hole diameter deeper.
- The approved adjustment for the concrete screws allows the screw to be unscrewed twice for a total length of 20 mm, to place maximum 10 mm packing below the base plates or to align the attached part, and then to tighten the screw again.
- We recommend using a tangential impact screwdriver with a suitable impact screwdriver socket or an internal torx drive.
- The screw is installed correctly when the screw head sits flush on the fixture (visual setting control).

INSTALLATION

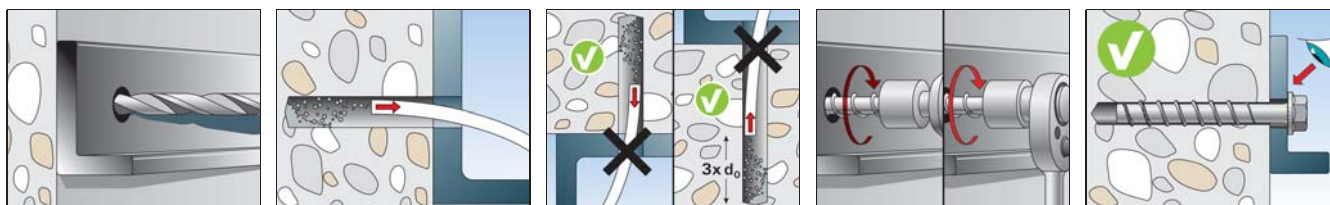

FIXTURE ADJUSTMENT

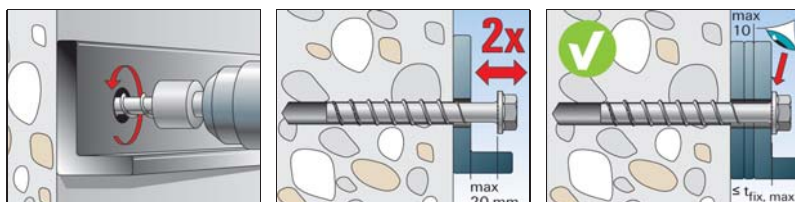

ADDITIONAL FOR SEISMIC

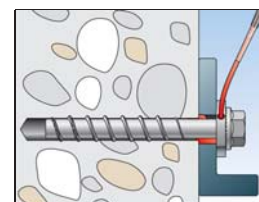

TECHNICAL DATA



ULTRACUT FBS II US - hexagon head with integral washer

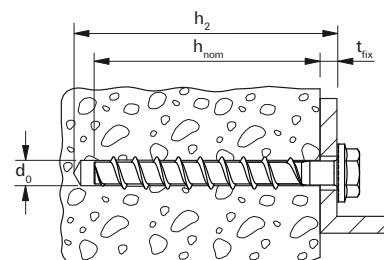

Item	Art.-No.	Approval ETA	Drill hole diameter	Min. drill hole depth for fixings	Screw	Screw-in depth with fixture thickness	Screw-in depth with fixture thickness	Screw-in depth with fixture thickness	Drive	Sales unit
			d ₀ [mm]	h ₂ [mm]	d _a x l _s [mm]	h _{nom1} / t _{fix} [mm]	h _{nom2} / t _{fix} [mm]	h _{nom3} / t _{fix} [mm]		[pcs]
ULTRACUT FBS II 8x55 5/- US TX	536851	■	8	65	10 x 55	50 / 5	- / -	- / -	TX40/SW13	50
ULTRACUT FBS II 8x70 20/5 US TX	536852	■	8	80	10 x 70	50 / 20	- / -	65 / 5	TX40/SW13	50
ULTRACUT FBS II 8x80 30/15 US TX	536853	■	8	90	10 x 80	50 / 30	- / -	65 / 15	TX40/SW13	50
ULTRACUT FBS II 8x90 40/25 US TX	536854	■	8	100	10 x 90	50 / 40	- / -	65 / 25	TX40/SW13	50
ULTRACUT FBS II 8x100 50/35 US TX	536855	■	8	110	10 x 100	50 / 50	- / -	65 / 35	TX40/SW13	50
ULTRACUT FBS II 8x110 60/45 US TX	536856	■	8	120	10 x 110	50 / 60	- / -	65 / 45	TX40/SW13	50
ULTRACUT FBS II 8x130 80/65 US TX	536857	■	8	140	10 x 130	50 / 80	- / -	65 / 65	TX40/SW13	50
ULTRACUT FBS II 10x60 5/-/- US	536858	■	10	70	12 x 60	55 / 5	- / -	- / -	SW 15	50
ULTRACUT FBS II 10x70 15/5/- US	536859	■	10	80	12 x 70	55 / 15	65 / 5	- / -	SW 15	50
ULTRACUT FBS II 10x80 25/15/- US	536860	■	10	90	12 x 80	55 / 25	65 / 15	- / -	SW 15	50
ULTRACUT FBS II 10x90 35/25/5 US	536861	■	10	100	12 x 90	55 / 35	65 / 25	85 / 5	SW 15	50
ULTRACUT FBS II 10x100 45/35/15 US	536862	■	10	110	12 x 100	55 / 45	65 / 35	85 / 15	SW 15	50
ULTRACUT FBS II 10x120 65/55/35 US	536863	■	10	130	12 x 120	55 / 65	65 / 55	85 / 35	SW 15	50
ULTRACUT FBS II 10x140 85/75/55 US	536864	■	10	150	12 x 140	55 / 85	65 / 75	85 / 55	SW 15	50
ULTRACUT FBS II 10x160 105/95/75 US	536865	■	10	170	12 x 160	55 / 105	65 / 95	85 / 75	SW 15	50
ULTRACUT FBS II 10x200 145/135/115 US	536866	■	10	210	12 x 200	55 / 145	65 / 135	85 / 115	SW 15	20
ULTRACUT FBS II 10x230 175/165/145 US	536867	■	10	240	12 x 230	55 / 175	65 / 165	85 / 145	SW 15	20
ULTRACUT FBS II 10x260 205/195/175 US	536868	■	10	270	12 x 260	55 / 205	65 / 195	85 / 175	SW 15	20
ULTRACUT FBS II 12x70 10/-/- US	536869	■	12	80	14 x 70	60 / 10	- / -	- / -	SW 17	20
ULTRACUT FBS II 12x85 25/10/- US	536870	■	12	95	14 x 85	60 / 25	75 / 10	- / -	SW 17	20
ULTRACUT FBS II 12x110 50/35/10 US	536871	■	12	120	14 x 110	60 / 50	75 / 35	100 / 10	SW 17	20
ULTRACUT FBS II 12x130 70/55/30 US	536872	■	12	140	14 x 130	60 / 70	75 / 55	100 / 30	SW 17	20
ULTRACUT FBS II 12x150 90/75/50 US	536873	■	12	160	14 x 150	60 / 90	75 / 75	100 / 50	SW 17	20
ULTRACUT FBS II 14x75 10/-/- US	536874	■	14	90	16 x 75	65 / 10	- / -	- / -	SW 21	20
ULTRACUT FBS II 14x95 30/10/- US	536875	■	14	110	16 x 95	65 / 30	85 / 10	- / -	SW 21	20
ULTRACUT FBS II 14x100 35/15/- US	536876	■	14	115	16 x 100	65 / 35	85 / 15	- / -	SW 21	20
ULTRACUT FBS II 14x125 60/40/10 US	536877	■	14	140	16 x 125	65 / 60	85 / 40	115 / 10	SW 21	10
ULTRACUT FBS II 14x150 85/65/35 US	536878	■	14	165	16 x 150	65 / 85	85 / 65	115 / 35	SW 21	10

TECHNICAL DATA



ULTRACUT FBS II SK - countersunk head

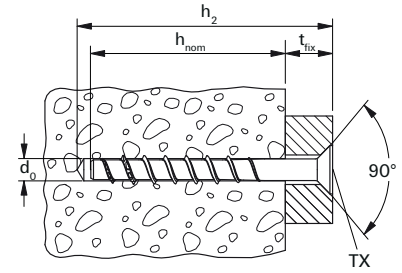

4 High performance steel anchors

Item	Art.-No.	Approval ETA	Drill hole diameter	Min. drill hole depth for through fixings	Screw	Screw-in depth with fixture thickness	Screw-in depth with fixture thickness	Screw-in depth with fixture thickness	Drive	Sales unit [pcs]
			d_0 [mm]	h_2 [mm]	$d_a \times l_s$ [mm]	h_{nom1} / t_{fix} [mm]	h_{nom2} / t_{fix} [mm]	h_{nom3} / t_{fix} [mm]		
ULTRACUT FBS II 8x60 10/- SK	536880	■	8	70	10 x 60	50 / 10	- / -	- / -	TX40	50
ULTRACUT FBS II 8x80 30/15 SK	536881	■	8	90	10 x 80	50 / 30	- / -	65 / 15	TX40	50
ULTRACUT FBS II 8x90 40/25 SK	536882	■	8	100	10 x 90	50 / 40	- / -	65 / 25	TX40	50
ULTRACUT FBS II 10x65 10/-/- SK	536884	■	10	75	12 x 65	55 / 10	- / -	- / -	TX50	50
ULTRACUT FBS II 10x80 25/15/- SK	536885	■	10	90	12 x 80	55 / 25	65 / 15	- / -	TX50	50
ULTRACUT FBS II 10x95 40/30/10 SK	536886	■	10	105	12 x 95	55 / 40	65 / 30	85 / 10	TX50	50
ULTRACUT FBS II 10x100 45/35/15 SK	536887	■	10	110	12 x 100	55 / 45	65 / 35	85 / 15	TX50	50
ULTRACUT FBS II 10x120 65/55/35 SK	536888	■	10	130	12 x 120	55 / 65	65 / 55	85 / 35	TX50	50

TECHNICAL DATA



ULTRACUT FBS II US A4 - hexagon head with molded washer, stainless steel A4



ULTRACUT FBS II SK A4 - countersunk head, stainless steel A4

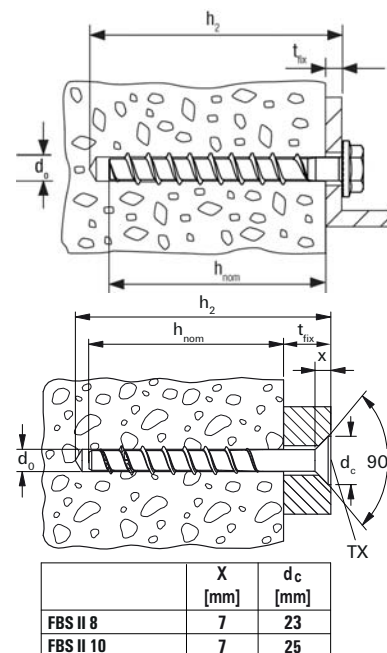

Item	Art.-No.	Approval ETA	Drill hole diameter	Min. drill hole depth for through fixings	Screw length	Screw-in depth with fixture thickness	Screw-in depth with fixture thickness	Screw-in depth with fixture thickness	Drive	Sales unit [pcs]
			d ₀ [mm]	h ₂ [mm]	l _s [mm]	h _{nom1} / t _{fix} [mm]	h _{nom3} / t _{fix} [mm]	h _{nom2} / t _{fix} [mm]		
A4										
FBS II 8 x 60 10/- US A4	543565	■	8	70	60	50 / 10	- / -	- / -	SW 13	50
FBS II 8 x 70 5/- US A4	543566	■	8	80	70	50 / 20	65 / 5	- / -	SW 13	50
FBS II 8 x 80 15/- US A4	543567	■	8	90	80	50 / 30	65 / 15	- / -	SW 13	50
FBS II 8 x 90 25/- US A4	543568	■	8	100	90	50 / 40	65 / 25	- / -	SW 13	50
FBS II 10 x 60 5/-/- US A4	543569	■	10	70	60	55 / 5	- / -	- / -	SW 15	50
FBS II 10 x 70 15/5/- US A4	543570	■	10	80	70	55 / 15	- / -	65 / 5	SW 15	50
FBS II 10 x 80 25/15/- US A4	543571	■	10	90	80	55 / 25	- / -	65 / 15	SW 15	50
FBS II 10 x 90 5/- US A4	543572	■	10	100	90	55 / 35	85 / 5	65 / 25	SW 15	50
FBS II 10 x 100 15/- US A4	543573	■	10	110	100	55 / 45	85 / 15	65 / 35	SW 15	50
FBS II 10 x 120 35/- US A4	543574	■	10	130	120	55 / 65	85 / 35	65 / 55	SW 15	50
FBS II 12 x 70 10/-/- US A4	543575	■	12	80	70	60 / 10	- / -	- / -	SW 17	20
FBS II 12 x 85 25/10/- US A4	543576	■	12	95	85	60 / 25	- / -	75 / 10	SW 17	20
FBS II 12 x 110 10/- US A4	543577	■	12	120	110	60 / 50	100 / 10	75 / 35	SW 17	50
FBS II 12 x 130 30/- US A4	543578	■	12	140	130	60 / 70	100 / 30	75 / 55	SW 17	20
FBS II 8 x 60 10/- SK A4	543579	■	8	70	60	50 / 10	- / -	- / -	TX40	50
FBS II 8 x 80 15/- SK A4	543580	■	8	90	80	50 / 30	65 / 15	- / -	TX40	50
FBS II 8 x 90 25/- SK A4	543581	■	8	100	90	50 / 40	65 / 25	- / -	TX40	50
FBS II 10 x 65 10/-/- SK A4	543582	■	10	75	65	55 / 10	- / -	- / -	TX50	50
FBS II 10 x 80 25/15/- SK A4	543583	■	10	90	80	55 / 25	- / -	65 / 15	TX50	50
FBS II 10 x 95 10/- SK A4	543584	■	10	105	95	55 / 40	85 / 10	65 / 30	TX50	50
FBS II 10 x 100 15/- SK A4	543585	■	10	110	100	55 / 45	85 / 15	65 / 35	TX50	50
FBS II 10 x 120 35/- SK A4	543586	■	10	130	120	55 / 65	85 / 35	65 / 55	TX50	50

ACCESSORIES



Checking gauge FUP



Nut SW



Nut TX



FMB T40 Maxx Bit



Profi-bit FPB T50 5/16"

Item	Art.-No.	Internal diameter	Drive	Match	Sales unit [pcs]
		D [mm]			
Checking gauge FUP 8	537200	9,9	–	FBS II 8	1
Checking gauge FUP 10	537201	12,0	–	FBS II 10	1
Checking gauge FUP 12	537202	13,0	–	FBS II 12	1
Checking gauge FUP 14	537203	15,0	–	FBS II 14	1
Nut SW13	538578	–	1/2" / SW13	FBS II 8	1
Nut SW15	538579	–	1/2" / SW15	FBS II 10	1
Nut SW17	538580	–	1/2" / SW17	FBS II 12	1
Nut SW21	538581	–	1/2" / SW21	FBS II 14	1
Nut TX40	538575 1)	–	1/2" - 1/4"	FBS II 8 / FBS II 8 SK	1
Nut TX50	538576 2)	–	1/2" - 5/16"	FBS II 10 / FBS II 10 SK	1
FMB T40 Maxx Bit W 5	533159	–	TX40	FBS II 8 / FBS II 8 SK	10
FPB Profi-Bit T50 5/16"	538574	–	TX50	FBS II 10 SK	1

1) Suitable for FMB T40 Maxx Bit

2) Suitable for FPB Profi-Bit T50 5/16"

ACCESSORIES



Filling washer FFD



Washer U

Item	Art.-No.	Internal diameter	External-Ø	Match	Sales unit [pcs]
		D [mm]	d [mm]		
FFD 22 x 9 x 6	547515	9,0	22	FBS II 6	4
FFD 26 x 12 x 6	538458	12,0	26	FBS II 8	4
FFD 30 x 14 x 6	538459	14,2	30	FBS II 10 / FBS II 12	4
FFD 38 x 19 x 7	538460	19,2	38	FBS II 14	4
FFD 30x14x6 A4	541987	14,0	30	FBS II 10 A4 / FBS II 12 A4	4
Washer for FBS 10	520471	13,5	44	FBS II 10	50

High performance steel anchors 4

INSTALLATION DATA - CONCRETE C20/25 - C50/60

Type US

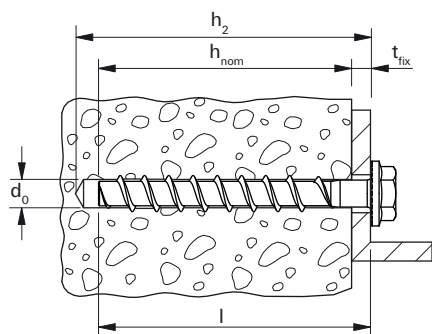

Type SK

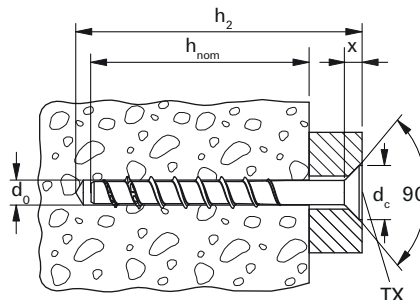

	X [mm]	dc [mm]
ULTRACUT FBS II 8	6	20
ULTRACUT FBS II 10	7	23

Concrete screw ULTRACUT FBS II 8-14			8	10	12	14
Drill hole diameter	d0	[mm]	8	10	12	14
Nominal screw-in depth	hnom1	[mm]	50	55	60	65
	hnom2	[mm]	-	65	75	85
	hnom3	[mm]	65	85	100	115
Drill hole depth (push-through installation)	h2 ≥	[mm]	l + 10	l + 10	l + 10	l + 15
Clearance hole diameter	df		10,6 - 12	12,8 - 14	14,8 - 16	16,9 - 18
Max. torque for installation with impact screw driver in concrete	T _{imp, max}		600	650	650	650
Width across flat	SW		13	15	17	21
Drive	Torx		T40 (SK a. US)	T50 (SK)	-	-

INSTALLATION DATA - MASONRY

Concrete screw ULTRACUT FBS II 8-14					
Building material	Compressive strength class [N/mm ²]	Size	[mm]	8	10
		hnom	[mm]	65	85
Solid clay brick (EN771-1)	≥ 12	T _{inst}	[Nm]	10	10
Solid sand-lime brick (EN771-2)	≥ 12	T _{inst}	[Nm]	15	15
Aerated concrete (EN771-4)	≥ 6	T _{inst}	[Nm]	5	5

INSTALLATION OF CONCRETE SCREWS (USE A CORDLESS OR CABLED IMPACT WRENCH)

Concrete screw ULTRACUT FBS II 8-14	Maximum torque gvz [Nm]	Maximum torque A4 [Nm]
FBS II 8	600	450
FBS II 10	650	450
FBS II 12	650	650
FBS II 14	650	-

*1 The values apply to concrete strength of approx. 40N/mm², for other concrete strength classes the values may differ.
The conversion of nominal output into effective tightening torque varies from machine to machine - always therefore use torque control.

LOADS

Concrete screw ULTRACUT FBS II

zinc plated steel

Permissible loads of a single anchor in cracked normal concrete (concrete tension zone) of strength class C20/25 (~B25) ^{1) 2) 3) 10)}											Minimum spacings while reducing the load		
Type	Material fixing element	Minimum member thickness	Screw-in depth		Maximum installation torque	Installation torque	Permissible tensile load	Permissible shear load	Required edge distance (with one edge) for		Required spacing for	Min. spacing	Min. edge distance
			h_{min} [mm]	h_{nom} [mm]					Max. tension load c [mm]	Max. shear load c [mm]			
FBS II 6x40 ⁵⁾	gvz	80	40	10	450	1,2	4,3	35	110	100	35	35	
FBS II 6x45 ⁵⁾	gvz	90	45	10	450	1,7	4,3	35	105	110	35	35	
FBS II 6x50 ⁵⁾	gvz	90	50	10	450	1,9	4,3	35	100	120	35	35	
FBS II 6x55 ⁵⁾	gvz	100	55	10	450	2,4	6,3	35	145	135	35	35	
FBS II 8x50	gvz	100	50	0	600	2,9	4,3	35	90	120	35	35	
FBS II 8x65	gvz	120	65	0	600	5,7	9,0	70	180	160	35	35	
FBS II 10x55	gvz	100	55	0	650	4,3	4,8	55	100	130	40	40	
FBS II 10x65	gvz	120	65	0	650	5,7	12,5	70	250	155	40	40	
FBS II 10x85	gvz	140	85	0	650	9,6	16,6	105	305	205	40	40	
FBS II 12x60	gvz	110	60	0	650	5,5	11,0	70	230	145	50	50	
FBS II 12x75	gvz	130	75	0	650	8,0	15,2	90	290	180	50	50	
FBS II 12x100	gvz	150	100	0	650	12,5	20,3	125	355	245	50	50	
FBS II 14x65	gvz	120	65	0	650	6,1	12,1	75	235	150	60	60	
FBS II 14x85	gvz	140	85	0	650	9,4	18,8	100	340	205	60	60	
FBS II 14x115	gvz	180	115	0	650	15,4	29,4	140	465	280	60	60	

For the design the complete assessment ETA-15/0352 has to be considered.⁹⁾

¹⁾ The partial safety factors for material resistance as regulated in the ETA-15/0352 as well as a partial safety factor for load actions of $\gamma_L = 1,4$ are considered. As an single anchor counts e.g. an anchor with a spacing $s \geq 3 \cdot h_{ef}$ and an edge distance $c \geq 1,5 \cdot h_{ef}$. Accurate data see ETA-15/0352.

²⁾ For higher concrete strength classes up to C50/60 higher permissible loads may be possible.

³⁾ Drill method hammer drilling resp. hollow drilling. For further allowable drill methods see ETA-15/0352.

⁴⁾ The anchorage depths smaller than 40 mm are only allowed for single anchors as part of a multiple fixing of non-structural systems.

⁵⁾ Diamond drilling not permitted.

⁶⁾ Maximum allowable torque for installation with any tangential impact screw driver.

⁷⁾ For combinations of tensile loads and shear loads or for shear loads with lever arm (bending moments) as well as reduced edge distances or spacings (anchor groups) we recommend to use our anchor design software C-FIX.

⁸⁾ Minimum possible axial spacings resp. edge distance while reducing the permissible load.

⁹⁾ The given loads refer to the European Technical Assessment ETA-15/0352, issue date 30/10/2018. Design of the loads according ETAG 001, Annex C, Method A (for static resp. quasi-static loads).

¹⁰⁾ A reinforcement in the concrete to prevent splitting is required. The width of the cracks has to be limited under consideration of the splitting forces at $w_k \sim 0,3$ mm.

LOADS

Concrete screw ULTRACUT FBS II

zinc plated steel

Permissible loads of a single anchor in non-cracked normal concrete (concrete compression zone) of strength class C20/25 (~B25) ^{1) 2) 3)}											Minimum spacings while reducing the load		
Type	Material fixing element	Minimum member thickness	Screw-in depth		Maximum installation torque	Installation torque	Permissible tensile load	Permissible shear load	Required edge distance (with one edge) for		Required spacing for	Min. spacing	Min. edge distance
			h_{min} [mm]	h_{nom} [mm]					Max. tension load c [mm]	Max. shear load c [mm]			
FBS II 6x40 ⁵⁾	gvz	80	40	10	450	3,8	4,3	40	75	100	35	35	
FBS II 6x45 ⁵⁾	gvz	90	45	10	450	4,8	4,3	50	70	110	35	35	
FBS II 6x50 ⁵⁾	gvz	90	50	10	450	5,7	4,3	55	70	120	35	35	
FBS II 6x55 ⁵⁾	gvz	100	55	10	450	6,4	6,3	60	100	135	35	35	
FBS II 8x50	gvz	100	50	0	600	6,1	6,1	60	90	120	35	35	
FBS II 8x65	gvz	120	65	0	600	9,0	9,0	80	125	160	35	35	
FBS II 10x55	gvz	100	55	0	650	6,8	6,8	65	100	130	40	40	
FBS II 10x65	gvz	120	65	0	650	8,8	14,0	80	195	155	40	40	
FBS II 10x85	gvz	140	85	0	650	13,5	16,6	105	210	205	40	40	
FBS II 12x60	gvz	110	60	0	650	7,7	15,2	70	220	145	50	50	
FBS II 12x75	gvz	130	75	0	650	11,2	15,2	90	195	180	50	50	
FBS II 12x100	gvz	150	100	0	650	17,5	20,3	125	240	245	50	50	

LOADS

Concrete screw ULTRACUT FBS II

zinc plated steel

Permissible loads of a single anchor in non-cracked normal concrete (concrete compression zone) of strength class C20/25 (~B25) ^{1) 2) 3)}											Minimum spacings while reducing the load	
Type	Material fixing element	Minimum member thickness	Screw-in depth	Maximum installation torque	Installation torque	Permissible tensile load	Permissible shear load	Required edge distance (with one edge) for		Required spacing for	Min. spacing	Min. edge distance
								Max. tension load	Max. shear load			
		h_{min}	h_{nom}	T_{max}	$T_{imp,max}^6)$	$N_{perm}^7)$	$V_{perm}^7)$	c	c	s_{cr}	$s_{min}^8)$	$c_{min}^8)$
		[mm]	[mm]	[Nm]	[Nm]	[kN]	[kN]	[mm]	[mm]	[mm]	[mm]	[mm]
FBS II 14x65	gvz	120	65	0	650	8,5	17,0	75	235	150	60	60
FBS II 14x85	gvz	140	85	0	650	13,2	22,1	100	275	205	60	60
FBS II 14x115	gvz	180	115	0	650	21,6	29,4	140	315	280	60	60

For the design the complete assessment ETA-15/0352 has to be considered.⁹⁾

- ¹⁾ The partial safety factors for material resistance as regulated in the ETA-15/0352 as well as a partial safety factor for load actions of $\gamma_L = 1,4$ are considered. As an single anchor counts e.g. an anchor with a spacing $s \geq 3 \cdot h_{ef}$ and an edge distance $c \geq 1,5 \cdot h_{ef}$. Accurate data see ETA-15/0352.
- ²⁾ For higher concrete strength classes up to C50/60 higher permissible loads may be possible.
- ³⁾ Drill method hammer drilling resp. hollow drilling. For further allowable drill methods see ETA-15/0352.
- ⁴⁾ The anchorage depths smaller than 40 mm are only allowed for single anchors as part of a multiple fixing of non-structural systems.
- ⁵⁾ Diamond drilling not permitted.
- ⁶⁾ Maximum allowable torque for installation with any tangential impact screw driver.
- ⁷⁾ For combinations of tensile loads and shear loads or for shear loads with lever arm (bending moments) as well as reduced edge distances or spacings (anchor groups) we recommend to use our anchor design software C-FIX.
- ⁸⁾ Minimum possible axial spacings resp. edge distance while reducing the permissible load.
- ⁹⁾ The given loads refer to the European Technical Assessment ETA-15/0352, issue date 30/10/2018. Design of the loads according ETAG 001, Annex C, Method A (for static resp. quasi-static loads).

LOADS

Concrete screw with hexagon head and washer ULTRACUT FBS II A4 US

stainless steel

Permissible loads of a single anchor in cracked normal concrete (concrete tension zone) of strength class C20/25 (~B25) ^{1) 2) 3) 8)}											Minimum spacings while reducing the load	
Type	Material fixing element	Minimum member thickness	Screw-in depth	Installation torque	Permissible tensile load	Permissible shear load	Required edge distance (with one edge) for		Required spacing for	Min. spacing	Min. edge distance	
							Max. tension load	Max. shear load				Max. Load
		h_{min}	h_{nom}	$T_{imp,max}^4)$	$N_{perm}^5)$	$V_{perm}^5)$	c	c	s_{cr}	$s_{min}^6)$	$c_{min}^6)$	
		[mm]	[mm]	[Nm]	[kN]	[kN]	[mm]	[mm]	[mm]	[mm]	[mm]	
FBS II 8x50	A4	100	50	450	1,9	4,3	35	90	120	35	35	
FBS II 8x65	A4	120	65	450	4,3	6,4	45	125	160	35	35	
FBS II 10x55	A4	100	55	450	2,1	4,8	40	100	130	40	40	
FBS II 10x65	A4	120	65	450	2,9	6,2	40	115	155	40	40	
FBS II 10x85	A4	140	85	450	7,6	19,2	75	360	205	40	40	
FBS II 12x60	A4	110	60	650	2,1	5,5	50	105	145	50	50	
FBS II 12x75	A4	130	75	650	5,2	15,9	50	305	180	50	50	
FBS II 12x100	A4	150	100	650	12,5	25,0	125	445	245	50	50	

For the design the complete assessment ETA-17/0740 has to be considered.⁷⁾

- ¹⁾ The partial safety factors for material resistance as regulated in the ETA-17/0740 as well as a partial safety factor for load actions of $\gamma_F = 1,4$ are considered. As an single anchor counts e.g. an anchor with a spacing $s \geq 3 \cdot h_{ef}$ and an edge distance $c \geq 1,5 \cdot h_{ef}$. Accurate data see ETA-17/0740.
- ²⁾ For higher concrete strength classes up to C50/60 higher permissible loads may be possible.
- ³⁾ Drill method Hammer drilling resp. hollow drilling. For further allowable drill methods see ETA-17/0740.
- ⁴⁾ Maximum allowable torque for installation with any tangential impact screw driver.
- ⁵⁾ For combinations of tensile loads and shear loads or for shear loads with lever arm (bending moments) as well as reduced edge distances or spacings (anchor groups) we recommend to use our anchor design software C-FIX.
- ⁶⁾ Minimum possible axial spacings resp. edge distance while reducing the permissible load.
- ⁷⁾ The given loads refer to the European Technical Assessment ETA-17/0740, issue date 23/10/2018. Design of the loads according TR055/ETAG 001, Annex C, Method A (for static resp. quasi-static loads).
- ⁸⁾ A reinforcement in the concrete to prevent splitting is required. The width of the cracks has to be limited under consideration of the splitting forces at $w_k \sim 0,3$ mm.

LOADS

Concrete screw with hexagon head and washer ULTRACUT FBS II A4 US

stainless steel

Permissible loads of a single anchor in non-cracked normal concrete (concrete compression zone) of strength class C20/25 (~B25) ^{1) 2) 3)}										Minimum spacings while reducing the load	
Type	Material fixing element	Minimum member thickness h_{min} [mm]	Screw-in depth h_{nom} [mm]	Installation torque $T_{imp,max}^{4)}$ [Nm]	Permissible tensile load $N_{perm}^{5)}$ [kN]	Permissible shear load $V_{perm}^{5)}$ [kN]	Required edge distance (with one edge) for		Required spacing for Max. Load s_{cr} [mm]	Min. spacing $s_{min}^{6)}$ [mm]	Min. edge distance $c_{min}^{6)}$ [mm]
							Max. tension load c [mm]	Max. shear load c [mm]			
FBS II 8x50	A4	100	50	450	3,3	6,1	35	90	120	35	35
FBS II 8x65	A4	120	65	450	6,7	9,0	55	120	160	35	35
FBS II 10x55	A4	100	55	450	4,0	6,8	40	100	130	40	40
FBS II 10x65	A4	120	65	450	6,7	8,8	55	115	155	40	40
FBS II 10x85	A4	140	85	450	13,5	20,9	105	270	205	40	40
FBS II 12x60	A4	110	60	650	4,8	7,7	50	105	145	50	50
FBS II 12x75	A4	130	75	650	5,7	22,4	50	300	180	50	50
FBS II 12x100	A4	150	100	650	17,5	26,2	125	320	245	50	50

For the design the complete assessment ETA-17/0740 has to be considered. ⁷⁾

¹⁾ The partial safety factors for material resistance as regulated in the ETA-17/0740 as well as a partial safety factor for load actions of $\gamma_F = 1,4$ are considered. As an single anchor counts e.g. an anchor with a spacing $s \geq 3 \cdot h_{ef}$ and an edge distance $c \geq 1,5 \cdot h_{ef}$. Accurate data see ETA-17/0740.

²⁾ For higher concrete strength classes up to C50/60 higher permissible loads may be possible.

³⁾ Drill method Hammer drilling resp. hollow drilling. For further allowable drill methods see ETA-17/0740.

⁴⁾ Maximum allowable torque for installation with any tangential impact screw driver.

⁵⁾ For combinations of tensile loads and shear loads or for shear loads with lever arm (bending moments) as well as reduced edge distances or spacings (anchor groups) we recommend to use our anchor design software C-FIX.

⁶⁾ Minimum possible axial spacings resp. edge distance while reducing the permissible load.

⁷⁾ The given loads refer to the European Technical Assessment ETA-17/0740, issue date 23/10/2018. Design of the loads according TR055/ETAG 001, Annex C, Method A (for static resp. quasi-static loads).

LOADS

Concrete screw with countersunk head ULTRACUT FBS II A4 SK

stainless steel

Permissible loads of a single anchor in cracked normal concrete (concrete tension zone) of strength class C20/25 (~B25) ^{1) 2) 3) 8)}										Minimum spacings while reducing the load	
Type	Material fixing element	Minimum member thickness h_{min} [mm]	Screw-in depth h_{nom} [mm]	Installation torque $T_{imp,max}^{4)}$ [Nm]	Permissible tensile load $N_{perm}^{5)}$ [kN]	Permissible shear load $V_{perm}^{5)}$ [kN]	Required edge distance (with one edge) for		Required spacing for Max. Load s_{cr} [mm]	Min. spacing $s_{min}^{6)}$ [mm]	Min. edge distance $c_{min}^{6)}$ [mm]
							Max. tension load c [mm]	Max. shear load c [mm]			
FBS II 8x50	A4	100	50	450	1,9	4,3	35	90	120	35	35
FBS II 8x65	A4	120	65	450	4,3	6,4	45	125	160	35	35
FBS II 10x55	A4	100	55	450	2,1	4,8	40	100	130	40	40
FBS II 10x65	A4	120	65	450	2,9	6,2	40	115	155	40	40
FBS II 10x85	A4	140	85	450	7,6	19,2	75	360	205	40	40

For the design the complete assessment ETA-17/0740 has to be considered. ⁷⁾

¹⁾ The partial safety factors for material resistance as regulated in the ETA-17/0740 as well as a partial safety factor for load actions of $\gamma_F = 1,4$ are considered. As an single anchor counts e.g. an anchor with a spacing $s \geq 3 \cdot h_{ef}$ and an edge distance $c \geq 1,5 \cdot h_{ef}$. Accurate data see ETA-17/0740.

²⁾ For higher concrete strength classes up to C50/60 higher permissible loads may be possible.

³⁾ Drill method hammer drilling. For further allowable drill methods see ETA-17/0740.

⁴⁾ Maximum allowable torque for installation with any tangential impact screw driver.

⁵⁾ For combinations of tensile loads and shear loads or for shear loads with lever arm (bending moments) as well as reduced edge distances or spacings (anchor groups) we recommend to use our anchor design software C-FIX.

⁶⁾ Minimum possible axial spacings resp. edge distance while reducing the permissible load.

⁷⁾ The given loads refer to the European Technical Assessment ETA-17/0740, issue date 23/10/2018. Design of the loads according TR055/ETAG 001, Annex C, Method A (for static resp. quasi-static loads).

⁸⁾ A reinforcement in the concrete to prevent splitting is required. The width of the cracks has to be limited under consideration of the splitting forces at $w_k \sim 0,3$ mm.

LOADS

Concrete screw with countersunk head ULTRACUT FBS II A4 SK

stainless steel

Permissible loads of a single anchor in non-cracked normal concrete (concrete compression zone) of strength class C20/25 (~B25) ¹⁾²⁾³⁾										Minimum spacings while reducing the load	
Type	Material fixing element	Minimum member thickness h_{min} [mm]	Screw-in depth h_{nom} [mm]	Installation torque $T_{imp,max}^{4)}$ [Nm]	Permissible tensile load $N_{perm}^{5)}$ [kN]	Permissible shear load $V_{perm}^{5)}$ [kN]	Required edge distance (with one edge) for		Required spacing for Max. Load s_{cr} [mm]	Min. spacing $s_{min}^{6)}$ [mm]	Min. edge distance $c_{min}^{6)}$ [mm]
							Max. tension load c [mm]	Max. shear load c [mm]			
FBS II 8x50	A4	100	50	450	3,3	6,1	35	90	120	35	35
FBS II 8x65	A4	120	65	450	6,7	9,0	55	120	160	35	35
FBS II 10x55	A4	100	55	450	4,0	6,8	40	100	130	40	40
FBS II 10x65	A4	120	65	450	6,7	8,8	55	115	155	40	40
FBS II 10x85	A4	140	85	450	13,5	20,9	105	270	205	40	40

¹⁾ For the design the complete assessment ETA-17/0740 has to be considered. ⁷⁾

²⁾ The partial safety factors for material resistance as regulated in the ETA-17/0740 as well as a partial safety factor for load actions of $\gamma_F = 1,4$ are considered. As an single anchor counts e.g. an anchor with a spacing $s \geq 3 \cdot h_{ef}$ and an edge distance $c \geq 1,5 \cdot h_{ef}$. Accurate data see ETA-17/0740.

³⁾ For higher concrete strength classes up to C50/60 higher permissible loads may be possible.

⁴⁾ Drill method hammer drilling. For further allowable drill methods see ETA-17/0740.

⁵⁾ Maximum allowable torque for installation with any tangential impact screw driver.

⁶⁾ For combinations of tensile loads and shear loads or for shear loads with lever arm (bending moments) as well as reduced edge distances or spacings (anchor groups) we recommend to use our anchor design software C-FIX.

⁷⁾ Minimum possible axial spacings resp. edge distance while reducing the permissible load.

⁸⁾ The given loads refer to the European Technical Assessment ETA-17/0740, issue date 23/10/2018. Design of the loads according TR055/ETAG 001, Annex C, Method A (for static resp. quasi-static loads).

LOADS

Concrete screw ULTRACUT FBS II

Highest recommended loads ¹⁾³⁾ for a single anchor, resp. a fixing point ⁴⁾⁵⁾⁶⁾ in solid brick masonry.

Base material	Compressive strength [N/mm ²]	Type	ULTRACUT		
		Size	FBS II 8	FBS II 10	
		Anchoring depth h_{nom}	[mm]	65	85
Solid clay brick ⁹⁾ (EN771-1) $\geq 240 \times 113 \times 115$ mm	≥ 12	Frec ²⁾³⁾	[kN]	1,1	1,4
	≥ 20	Frec ²⁾³⁾⁷⁾	[kN]	1,6	1,6
Solid sand-lime brick ⁹⁾ (EN771-2) $\geq 240 \times 71 \times 115$ mm	≥ 12	Frec ²⁾³⁾⁷⁾	[kN]	1,2	1,2
	≥ 20	Frec ²⁾³⁾⁷⁾	[kN]	1,2	1,2
Aerated concrete (EN771-4) $\geq 499 \times 249 \times 120$ mm	≥ 6	Frec ²⁾³⁾	[kN]	0,7	0,9
Minimum spacing within anchor groups of 2 or 4 anchors		s_{min}	[mm]	80	
Minimum spacing between single anchors, resp. anchor groups		s_{min}	[mm]	80	
Minimum distance to the horizontal joint		$c_{min,v}^{8)}$	[mm]	20	
Minimum distance to the vertical joint		$c_{min,h}^{8)}$	[mm]	40	
Minimum distance to the free edge		$c_{min,free\ edge}^{8)}$	[mm]	200	
Tightening torque ¹⁰⁾	Solid clay brick ⁹⁾	Tighten	[Nm]	10	
	Solid sandlime brick ⁹⁾			15	
	Aerated concrete			5	

¹⁾ An appropriate safety factor is considered.

²⁾ The given loads apply to the given brick measures for masonry with superimposed load. Bigger brick sizes are minimum equal in case of the loads.

³⁾ The loads only apply to multiple fixings of non-load-bearing systems and are valid for tensile load, shear load and oblique load under any angle.

⁴⁾ On-site screw testing is recommended to validate technical data. If the joints are not visible 100% anchor testing is recommended due to the screws are only working in the bricks and not in the mortar joints.

⁵⁾ A fixing point can be a single anchor, 2 anchors or 4 anchors with a minimum spacing s_{min} . Anchor groups of 4 anchors are arranged in rectangular disposition.

⁶⁾ The fixing points have to be arranged in this way that there will be always maximum one fixing point arranged in one brick.

⁷⁾ Brick pull-out is decisive.

⁸⁾ The values $c_{min,v}$ and $c_{min,h}$ are only valid if the mortar joints are filled proper. Otherwise the joints has to be considered as free edges and $c_{min,free}$ is decisive. Minimum mortar strenght is M2.5

⁹⁾ The values are valid for unperforated solid bricks.

¹⁰⁾ The screw is screwed in with a cordless screwdriver, an impact screwdriver or by hand. The screwing process must be finished immediately when the screw head is in contact with the assembled object. The specified tightening torque must then be applied with a torque wrench.

The high-performance concrete screw for absolute installation ease

High performance steel anchors 4



Light, suspended pipelines



Suspended air-conditioners

VERSIONS

- Zinc-plated steel

BUILDING MATERIALS

Approved for:

- Concrete C20/25 to C50/60, cracked and non-cracked
- Prestressed hollow concrete ceilings C30/37 to C50/60 for the multiple use of non-load bearing systems

Also suitable for:

- Concrete C12/15
- Solid building materials
- Masonry with dense structure

CERTIFICATES

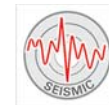
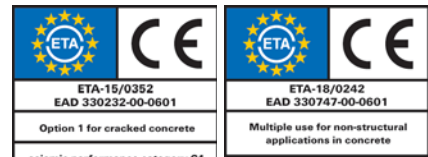

ADVANTAGES

- The first concrete screw with diameter 6 with variable embedment depth offers a flexible adaption of the embedment depth to the loads.
- The ETA assessment option 1 includes the use in cracked and non-cracked concrete for highest safety requirements.
- The first 6 mm diameter concrete screw with an ETA assessment for the C1 seismic performance category for additional safety standards.
- Different head designs offer a maximum of flexibility and a perfect adaptation to the application.
- The ULTRACUT FBS II 6 is approved for multiple use of non-load bearing systems and thereby ideal for the installation of pipe routes, cable trays and prestressed hollow concrete ceilings.

APPLICATIONS

- Pipeline routes
- Suspension for individual pipes
- Suspended mounting rails
- Prestressed concrete hollow core ceilings
- Cable trays
- Ventilation ducts
- Perforated tapes
- Air conditioning units

FUNCTIONING

- The ULTRACUT FBS II is recommended for the push-through / pre-positioned installation.
- Drill holes do not need to be cleaned during vertical installation (ceiling and floor). For floor fixings the hole must be drilled 3x drill hole diameter deeper.
- The approved adjustment for the concrete screws allows the screw to be unscrewed twice for a total length of 20 mm, to place maximum 10 mm packing below the base plates or to align the attached part, and then to tighten the screw again.
- We recommend using a tangential impact screwdriver with a suitable impact screwdriver socket or an internal torx drive.
- The screw is installed correctly when the screw head sits flush on the fixture (visual setting control).

INSTALLATION

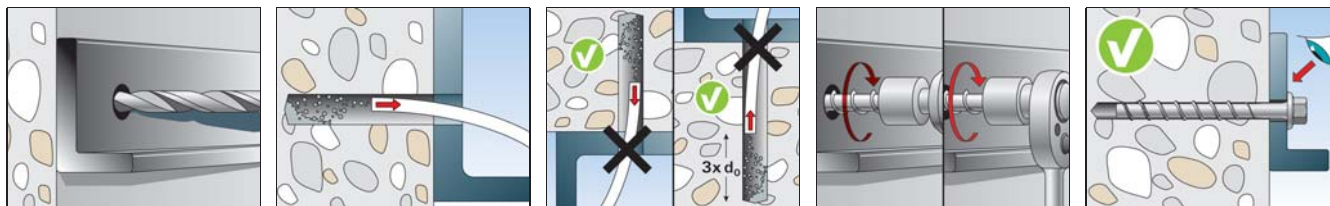

FIXTURE ADJUSTMENT

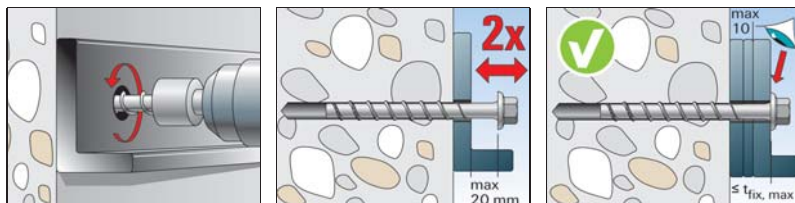

ADDITIONAL FOR SEISMIC

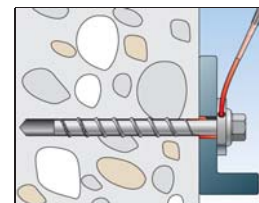

TECHNICAL DATA



ULTRACUT FBS II 6 P - panhead



ULTRACUT FBS II 6 SK - panhead



ULTRACUT FBS II 6 US - hexagon head with molded washer

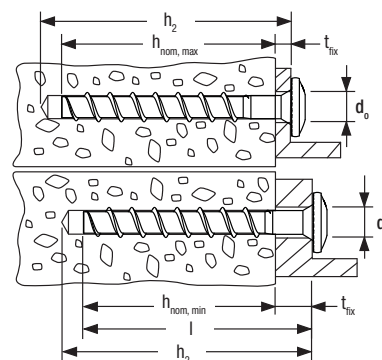

Item	Art.-No.	Approval ETA	Drill hole diameter	Min. drill hole depth for through fixings	Screw length	Head-Ø	Screw-in depth	Usable length	Drive	Sales unit
			d_0 [mm]	h_2 [mm]	l_s [mm]	d_K [mm]	$h_{nom,min} - h_{nom,max}$ [mm]	$t_{fix,min} - t_{fix,max}$ [mm]		
FBS II 6 x 30/5 P	546377	■	6	40	30	14.4	25	Screw length - h_{nom}	T30	100
FBS II 6 x 40/5 P	546378	■	6	50	40	14.4	25 - 35	Screw length - h_{nom}	T30	100
FBS II 6 x 40/5 LP	546379	■	6	50	40	17.5	25 - 35	Screw length - h_{nom}	T30	100
FBS II 6 x 60/5 P	546380	■	6	70	60	14.4	25 - 55	Screw length - h_{nom}	T30	100
FBS II 6 x 80/25 P	546381	■	6	90	80	14.4	25 - 55	Screw length - h_{nom}	T30	100
FBS II 6 x 30/5 SK	546382	■	6	40	30	13.5	25	Screw length - h_{nom}	T30	100
FBS II 6 x 40/5 SK	546383	■	6	50	40	13.5	25 - 35	Screw length - h_{nom}	T30	100
FBS II 6 x 60/5 SK	546384	■	6	70	60	13.5	25 - 55	Screw length - h_{nom}	T30	100
FBS II 6 x 80/25 SK	546385	■	6	90	80	13.5	25 - 55	Screw length - h_{nom}	T30	100
FBS II 6 x 100/45 SK	546386	■	6	110	100	13.5	25 - 55	Screw length - h_{nom}	T30	100
FBS II 6 x 120/65 SK	546387	■	6	130	120	13.5	25 - 55	Screw length - h_{nom}	T30	100
FBS II 6 x 140/85 SK	546388	■	6	150	140	13.5	25 - 55	Screw length - h_{nom}	T30	100
FBS II 6 x 160/105 SK	546389	■	6	170	160	13.5	25 - 55	Screw length - h_{nom}	T30	100
FBS II 6 x 40/5 US	546390	■	6	50	40	17	25 - 35	Screw length - h_{nom}	SW 10	100
FBS II 6 x 60/5 US	546391	■	6	70	60	17	25 - 55	Screw length - h_{nom}	SW 10	100
FBS II 6 x 80/25 US	546392	■	6	90	80	17	25 - 55	Screw length - h_{nom}	SW 10	100
FBS II 6 x 100/45 US	546393	■	6	110	100	17	25 - 55	Screw length - h_{nom}	SW 10	100
FBS II 6 x 120/65 US	546394	■	6	130	120	17	25 - 55	Screw length - h_{nom}	SW 10	100

TECHNICAL DATA



ULTRACUT FBS II M8/M10
- outside diameter



ULTRACUT FBS II M8/M10 I
- internal thread M8/M10

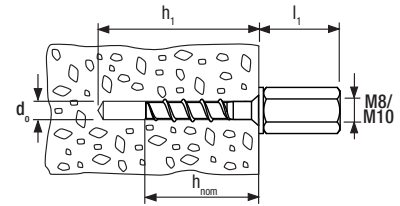

4 High performance steel anchors

Item	Art.-No.	Approval ETA	Drill hole diameter d_0 [mm]	Min. drill hole depth for pre-positioned installation h_1 [mm]	Projection length l_1 [mm]	Screw-in depth h_{nom} [mm]	Drive	Sales unit [pcs]
FBS II 6 x 25 M8/19	546395	■	6	35	4	25	SW 10	100
FBS II 6 x 35 M8/19	546396	■	6	65	4	35	SW 10	100
FBS II 6 x 55 M8/19	546397	■	6	45	37	55	SW 10	100
FBS II 6 x 35 M10/21	546398	■	6	45	4	35	SW 13	100
FBS II 6 x 55 M10/21	546399	■	6	65	5	55	SW 13	100
FBS II 6 x 35 M8/M10 I	546400	■	6	45	5	35	SW 13	100
FBS II 6 x 55 M8/M10 I	546401	■	6	65	37	55	SW 13	100

LOADS

Concrete screw ULTRACUT FBS II 6

zinc plated steel

Permissible loads of a single anchor in cracked normal concrete (concrete tension zone) of strength class C20/25 (~B25) ^{1) 2) 3) 10)}											Minimum spacings while reducing the load	
Type	Material fixing element	Minimum member thickness h_{min} [mm]	Screw-in depth h_{nom} [mm]	Maximum installation torque T_{max} [Nm]	Installation torque $T_{imp,max}^{6)}$ [Nm]	Permissible tensile load $N_{perm}^{7)}$ [kN]	Permissible shear load $V_{perm}^{7)}$ [kN]	Required edge distance (with one edge) for		Required spacing for Max. Load s_{scr} [mm]	Min. spacing $s_{min}^{8)}$ [mm]	Min. edge distance $c_{min}^{8)}$ [mm]
								Max. tension load c [mm]	Max. shear load c [mm]			
FBS II 6x40⁵⁾	gvz	80	40	10	450	1,2	4,3	35	110	100	35	35
FBS II 6x45⁵⁾	gvz	90	45	10	450	1,7	4,3	35	105	110	35	35
FBS II 6x50⁵⁾	gvz	90	50	10	450	1,9	4,3	35	100	120	35	35
FBS II 6x55⁵⁾	gvz	100	55	10	450	2,4	6,3	35	145	135	35	35

For the design the complete assessment ETA-15/0352 has to be considered.⁹⁾

¹⁾ The partial safety factors for material resistance as regulated in the ETA-15/0352 as well as a partial safety factor for load actions of $\gamma_L = 1,4$ are considered. As an single anchor counts e.g. an anchor with a spacing $s \geq 3 \cdot h_{ef}$ and an edge distance $c \geq 1,5 \cdot h_{ef}$. Accurate data see ETA-15/0352.

²⁾ For higher concrete strength classes up to C50/60 higher permissible loads may be possible.

³⁾ Drill method hammer drilling resp. hollow drilling. For further allowable drill methods see ETA-15/0352.

⁴⁾ The anchorage depths smaller than 40 mm are only allowed for single anchors as part of a multiple fixing of non-structural systems.

⁵⁾ Diamond drilling not permitted.

⁶⁾ Maximum allowable torque for installation with any tangential impact screw driver.

⁷⁾ For combinations of tensile loads and shear loads or for shear loads with lever arm (bending moments) as well as reduced edge distances or spacings (anchor groups) we recommend to use our anchor design software C-FIX.

⁸⁾ Minimum possible axial spacings resp. edge distance while reducing the permissible load.

⁹⁾ The given loads refer to the European Technical Assessment ETA-15/0352, issue date 30/10/2018. Design of the loads according ETAG 001, Annex C, Method A (for static resp. quasi-static loads).

¹⁰⁾ A reinforcement in the concrete to prevent splitting is required. The width of the cracks has to be limited under consideration of the splitting forces at $w_k \sim 0,3$ mm.

LOADS

Concrete screw ULTRACUT FBS II 6

zinc plated steel

Permissible loads of a single anchor in non-cracked normal concrete (concrete compression zone) of strength class C20/25 (~B25) ¹⁾²⁾³⁾											Minimum spacings while reducing the load	
Type	Material fixing element	Minimum member thickness	Screw-in depth	Maximum installation torque	Installation torque	Permissible tensile load	Permissible shear load	Required edge distance (with one edge) for		Required spacing for	Min. spacing	Min. edge distance
								Max. tension load	Max. shear load			
		h_{min} [mm]	h_{nom} [mm]	T_{max} [Nm]	T_{imp,max_6} [Nm]	$N_{perm}^{7)}$ [kN]	$V_{perm}^{7)}$ [kN]	c [mm]	c [mm]	Max. Load s_{cr} [mm]	$s_{min}^{8)}$ [mm]	$c_{min}^{8)}$ [mm]
FBS II 6x40 ⁵⁾	gvz	80	40	10	450	3,8	4,3	40	75	100	35	35
FBS II 6x45 ⁵⁾	gvz	90	45	10	450	4,8	4,3	50	70	110	35	35
FBS II 6x50 ⁵⁾	gvz	90	50	10	450	5,7	4,3	55	70	120	35	35
FBS II 6x55 ⁵⁾	gvz	100	55	10	450	6,4	6,3	60	100	135	35	35

For the design the complete assessment ETA-15/0352 has to be considered.⁹⁾

- ¹⁾ The partial safety factors for material resistance as regulated in the ETA-15/0352 as well as a partial safety factor for load actions of $\gamma_L = 1,4$ are considered. As an single anchor counts e.g. an anchor with a spacing $s \geq 3 \cdot h_{ef}$ and an edge distance $c \geq 1,5 \cdot h_{ef}$. Accurate data see ETA-15/0352.
- ²⁾ For higher concrete strength classes up to C50/60 higher permissible loads may be possible.
- ³⁾ Drill method hammer drilling resp. hollow drilling. For further allowable drill methods see ETA-15/0352.
- ⁴⁾ The anchorage depths smaller than 40 mm are only allowed for single anchors as part of a multiple fixing of non-structural systems.
- ⁵⁾ Diamond drilling not permitted.
- ⁶⁾ Maximum allowable torque for installation with any tangential impact screw driver.
- ⁷⁾ For combinations of tensile loads and shear loads or for shear loads with lever arm (bending moments) as well as reduced edge distances or spacings (anchor groups) we recommend to use our anchor design software C-FIX.
- ⁸⁾ Minimum possible axial spacings resp. edge distance while reducing the permissible load.
- ⁹⁾ The given loads refer to the European Technical Assessment ETA-15/0352, issue date 30/10/2018. Design of the loads according ETAG 001, Annex C, Method A (for static resp. quasi-static loads).

LOADS

Concrete screw ULTRACUT FBS II 6 zinc plated

Highest permissible loads for a single anchor¹⁾ for multiple use for non-structural applications in cracked concrete C20/25 to C50/60.

Type	Material fixing element	Screw-in depth	Min. member thickness		Installation torque	Permissible tensile load	Permissible shear load	Required edge distance (with one edge) for		Required spacing for	Min. spacing	Min. edge distance
			h_{nom} [mm]	h_{min} [mm]				Max. tension load c [mm]	Max. shear load c [mm]			
		h_{nom} [mm]	h_{min} [mm]	$T_{inst,max}$ [Nm]	$N_{perm}^{3)}$ [kN]	$V_{perm}^{3)}$ [kN]	c [mm]	c [mm]	s [mm]	$s_{min}^{2)}$ [mm]	$c_{min}^{2)}$ [mm]	
FBS II 6	gvz	25	80	≤ 5	0.7	1.8	35	50	60	35	35	
FBS II 6	gvz	30	80	≤ 5	1.2	2.3	35	55	70	35	35	
FBS II 6	gvz	35	80	≤ 5	1.7	4.3	35	100	100	35	35	
FBS II 6	gvz	40	80	≤ 10	2.4	4.3	35	105	110	35	35	
FBS II 6	gvz	45	90	≤ 10	2.9	4.3	40	110	115	35	35	
FBS II 6	gvz	50	90	≤ 10	3.6	4.3	50	115	120	35	35	
FBS II 6	gvz	55	100	≤ 10	4.0	6.3	50	145	135	35	35	

For the design the complete assessment ETA-18/0242, issued 30.10.2018 has to be considered.

- ¹⁾ The partial safety factors for material resistance as regulated in the approval as well as a partial safety factor for load actions of $\gamma_L = 1,4$ are considered. As an single anchor counts e.g. an anchor with a spacing $s \geq 3 \cdot h_{ef}$ and an edge distance $c \geq 1,5 \cdot h_{ef}$. Accurate data see assessment.
- ²⁾ Minimum possible axial spacings resp. edge distance while reducing the permissible load.
- ³⁾ For combinations of tensile loads, shear loads, bending moments as well as reduced edge distances or spacings (anchor groups) see assessment.

LOADS

Concrete screw ULTRACUT FBS II 6 zinc plated

Highest permissible loads for a single anchor¹⁾ for multiple use for non-structural applications in non-cracked concrete C20/25 to C50/60.

Type	Material fixing element	Screw-in depth h_{nom} [mm]	Min. member thickness h_{min} [mm]	Installation torque $T_{inst, max}$ [Nm]	Permissible tensile load $N_{perm}^{3)}$ [kN]	Permissible shear load $V_{perm}^{3)}$ [kN]	Required edge distance (with one edge) for		Required spacing for s [mm]	Min. spacing $s_{min}^{2)}$ [mm]	Min. edge distance $c_{min}^{2)}$ [mm]
							Max. tension load c [mm]	Max. shear load c [mm]			
FBS II 6	gvz	25	80	≤ 5	1.4	2.3	35	45	60	35	35
FBS II 6	gvz	30	80	≤ 5	2.4	2.3	35	45	70	35	35
FBS II 6	gvz	35	80	≤ 5	3.1	4.3	40	70	100	35	35
FBS II 6	gvz	40	80	≤ 10	3.8	4.3	55	70	110	35	35
FBS II 6	gvz	45	90	≤ 10	4.8	4.3	65	75	115	35	35
FBS II 6	gvz	50	90	≤ 10	5.7	4.3	75	75	120	35	35
FBS II 6	gvz	55	100	≤ 10	6.4	6.3	80	100	135	35	35

For the design the complete assessment ETA-18/0242, issued 30.10.2018 has to be considered.

¹⁾ The partial safety factors for material resistance as regulated in the approval as well as a partial safety factor for load actions of $\gamma_L = 1.4$ are considered. As an single anchor counts e.g. an anchor with a spacing $s \geq 3 \times h_{ef}$ and an edge distance $c \geq 1.5 \times h_{ef}$. Accurate data see assessment.

²⁾ Minimum possible axial spacings resp. edge distance while reducing the permissible load.

³⁾ For combinations of tensile loads, shear loads, bending moments as well as reduced edge distances or spacings (anchor groups) see assessment.

LOADS

Concrete screw ULTRACUT FBS II 6 zinc plated

Highest permissible loads¹⁾ for a single anchor for multiple use for non-structural applications in pre-stressed hollow core slabs⁴⁾

Type	FBS II 6							
	Nominal embedment depth h_{nom}	25	30	35	40	45	50	55
Permissible load in the respective bottom flange thickness $F_{rec}^{3)}$								
≥ 25 mm	[kN]	0,23	0,47	0,47	0,47	0,47	0,47	0,47
≥ 30 mm	[kN]	1,64	1,64	1,64	1,64	1,64	1,64	1,64
≥ 35 mm	[kN]	1,64	1,88	2,11	2,35	2,58	2,82	3,05
≥ 40 mm	[kN]	1,64	2,35	2,58	2,82	3,29	3,52	3,76
≥ 50 mm	[kN]	1,64	2,58	3,29	3,76	4,46	5,16	5,63
Installation torque	$T_{inst, max}$ [Nm]	5	5	10	10	10	10	10
Min. spacing	$s1, s2^{2)}$ [mm]	100	100	100	100	100	100	100
Min. edge distance	$c1, c2^{2)}$ [mm]	100	100	100	100	100	100	100

For the design the complete assessment ETA-18/0242, issued 30.10.2018 has to be considered.

¹⁾ The required partial safety factors for material resistance as well as a partial safety factor for load actions of $\gamma_L = 1.4$ are considered.

²⁾ Minimum possible axial spacings resp. edge distance. For further measures see assessment.

³⁾ Valid for tensile load, shear load and oblique load under any angle.

⁴⁾ Concrete strength class C30/37 up to C50/60.

The internally threaded anchor with rim for simple hammerset installation



VERSIONS

- Zinc-plated steel
- Stainless steel

BUILDING MATERIALS

Approved for:

- Concrete C20/25 to C50/60, cracked, for the multiple fixings of non-load-bearing systems
- Concrete C20/25 to C50/60, non-cracked

Also suitable for:

- Concrete C12/15
- Natural stone with dense structure

CERTIFICATES

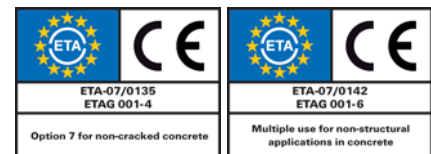

ADVANTAGES

- The embossed rim prevents the anchor sleeve from slipping, thus ensuring a trouble-free hammerset installation.
- The metric internal thread means that it is possible to use standard screws or threaded rods for the ideal adaptation to suit the intended use.
- The EMS machine setting tool allows for effortless installation, particularly in the case of series installations.
- The embossing that is applied when expanding with the EHS Plus setting tool offers a simple control of the anchoring and provides increased safety.
- Fixing point at h_{ef} 25 mm prevents anchor of falling out of the drill hole before being expanded.
- The black fixing point prevents the anchor from falling out of the drill hole during overhead installation.

APPLICATIONS

- Pipelines and ventilation ducts
- Sprinkler systems
- Cable conduits and wires
- Gratings
- Steel constructions
- Machines
- Consoles
- Shuttering props
- Diamond or core drilling devices (EA II M12 D)

FUNCTIONING

- The EA II is suitable for pre-positioned installation.
- Position the hammerset anchor in the drill hole and drive in flush to the surface of the anchor base using the hammer.
- The sleeve is then expanded by driving in the internal bolt with the EHS Plus setting tool (alternative: EMS machine setting tool), and expanded against the drill hole wall.
- The setting tools must sit on the rim of the anchor to ensure correct expansion.
- Use the special EA II M12 x 50 D / EA M 12 x 50 N D with thicker sleeve for fixing diamond and core drilling devices.

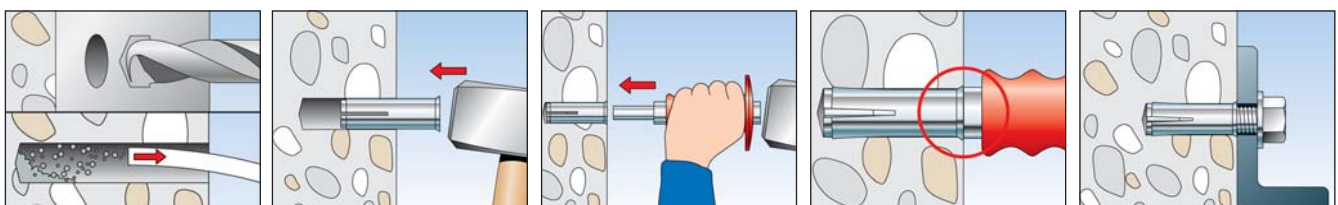

TECHNICAL DATA



Hammerset anchor **EA II**, with reduced anchorage depth h_{ef} 25 mm.



Hammerset anchor **EA II**. Not suitable for diamond drilling appliances and diamond saws.

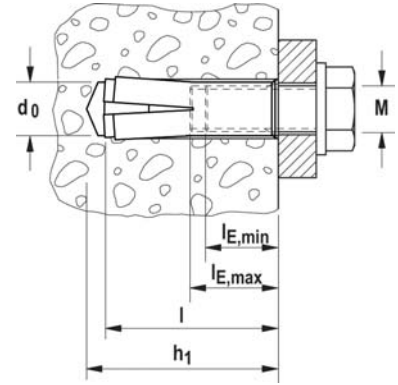

High performance steel anchors 4

	Zinc-plated steel	Stainless steel	Approval	Drill hole diameter	Min. drill hole depth for pre-positioned installation	Anchor length	Internal thread	Min. bolt penetration	Max. bolt penetration	Sales unit
	Art.-No.	Art.-No.	ETA	d_0 [mm]	h_1 [mm]	l [mm]	M	$l_{E,min}$ [mm]	$l_{E,max}$ [mm]	[pcs]
Item	gvz	A4								
EA II M 6 x 25	532230	—	■	8	27	25	M 6	6	14	100
EA II M 6 x 30	048264	048410	■	8	32	30	M 6	6	14	100
EA II M 8 x 25	532231	—	■	10	27	25	M 8	8	14	100
EA II M 8 x 30	048284	048411	■	10	33	30	M 8	8	14	100
EA II M 8 x 40	048323	048412	■	10	43	40	M 8	8	14	50
EA II M 10 x 25	532232	—	■	12	27	25	M 10	10	14	50
EA II M 10 x 30	048332	—	■	12	33	30	M 10	10	14	50
EA II M 10 x 40	048339	048414	■	12	43	40	M 10	10	17	50
EA II M 12 x 25	532233	—	■	15	27	25	M 12	12	14	25
EA II M 12 x 50	048406	048415	■	15	54	50	M 12	12	22	25
EA II M 16 x 65	048408	048416	■	20	70	65	M 16	16	28	20
EA II M 20 x 80	048409	048417	■	25	85	80	M 20	20	34	10

Associated setting tool for manual installation (EHS Plus), for installation with hammer drill (EMS)

TECHNICAL DATA



Hammerset anchor **EA II M 12 x 50 D**. Suitable for diamond drilling appliances and diamond saws.



Hammerset anchor **EA M 12 x 50 N D**. Suitable for diamond drilling machines and diamond saws.

	Zinc-plated steel	Approval	Drill hole diameter	Min. drill hole depth	Anchor length	Internal thread	Min. bolt penetration	Max. bolt penetration	Sales unit
	Art.-No.	ETA	d_0 [mm]	h_1 [mm]	l [mm]	M	$l_{E,min}$ [mm]	$l_{E,max}$ [mm]	[pcs]
Item	gvz								
EA II M 12 x 50 D	048407	■	16	54	50	M 12	12	22	25
EA M 12 x 50 N D	500872	—	16	54	50	M 12	12	22	50

Associated setting tool for manual installation (EHS Plus), for installation with hammer drill (EMS)

ACCESSORIES



Stop drill **EBB**

Item	Art.-No.	Tool holder	Drill hole diameter	Drill hole depth	Match	Sales unit
			[mm]	[mm]		[pcs]
EBB 8 x 25	532607	SDS plus	8	27	EA II M 6 x 25	1
EBB 10 x 25	532608	SDS plus	10	27	EA II M 8 x 25	1
EBB 12 x 25	532609	SDS plus	12	27	EA II M 10 x 25	1
EBB 15 x 25	532610	SDS plus	15	27	EA II M 12 x 25	1

ACCESSORIES



Machine setting tool **EMS**

Item	Art.-No.	Tool holder	Match	Sales unit [pcs]
EMS M 6 x 25/30	048065	SDS plus	EA II M 6 x 25, EA II M 6 x 30	1
EMS M 8 x 25/30	048066	SDS plus	EA II M 8 x 25, EA II M 8 x 30	1
EMS M 8 x 40	048067	SDS plus	EA II M 8 x 40	1
EMS M 10 x 25/30	048068 1)	SDS plus	EA II M 10 x 25, EA II M 10 x 30	1
EMS M 10 x 40	048070	SDS plus	EA II M 10 x 40	1
EMS M 12 x 50	048071	SDS plus	EA II M 12 x 50 D, EA II M 12 x 50, EA M 12 x 50 N D	1
EMS M 16 x 65	048072 1)	SDS max	EA II M 16 x 65	1
EMS M 20 x 80	048073 1)	SDS max	EA II M 20 x 80	1

1) Delivery time on request.

ACCESSORIES



Setting tool **EHS Plus** with hand impact protection for your safety and embossing tool.



Setting tool **EA-ST**

Item	Art.-No.	Match	Sales unit [pcs]
EHS M 6 x 25/30 Plus	044630	EA II M 6 x 25, EA II M 6 x 30	1
EHS M 8 x 25/30 Plus	044631	EA II M 8 x 25, EA II M 8 x 30	1
EHS M 8 x 40 Plus	044632	EA II M 8 x 40	1
EHS M 10 x 25/30 Plus	048487	EA II M 10 x 25, EA II M 10 x 30	1
EHS M 12 x 25 Plus	532568	EA II M 12 x 25	1
EHS M 10 x 40 Plus	044633	EA II M 10 x 40	1
EHS M 12 x 50 Plus	044634	EA II M 12 x 50, EA II M 12 x 50 D	1
EHS M 16 x 65 Plus	044635	EA II M 16 x 65	1
EHS M 20 x 80 Plus	044636	EA II M 20 x 80	1
EA-ST 12	504585	EA M 12 x 50 N D	1

LOADS

Hammerset anchor EA II

zinc plated steel / stainless steel

Permissible loads of a single anchor in non-cracked normal concrete (concrete compression zone) of strength class C20/25 (~B25) ^{1) 2) 3)}										Minimum spacings while reducing the load	
Type	Screw material resp. screw surface	Minimum member thickness	Effective anchorage depth	Maximum installation torque	Permissible tensile load	Permissible shear load	Required edge distance (with one edge) for		Required spacing for	Min. spacing	Min. edge distance
							Max. tension load c	Max. shear load c			
		h _{min} [mm]	h _{ef} [mm]	T _{max} [Nm]	N _{perm} ⁴⁾ [kN]	V _{perm} ⁴⁾ [kN]	[mm]	[mm]	[mm]	[mm]	[mm]
EA II M6 x 30 ⁸⁾	5.8	80	30	4	3,9	2,9	150	150	90	70	150
	8.8										
	A4-70										
EA II M8 x 30 ⁸⁾	5.8	80	30	8	3,9	4,9	150	150	90	110	150
	8.8										
	A4-70										
EA II M8 x 40	5.8	80	40	8	6,1	4,9	150	150	120	200	150
	8.8										
	A4-70										
EA II M10 x 40	5.8	100	40	15	6,1	6,2	180	180	120	150	180
	8.8										
	A4-70										
EA II M12	5.8	100	50	35	8,5	11,3	200	200	150	200	200
	8.8										
	A4-70										
EA II M16	5.8	160	65	60	12,6	18,3	240	240	195	180	240
	8.8										
	A4-70										
EA II M20	5.8	200	80	120	17,2	29,1	280	285	240	190	280
	8.8										
	A4-70										
						33,7		340			

For the design the complete assessment ETA-07/0135 has to be considered. ⁷⁾

¹⁾ The partial safety factors for material resistance as regulated in the ETA-07/0135 as well as a partial safety factor for load actions of $\gamma_L = 1,4$ are considered. As an single anchor counts e.g. an anchor with a spacing $s \geq 3 \cdot h_{ef}$ and an edge distance $c \geq 1,5 \cdot h_{ef}$. Accurate data see ETA-07/0135.

²⁾ For higher concrete strength classes up to C50/60 higher permissible loads may be possible.

³⁾ Drill method hammer drilling.

⁴⁾ For combinations of tensile loads, shear loads, bending moments as well as reduced edge distances or spacings (anchor groups) see ETA-07/0135.

⁵⁾ Minimum possible axial spacings resp. edge distance while reducing the permissible load.

⁶⁾ Minimum possible spacing resp. edge distance while reducing the permissible load for the required minimum member thickness. The combination of minimum edge distance and minimum spacing is not possible. One of both values has to be increased acc. ETA-07/0135.

⁷⁾ The given loads refer to the European Technical Assessment ETA-07/0135, issue date 09/12/2016. Design of the loads according ETAG 001, Annex C, Method A (for static resp. quasi-static loads).

⁸⁾ Only approved for statically indeterminate systems.

LOADS

Hammerset anchor EA II galvanised / corrosion resistant steel A4

Highest permissible loads for a single anchor¹⁾⁶⁾ for multiple use for non-structural applications in cracked and non-cracked concrete C20/25 up to C50/60⁵⁾.

Type	Effective anchorage depth	Min. member thickness	Maximum torque moment	Permissible load	Required spacing for	Min. spacing	Min. edge distance
	h_{ef} [mm]	$h_{min}^{4)}$ [mm]	$T_{inst,max}$ [Nm]	$F_{perm}^{3)}$ [kN]	Max. Load s [mm]	$s_{min}^{2)}$ [mm]	$c_{min}^{2)}$ [mm]
EA II M6 x 25	25	80	4,0	1,0	75	30	60
EA II M6 x 30	30	80	4,0	1,2	90	65	115
EA II M8 x 25	25	80	8,0	1,4	75	50	100
EA II M8 x 30	30	80	8,0	2,0	90	70	115
EA II M8 x 40	40	80	8,0	2,0	120	70	115
EA II M10 x 25	25	80	15,0	1,9	75	60	100
EA II M10 x 30	30	80	15,0	2,0	90	85	140
EA II M10 x 40	40	80	15,0	3,0	200	95	150
EA II M12 x 25	25	80	35,0	1,9	75	100	110
EA II M12 x 50	50	100	35,0	4,3	300	145	200

For the design the complete approval ETA-07/0142 has to be considered.

¹⁾ The required partial safety factors for material resistance as well as a partial safety factor for load actions of $\gamma_L = 1,4$ are considered.

²⁾ Minimum possible axial spacings resp. edge distances while increasing the member thickness. The combination of minimum axial spacing and minimum edge distance with the minimum member thickness is not possible. Exact data see approval.

³⁾ Valid for tensile load, shear load and oblique load under any angle. For combinations of tensile loads, shear loads as well as bending moments see approval.

⁴⁾ Minimum possible member thickness while increasing the axial spacings and edge distances. The combination of minimum axial spacing and minimum edge distance with the minimum member thickness is not possible. Exact data see approval.

⁵⁾ Further data for concrete C12/15 see approval.

⁶⁾ Screw property class 4.6 and A4-50.

LOADS

Hammerset anchor EA II (screw property class 4.6 and A4-50)

Highest permissible loads¹⁾ for a single anchor for multiple use for non-structural applications in pre-stressed hollow core slabs⁴⁾

Type	Bottom flange thickness	Effective anchorage depth	Maximum torque moment	Permissible load	Min. spacing	Min. edge distance
	[mm]	h_{ef} [mm]	$T_{inst,max}$ [Nm]	$F_{perm}^{3)}$ [kN]	$s_{min}^{2)}$ [mm]	$c_{min}^{2)}$ [mm]
EA II M6 x 25	$\geq 35^{5)}$	25	4,0	1,0	200	150
EA II M8 x 25			8,0	1,4		
EA II M10 x 25			15,0	1,9		
EA II M12 x 25			35,0	1,9		

For the design the complete approval ETA-07/0142 has to be considered.

¹⁾ The required partial safety factors for material resistance as well as a partial safety factor for load actions of $\gamma_L = 1,4$ are considered.

²⁾ Minimum possible axial spacings resp. edge distance. For further measures see approval.

³⁾ Valid for tensile load, shear load and oblique load under any angle. For combinations of tensile loads, shear loads as well as bending moments see approval.

⁴⁾ Concrete strength class C30/37 up to C50/60.

⁵⁾ The anchor may be used in a flange thickness $d_b = 30$ mm with the same characteristic resistance, but the drill hole must not cut a cavity.

The cost-efficient hammerset anchor for an easy installation



Pipelines



Height adjustable pipe installation

VERSIONS

- Zinc-plated steel

BUILDING MATERIALS

- Concrete C12/15 to C50/60, non-cracked

ADVANTAGES

- The hammerset anchor with internal thread is suitable for pre-positioned installation.
- The EA-N fits for all standard screws with metric/inch - thread.
- The available internal thread diameter from 6 mm to 20 mm provides flexibility in the application.

APPLICATIONS

- Pipeline routes
- Cable trays
- Consoles

FUNCTIONING

- Put the hammerset anchor in the drill hole and get it flush to the surface by hammering in.
- With the hammerset tool EA-ST the capsule will spread due to hammering in the internal bolt and tensed up against the drill hole wall.
- The hammerset tools must be set up on the edge of the anchor for a correct expansion.

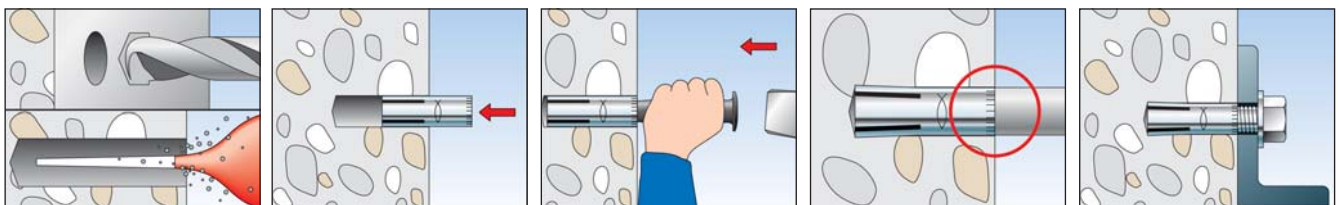

TECHNICAL DATA



Hammerset anchor **EA-N Metric**

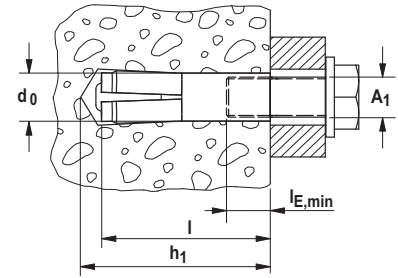

Item	Art.-No.	Drill hole diameter d_0 [mm]	Min. drill hole depth for pre-positioned installation h_1 [mm]	Anchor length l [mm]	Internal thread A1	Min. bolt penetration $l_{E,min}$ [mm]	Sales unit [pcs]
EA M 6 x 25 N gvz	090159	8	25	25	M 6	6	100
EA M 8 x 30 N gvz	090160	10	30	30	M 8	8	100
EA M 10x40 N gvz	090161	12	40	40	M 10	10	50
EA M 12 x 50 N gvz	090162	15	50	50	M 12	12	50
EA M 16 x 65 N gvz	090163	20	65	65	M 16	16	25
EA M 20 x 80 N gvz	090164	25	80	80	M 20	20	25
EA M 12 x 50 N D gvz	500872	16	50	50	M 12	12	50



Hammerset anchor **EA-N Inch-metric**

Item	Art.-No.	Drill hole diameter d_0 [mm]	Min. drill hole depth for pre-positioned installation h_1 [mm]	Anchor length l [mm]	Internal thread A1	Min. bolt penetration $l_{E,min}$ [mm]	Sales unit [pcs]
EA IM 1/4 x 25 N gvz	048103	8	25	25	1/4"	6	100
EA IM 5/16 x 30 N gvz	048104	10	30	30	5/16"	8	100
EA IM 3/8 x 40 N gvz	048105	12	40	40	3/8"	10	50
EA IM 1/2 x 50 N gvz	048106	16	50	50	1/2"	12	50
EA IM 5/8 x 65 N gvz	048107	20	65	65	5/8"	16	25
EA IM 3/4 x 80 N gvz	048108	25	80	70	3/4"	20	25



Hammerset anchor **EA-N Inch**

Item	Art.-No.	Drill diameter d_0 [Inch]	Min. drill hole depth for pre-positioned installation h_1 [Inch]	Total length l [Inch]	Internal thread A1 [Inch]	Min. bolt penetration $l_{E,min}$ [Inch]	Sales unit [pcs]
EA I 1/4 x 1" N gvz	049185	3/8	1	1	1/4	1/4	100
EA I 5/16 x 1 3/16" N gvz	049194	3/8	1 1/4	1 1/4	5/16	5/16	100
EA I 3/8 x 1 9/16" N gvz	049195	1/2	1 9/16	1 5/8	3/8	3/8	50
EA I 1/2 x 2" N gvz	049197	5/8	2	2	1/2	1/2	50
EA I 5/8 x 2 1/2" N gvz	049198	3/4	2 3/8	2 1/2	5/8	5/8	20

ACCESSORIES



Item		Match	Sales unit [pcs]
EA-ST 6	504573	EA N M6	1
EA-ST 8	504576	EA N M8	1
EA-ST 10	504584	EA N M10	1
EA-ST 12	504585	EA N M12	1
EA-ST 16	504586	EA N M16	1
EA-ST 20	504587	EA N M20	1

LOADS

Hammerset anchor EA-N

zinc plated steel

Recommended loads of a single anchor in non-cracked normal concrete (concrete compression zone) of strength class C20/25 ¹⁾						Minimum spacings while reducing the load	
Type	Screw material	Min. member thickness h_{min} [mm]	Effective anchorage depth h_{ef} [mm]	Maximum torque moment T_{max} [Nm]	Recommended Tensile load N_{rec} [kN]	Min. spacing $s_{min}^{2)}$ [mm]	Min. edge distance $c_{min}^{2)}$ [mm]
EA M6x25 N³⁾	≥ 4.6	100	25	4	2,0	65	115
EA M8x30 N³⁾	≥ 4.6	100	30	8	2,5	95	140
EA M10x40 N	≥ 4.6	100	40	15	4,5	150	180
EA M12x50 N	≥ 4.6	120	50	35	6,0	145	200
EA M12x50 N D	≥ 4.6	120	50	35	6,0	145	200
EA M16x65 N	≥ 4.6	160	65	60	11,5	180	240
EA M20x80 N	≥ 4.6	200	80	120	16,0	190	280

¹⁾ Required safety factors are considered.

²⁾ Minimum possible axial spacings resp. edge distance while reducing the recommended load.

³⁾ Only suitable for statically indeterminate systems.

LOADS

Hammerset anchor EA-N Inch Metric

zinc plated steel

Recommended loads of a single anchor in non-cracked normal concrete (concrete compression zone) of strength class C20/25 ¹⁾						Minimum spacings while reducing the load	
Type	Screw material	Min. member thickness h_{min} [mm]	Effective anchorage depth h_{ef} [mm]	Maximum torque moment T_{max} [Nm]	Recommended Tensile load N_{rec} [kN]	Min. spacing $s_{min}^{2)}$ [mm]	Min. edge distance $c_{min}^{2)}$ [mm]
EA IM 1/4x25 N³⁾	≥ 4.6	100	25	4	3,0	65	115
EA IM 5/16x30 N³⁾	≥ 4.6	100	30	8	4,0	95	140
EA IM 3/8x40 N	≥ 4.6	100	40	15	6,0	150	180
EA IM 1/2x50 N	≥ 4.6	120	50	35	7,0	145	200
EA IM 5/8x65 N	≥ 4.6	160	65	60	12,0	180	240
EA IM 3/4x80 N	≥ 4.6	200	80	120	18,0	190	280

¹⁾ Required safety factors are considered.

²⁾ Minimum possible axial spacings resp. edge distance while reducing the recommended load.

³⁾ Only suitable for statically indeterminate systems.

LOADS

Hammerset anchor EA-N Inch

zinc plated steel

Recommended loads of a single anchor in non-cracked normal concrete (concrete compression zone) of strength 3500 psi ¹⁾						Minimum spacings while reducing the load	
Type	Screw material	Min. member thickness h_{min} [in.]	Effective anchorage depth h_{ef} [in.]	Maximum torque moment T_{max} [ft-lb]	Recommended Tensile load N_{rec} [lb]	Min. spacing s_{min} ²⁾ [in.]	Min. edge distance c_{min} ²⁾ [in.]
EA I 1/4x1 N³⁾	≥ ISO 898-1 Klasse 4.6	4	1	3	560	2 9/16	4 1/2
EA I 5/16x1 3/16 N³⁾	≥ ISO 898-1 Klasse 4.6	4	1 3/16	6	900	3 3/4	5 1/2
EA I 3/8x1 9/16 N	≥ ISO 898-1 Klasse 4.6	4	1 9/16	11	1120	5 5/16	7 1/8
EA I 1/2x2 N	≥ ISO 898-1 Klasse 4.6	4 3/4	2	26	1240	5 11/16	7 7/8
EA I 5/8x2 1/2 N	≥ ISO 898-1 Klasse 4.6	6 3/8	2 1/2	44	2020	7 1/8	9 1/2

¹⁾ Required safety factors are considered.

²⁾ Minimum possible axial spacings resp. edge distance while reducing the recommended load.

³⁾ Only suitable for statically indeterminate systems.

The installation-friendly hammer-set anchor for multiple fixings

High performance steel anchors 4

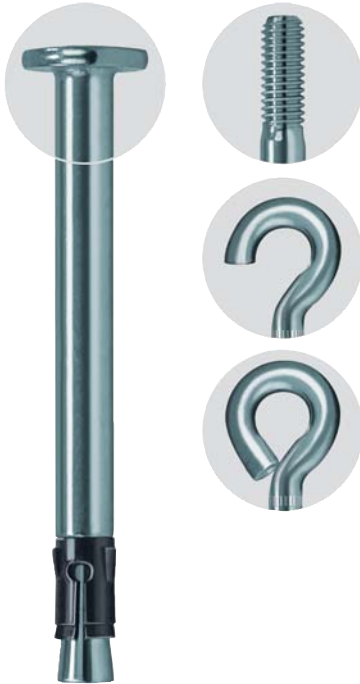

VERSIONS

- Zinc-plated steel
- Stainless steel
- Highly corrosion-resistant steel

BUILDING MATERIALS

Approved for:

- Concrete C12/15 to C50/60, cracked, for multiple fixings of non-structural applications

Also suitable for:

- Solid sand-lime brick
- Natural stone with dense structure
- Prestressed hollow-core concrete slabs

CERTIFICATES

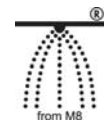

ADVANTAGES

- The special active principle allows for a simple hammer-set installation and, therefore, a short processing time.
- The extremely short anchor depth prevents reinforcement hits, and creates the conditions for a trouble-free installation.
- The optimised expansion clip ensures hold when placing in the drill hole, and prevents it falling out during overhead installations.
- The massive shaft cross-section guarantees a high load-bearing capacity, thus offering an extremely high level of safety.
- A range of head shapes allows for the fixing of wide-ranging fixtures, and for the ideal adaptation to suit the intended use.

APPLICATIONS

- Fire protection plates
- Fire protection boards
- Ventilation systems
- Wire and nonious hangers
- Mounting rails
- Metal clamps
- Substructures made of wood and metal

FUNCTIONING

- The FNA II with nail head is suitable for push-through installation. The FNA II M6 is suitable for pre-positioned and push-through installation. The FNA II OE and H are suitable for pre-positioned installation.
- The installed FNA II nail anchor expands automatically under load. The cone is pulled into the expansion clip and expands it against the drill hole wall.
- Available setting tools:
FNA S-SBO to slip onto the drill,
FNA S-SDS for series installation with a drilling hammer,
FNA S-H for the manual installation of mounting rails.

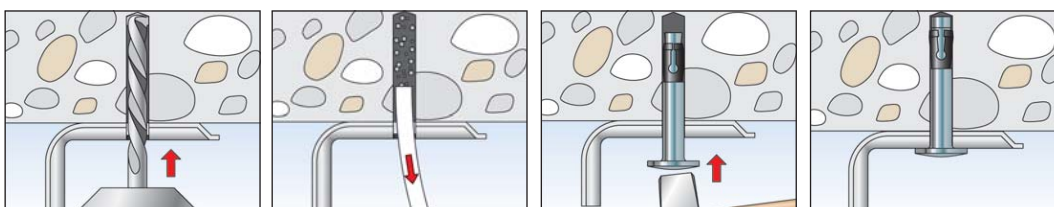

TECHNICAL DATA



Nail anchor **FNA II** with nail head

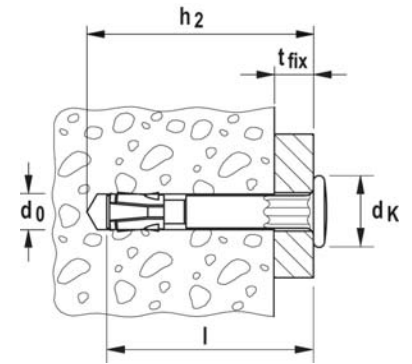

	Zinc-plated steel	Stainless steel	Highly corrosion resistant steel	Approval	Drill hole diameter	Min. drill hole depth for through fixings	Anchor length	Max. fixture thickness	Head-Ø	Sales unit	
	Art.-No.	Art.-No.	Art.-No.	ETA	d ₀ [mm]	h ₂ [mm]	l [mm]	t _{fix} [mm]	d _k [mm]	[pcs]	
Item	gvz	A4	C								
FNA II 6 x 25/5	044121 ¹⁾	—	—	■	6	40	35	5	13.0	100	
FNA II 6 x 30/5	044115 ¹⁾	044122	—	■	6	45	40	5	13.0	100	
FNA II 6 x 30/5	—	—	044124	■	6	45	40	5	13.0	25	
FNA II 6 x 30/30	044116	044123	—	■	6	70	65	30	13.0	50	
FNA II 6 x 30/30	—	—	044125	■	6	70	65	30	13.0	25	
FNA II 6 x 30/50	044117	046024	500569	■	6	90	85	50	13.0	50	
FNA II 6 x 30/75	044118	—	500573 ²⁾	■	6	115	110	75	13.0	50	
FNA II 6 x 30/100	044119	—	500574 ³⁾	■	6	140	135	100	13.0	50	
FNA II 6 x 30/120	044120	—	500575 ³⁾	■	6	160	155	120	13.0	50	

1) with hexagon below the nail head for anti-rotation lock of hole and wire hangers (for example) and centring for optional setting tool FNA-S

2) On request.

3) Delivery time on request.

TECHNICAL DATA



Nail anchor **FNA II M6** with thread and flange nut

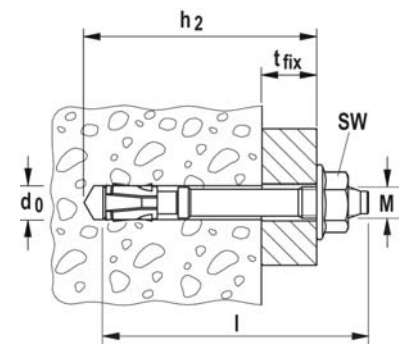

	Zinc-plated steel	Stainless steel	Highly corrosion resistant steel	Approval	Drill hole diameter	Min. drill hole depth for through fixings	Anchor length	Max. fixture thickness	Thread	Width across nut	Sales unit
	Art.-No.	Art.-No.	Art.-No.	ETA	d ₀ [mm]	h ₂ [mm]	l [mm]	t _{fix} [mm]	M	○ SW [mm]	[pcs]
Item	gvz	A4	C								
FNA II 6 x 25 M6/5	044111	—	—	■	6	40	45	5	M 6	10	100
FNA II 6 x 30 M6/5	044109	—	—	■	6	45	50	5	M 6	10	100
FNA II 6 x 30 M6/5	—	044112 ²⁾	—	■	6	45	50	5	M 6	10	50
FNA II 6 x 30 M6/5	—	—	044113 ²⁾	■	6	45	50	5	M 6	10	25
FNA II 6 x 30 M6 x 41	044110 ¹⁾	—	—	■	6	40	41	—	M 6	10	100
FNA II 6 x 30 M6/10	046022	—	—	■	6	45	55	10	M 6	10	100
FNA II 6 x 30 M8/5	044114	—	—	■	6	45	51	5	M 8	13	50

1) without nut; e.g. for fixing of pipe clamps

2) with nut and washer (no flange nut)

TECHNICAL DATA

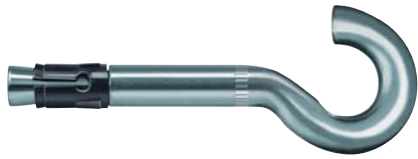

Nail anchor **FNA II-H** with hook



Nail anchor **FNA II-OE** with eye

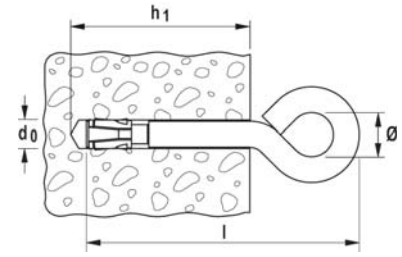

4 High performance steel anchors

	Zinc-plated steel	Approval	Drill hole diameter	Anchor length	Min. drill hole depth	Inner diameter of the hook/eye	Sales unit		
	Art.-No.	ETA	d_0 [mm]	l [mm]	h_1 [mm]	\varnothing [mm]	[pcs]		
Item	gvz								
FNA II 6 x 25 H	044126	—	6	54	35	10	50		
FNA II 6 x 25 OE	044127	■	6	54	35	10	50		

TECHNICAL DATA



Machine setting tool **FNA S-SDS**



Machine setting tool **FNA S-SBO** for mounting on the drill bit (drill-Ø 6mm)



Hand tool **FNA S-H**

Item	Art.-No.			Sales unit [pcs]
FNA S-SDS	061547	for all FNA II with nail head	The ideal setting tool for the serial installation with SDS-plus adapter for driving in FNA II with nail head using a hammer drill.	1
FNA S-SBO	061548	for all FNA II with nail head	For a power saving and fast installation to be placed on the drill.	1
FNA S-H	095990	for FNA II with metric thread M6	E.g. for the fixing of installation of mounting rails. Chuck with outer diameter of 15mm for the installation of FNA II M6 by hand.	1

LOADS

Nail anchor FNA II

zinc plated steel / stainless steel / high corrosion resistant steel

Highest permissible loads ¹⁾ for a single fixing point ⁶⁾ as part of a multiple fixing of non-structural systems ⁴⁾ in concrete C20/25 up to C50/60 ³⁾ .								Minimum spacings while reducing the load	
Type	Material fixing element	Effective anchorage depth h_{ef} [mm]	Minimum member thickness h_{min} [mm]	Maximum torque moment T_{inst} [Nm]	Permissible load $F_{perm}^{2)}$ [kN]	Required edge distance for Max. Load c [mm]	Required spacing for Max. Load s [mm]	Min. spacing $s_{min}^{5)}$ [mm]	Min. edge distance $c_{min}^{5)}$ [mm]
FNA II 6 x 25	gvz	25	80	-	1,4	100 for $s \geq 200$	100 for $c \geq 200$	40	40
FNA II 6 x 30	gvz	30		-	2,4				
	A 4								
	C								
FNA II 6 x 25 M6	gvz	25		4	1,4				
FNA II 6 x 30 M6	gvz	30		4	2,4				
	A 4								
	C								
FNA II 6 x 30 M8	gvz	30	4	2,4					
FNA II 6 x 25 OE	gvz	25	-	0,7					

For the design the complete approval ETA - 06/0175 has to be considered.

¹⁾ The partial safety factors for material resistance as regulated in the approval as well as a partial safety factor for load actions of $\gamma_L = 1,4$ are considered.

²⁾ Valid for tensile load, shear load and oblique load under any angle. For combinations of tensile loads, shear loads, bending moments as well as reduced edge distances or spacings (anchor groups) see approval.

³⁾ For concrete compressive strength C12/15 see approval.

⁴⁾ Multiple use is defined acc ETAG 001 Part 6 with min. 3 fixing points with min. one anchor per fixing point and a permissible load of 1.4 kN or min. 4 fixing points with min. one anchor an a permissible load of 2.1 kN.

⁵⁾ Minimum possible axial spacings resp. edge distances. Smaller permissible loads acc. approval are required.

⁶⁾ A fixing point is defined as a single anchor or a group of 2 or 4 anchor.

The easy-to-assemble fixing solution for removable fire protection panel



Fire protection boards



Fire protection boards

VERSIONS

- Stainless steel
- Highly corrosion-resistant steel

BUILDING MATERIALS

- Concrete C12/15 to C50/60, cracked and non-cracked, for multiple fixings of non-structural applications

CERTIFICATES



ADVANTAGES

- Easy removal of fire protection panel without damage.
- Reusability of removed fire protection panel.
- Secure fixing, particularly when exposed to vibration, wind and pushing/pulling effects.
- Easy-to-assemble solution.
- Low anchoring depth (30 mm).
- Convenient assembly without torque-controlled setting tool.
- Approved system which has proven itself one million times over.
- Large range of anchor lengths possible.

APPLICATIONS

- Fixing of fire protection panel in tunnel construction.
- For fixing of one and more layers of fire protection panel of all manufacturers e.g. Aestuver and Promat.

FUNCTIONING

- Nail anchor with low anchoring depth.
- The washer increases the pull through forces significantly and provides the damage of the panel during dismantling.
- Mounting: Drill, hammer in, and you're done!
- Easy pinching off of nail head thanks to special 2-stage pliers.
- For a fast assembly process, we recommend the fischer compressed air setting device (item no. 093731).

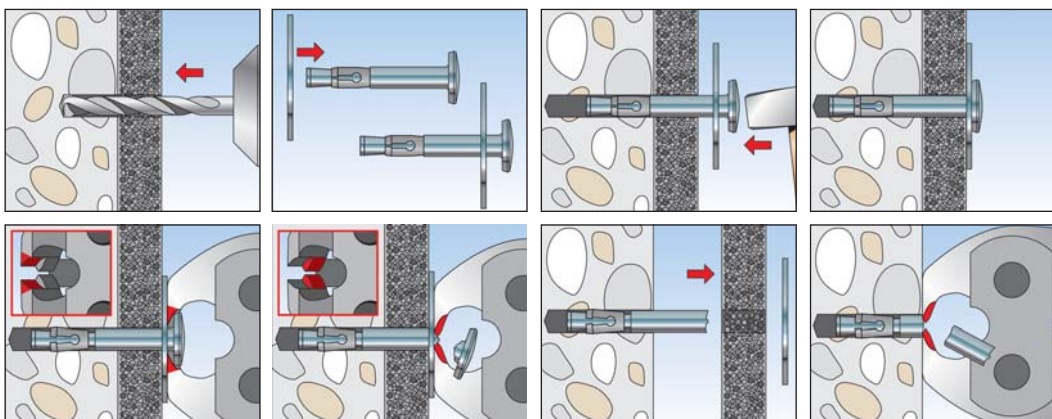

TECHNICAL DATA



Nail anchor **FNA II RB**

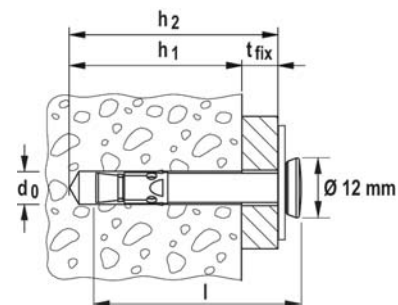

	Stainless steel	Approval	Drill hole diameter	Min. drill hole depth for through fixings	Min. drill hole depth for pre-positioned installation	Anchorage depth	Anchor length	Max. usable length	Sales unit
	Art.-No.	ETA	d_0 [mm]	h_2 [mm]	h_1 [mm]	h_{ef} [mm]	l [mm]	t_{fix} [mm]	[pcs]
Item	A4								
FNA II 6 x30/30 RB	530674 ¹⁾	■	6	66	36	30	68	30	50
FNA II 6 x30/30 RB	530798 ¹⁾	■	6	66	36	30	68	30	200

¹⁾ delivery on request

TECHNICAL DATA



Washer 30/1,5/7,5

	Stainless steel	Highly corrosion resistant steel	Internal diameter	External-Ø	Thickness	Sales unit
	A4	C	D [mm]	d [mm]	S [mm]	[pcs]
Washer 30/1,5/7,5	531161	531162	7,5	30	1.5	100

ACCESSORIES



FNA RB Z - 2-stage plier

Item	Art.-No.	Adapted for	Sales unit
			[pcs]
FNA RB Z	531142	Plier for removal of FNA II RB	1

ACCESSORIES



Air compressed setting tool

Item	Art.-No.	Match	Required for	Sales unit [pcs]
Air compressed setting tool	093731	for FNA II + FNA II RB	-	1
Drop in element	093729	-	Air compressed setting tool Art No. 93731	1
Stop ring	093730	-	Air compressed setting tool Art No. 93731	1
Fitting	093732	-	Air compressed setting tool Art No. 93731	1

LOADS

Nail anchor FNA II RB

stainless steel / high corrosion resistant steel

Highest permissible loads ¹⁾ for a single fixing point ⁶⁾ as part of a multiple fixing of non-structural systems ⁴⁾ in concrete C20/25 up to C50/60 ³⁾ .								Minimum spacings while reducing the load	
Type	Material fixing element	Effective anchorage depth h_{ef} [mm]	Minimum member thickness h_{min} [mm]	Maximum torque moment T_{inst} [Nm]	Permissible load $F_{perm}^{2)}$ [kN]	Required edge distance for c [mm]	Required spacing for s [mm]	Min. spacing $s_{min}^{5)}$ [mm]	Min. edge distance $c_{min}^{5)}$ [mm]
FNA II 6 x 30 RB	A4	30	80	-	2,4	100 for $s \geq 200$	100 for $c \geq 200$	40	40
	C								

For the design the complete approval ETA - 06/0175 has to be considered.

¹⁾ The partial safety factors for material resistance as regulated in the approval as well as a partial safety factor for load actions of $\gamma_L = 1,4$ are considered.

²⁾ Valid for tensile load, shear load and oblique load under any angle. For combinations of tensile loads, shear loads, bending moments as well as reduced edge distances or spacings (anchor groups) see approval.

³⁾ For concrete compressive strength C12/15 see approval.

⁴⁾ Multiple use is defined acc ETAG 001 Part 6 with min. 3 fixing points with min. one anchor per fixing point and a permissible load of 1.4 kN or min. 4 fixing points with min. one anchor an a permissible load of 2.1 kN.

⁵⁾ Minimum possible axial spacings resp. edge distances. Smaller permissible loads acc. approval are required.

⁶⁾ A fixing point is defined as a single anchor or a group of 2 or 4 anchor.

The installation-friendly push-through anchor for multiple fixings



Suspended ceilings with Nonius hangers



Suspended ceilings

VERSIONS

- Zinc-plated steel

BUILDING MATERIALS

Approved for:

- Concrete C20/25 to C50/60, cracked, for the multiple fixings of non-load-bearing systems

Also suitable for:

- Concrete C12/15
- Natural stone with dense structure

CERTIFICATES



ADVANTAGES

- The simple active principle allows for cost-efficient hammer installation.
- The new short version FDN II K with reduced anchorage depth is faster to install and reduces reinforcement hits.
- The flush-sunk expansion nail signifies the complete expansion of the anchor, and thereby ensures minimum movement when under load.
- The Fischer FDN II can be installed without cleaning of the drill hole.
- The head embossing offers a simple control of the anchoring, and thus saves time.

APPLICATIONS

- Wire and Nonius hangers
- Ventilation systems
- Slats
- Metal profiles
- Perforated tapes
- Sub-structures made of metal

FUNCTIONING

- The FDN II is suitable for push-through installation.
- The FDN II ceiling nail is driven into the drill hole with a hammer until it is firmly in position. Do not hit the expansion wedge at this stage.
- Then, drive the expansion wedge in flush to the nail head. This causes the FDN II to expand against the drill hole wall.

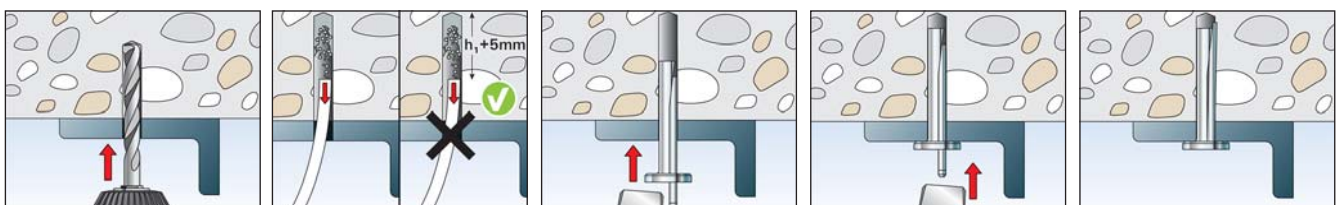

TECHNICAL DATA



Ceiling nail **FDN II**

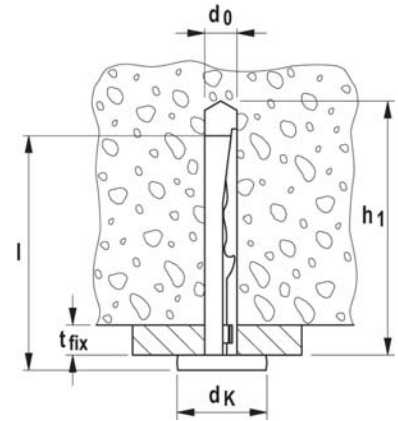

	Art.-No.	Approval ETA	Drill diameter d_0 [mm]	Anchor length l [mm]	Max. usable length t_{fix} [mm]	Min. drill hole depth without cleaning h_1 [mm]	Min. drill hole depth with cleaning h_1 [mm]	Head-Ø d_k [mm]	Sales unit [pcs]
FDN II 6/5	545636	■	6	40	5	47	42	15	100
FDN II 6/35	545637	■	6	70	35	77	72	15	100
FDN II 6/5 K	545638	■	6	33	5	40	35	15	100
FDN II 6/35 K	545639	■	6	64	35	70	65	15	100

LOADS

Ceiling nail FDN II

zinc-plated steel

Permissible loads ¹⁾ for a single fixing point ⁵⁾ as part of a multiple fixing ⁴⁾ in cracked and non-cracked normal concrete of strength classes C20/25 up to C50/60 ³⁾							
Type	Effective anchorage depth h_{ef} [mm]	Min. member thickness h_{min} [mm]	Permissible load F_{perm} ²⁾ [kN]	Required edge distance for maximum load c [mm]	Required spacing for maximum load s [mm]	Min. spacing s_{min} [mm]	Min. edge distance c_{min} [mm]
FDN II 6/5 K	25	80	1,2	70	60	60	70
FDN II 6/35 K	25	80	1,2	70	60	60	70
FDN II 6/5	32	80	1,7	60	50	50	60
FDN II 6/35	32	80	1,7	60	50	50	60

For the design the complete European Technical Assessment ETA-17/0736 has to be considered.

¹⁾ The partial safety factors for material resistance as regulated in the assessment as well as a partial safety factor for load actions of $\gamma_L = 1,4$ are considered.

²⁾ Valid for tensile load, shear load and oblique load under any angle. For shear load with lever arm (bending) see assessment.

³⁾ For concrete strength class C12/15 see assessment.

⁴⁾ A multiple fixing in accordance with ETAG 001 Part 6 is defined by at least 3 fixing points with at least one anchor each and a permissible load per fixing point of 1,4 kN or by at least 4 fixing points with at least one anchor each and a permissible load per fixing point of 2,1 kN.

⁵⁾ A fixing point is defined as a single anchor or a group of 2 or 4 anchors.

The cost-efficient push-through anchor for multiple fixings



Drywall profiles



Suspended ceilings with Nonius hangers

VERSIONS

- Zinc-plated steel

BUILDING MATERIALS

Approved for:

- Concrete C20/25 to C50/60, cracked, for the multiple fixings of non-load-bearing systems

Also suitable for:

- Concrete C12/15
- Natural stone with dense structure

CERTIFICATES



ADVANTAGES

- The simple active principle allows for fast hammer-set installation.
- The efficient anchor offers the perfect price-performance ratio for an economical installation.
- The flush-sunk expansion nail signifies the complete expansion of the anchor, and thereby ensures minimum movement when under load.
- The head embossing offers a simple control of the anchoring, and thus saves time.

APPLICATIONS

- Drywall profiles
- Wire and Nonius hangers
- Ventilation systems
- Slats
- Metal profiles
- Perforated tapes
- Sub-structures made of metal

FUNCTIONING

- The FDZ is suitable for push-through installation.
- The FDZ ceiling nail is driven into the drill hole with a hammer until it is firmly in position. Do not hit the expansion wedge at this stage.
- Then, drive the expansion wedge in flush to the nail head. This causes the FDZ to expand against the drill hole wall.

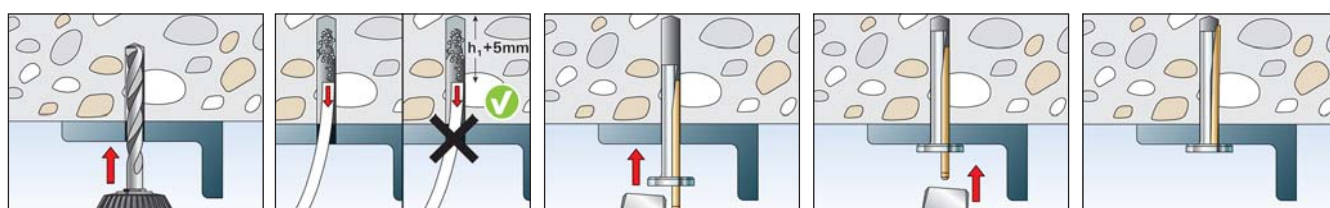

TECHNICAL DATA



Ceiling nail **FDZ**

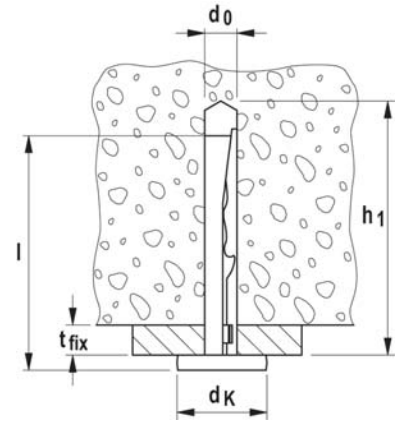

	Art.-No.	Approval ETA	Drill diameter d_0 [mm]	Anchor length l [mm]	Max. usable length t_{fix} [mm]	Min. drill hole depth without cleaning h_1 [mm]	Min. drill hole depth with cleaning h_1 [mm]	Head-Ø d_k [mm]	Sales unit [pcs]
FDZ 6/5	544103	■	6	40	5	47	42	15	200
FDZ 6/35	544104	■	6	70	35	77	72	15	200

LOADS

Ceiling nail FDZ
zinc-plated steel

Permissible loads ¹⁾ for a single fixing point ⁵⁾ as part of a multiple fixing ⁴⁾ in cracked and non-cracked normal concrete of strength classes C20/25 up to C50/60 ³⁾							
Type	Effective anchorage depth h_{ef} [mm]	Min. member thickness h_{min} [mm]	Permissible load $F_{perm}^{2)}$ [kN]	Required edge distance for maximum load c [mm]	Required spacing for maximum load s [mm]	Min. spacing s_{min} [mm]	Min. edge distance c_{min} [mm]
FDZ 6/5	32	80	1,0	60	50	50	60
FDZ 6/35	32	80	1,0	60	50	50	60

For the design the complete European Technical Assessment ETA-17/0737 has to be considered.

¹⁾ The partial safety factors for material resistance as regulated in the assessment as well as a partial safety factor for load actions of $\gamma_L = 1,4$ are considered.

²⁾ Valid for tensile load, shear load and oblique load under any angle. For shear load with lever arm (bending) see assessment.

³⁾ For concrete strength class C12/15 see assessment.

⁴⁾ A multiple fixing in accordance with ETAG 001 Part 6 is defined by at least 3 fixing points with at least one anchor each and a permissible load per fixing point of 1,4 kN or by at least 4 fixing points with at least one anchor each and a permissible load per fixing point of 2,1 kN.

⁵⁾ A fixing point is defined as a single anchor or a group of 2 or 4 anchors.

The cost-efficient fixing for flexible use in non-cracked concrete



Column bases



Stormwater overflow tank manholes

VERSIONS

- Zinc-plated steel
- Stainless steel
- Hot-dip galvanised steel (with variable working life for outdoor areas)

BUILDING MATERIALS

Approved for:

- Concrete C20/25 to C50/60, non-cracked

Also suitable for:

- Concrete C12/15
- Natural stone with dense structure

CERTIFICATES



ADVANTAGES

- The standard anchorage depth achieves the maximum load-bearing capacities.
- The reduced anchorage depth reduces the drill hole depth. This minimises the amount of time needed for installation whilst increasing flexibility.
- Additional short version „K“ with short anchoring depth.
- The long thread balances component tolerances and allows for stand-off installations, thus increasing flexibility.
- Few hammer blows and the minimal torque slippage allow for a noticeably simpler installation.
- The drive-in pin protects the thread from damage, and thus ensures a faster installation and dismantling of the attachment.
- The larger washer included with the FBN II GS creates a larger supporting surface and, as such, allows for the fixing of wood constructions.
- When using hollow drills with suction is no drill hole cleaning required.
- New ETA assessment for hot-dip galvanised version for variable working life in outdoor areas.

APPLICATIONS

- Steel constructions
- Guard rails
- Consoles
- Ladders
- Cable trays
- Machines
- Staircases
- Gates
- Façades

FUNCTIONING

- The FBN II is suitable for pre-positioned and push-through installation; also suitable for stand-off installation under certain conditions.
- Prior to installation, place the hexagon nut in the optimal position (the drive-in pin projects by approx. 3 mm out of the hexagon nut).
- When applying the torque, the cone bolt is pulled into the expansion clip and expands it against the drill hole wall.
- The head embossing offers a simple control of the anchoring.
- In the case of series installation, we recommend using the FABS bolt anchor setting tool.

INSTALLATION

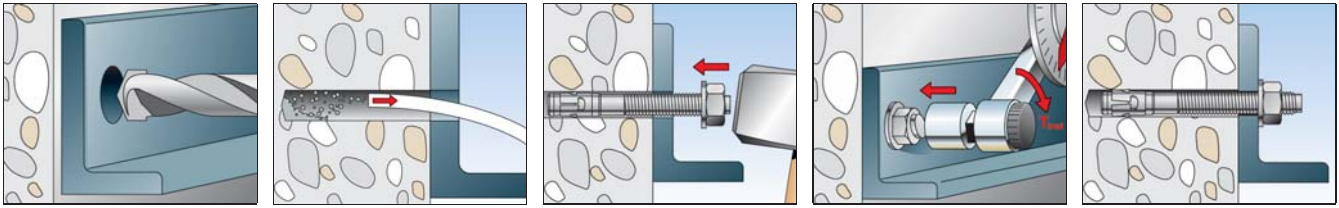

TECHNICAL DATA



Bolt anchor **FBN II**

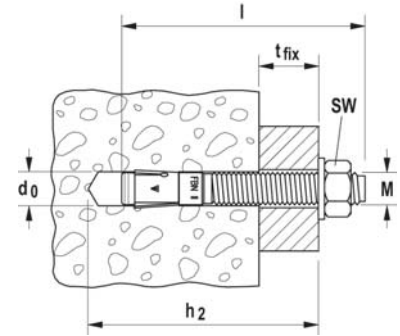

Item	Zinc-plated steel	Stainless steel	Hot-dip galvanized steel	Approval ETA	Drill hole diameter	Min. drill hole depth for through fixings	Anchor length	Max. usable length hef,max./hef,min.	Thread	Width across nut	Sales unit
	Art.-No.	Art.-No.	Art.-No.		d_0 [mm]	h_2 [mm]	l [mm]	t_{fix} [mm]	\emptyset x length [mm]	\emptyset SW [mm]	[pcs]
	gvz	A4	hdg								
FBN II 6/5	505526 ¹⁾²⁾	—	—	■	6	45	50	5/-	M 6 x 12	10	100
FBN II 6/10	505527 ¹⁾²⁾	505532 ¹⁾²⁾	—	■	6	50	55	10/-	M 6 x 17	10	100
FBN II 6/30	505528 ¹⁾²⁾	505535 ¹⁾²⁾	—	■	6	70	75	30/-	M 6 x 35	10	100
FBN II 8/5	040662	—	—	■	8	61	66	5/15	M 8 x 34	13	50
FBN II 8/10	040664	507555	507575	■	8	66	71	10/20	M 8 x 39	13	50
FBN II 8/20	040669	—	—	■	8	76	81	20/30	M 8 x 49	13	50
FBN II 8/30	040700	507556	507576	■	8	86	91	30/40	M 8 x 59	13	50
FBN II 8/50	040771	507557	507577	■	8	106	111	50/60	M 8 x 79	13	50
FBN II 8/70	040777	—	507578	■	8	126	131	70/80	M 8 x 99	13	20
FBN II 8/100	040783	—	—	■	8	156	161	100/110	M 8 x 129	13	20
FBN II 10/10	040827	507558	507579	■	10	78	86	10/20	M 10 x 46	17	50
FBN II 10/20	040851	507559	—	■	10	88	96	20/30	M 10 x 56	17	50
FBN II 10/30	040854	—	—	■	10	98	106	30/40	M 10 x 66	17	—
FBN II 10/30	—	507560	507580	■	10	98	106	30/40	M 10 x 66	17	50
FBN II 10/50	040855	507561	507582	■	10	118	126	50/60	M 10 x 86	17	20
FBN II 10/70	040931	—	—	■	10	138	146	70/80	M 10 x 106	17	20
FBN II 10/100	040943	507562	507583	■	10	168	176	100/110	M 10 x 136	17	20
FBN II 10/140	040944	—	—	■	10	208	216	140/150	M 10 x 176	17	20
FBN II 10/160	040945	—	—	■	10	228	236	160/170	M 10 x 196	17	20
FBN II 12/10	040950	507563	507589	■	12	95	106	10/25	M 12 x 59	19	20
FBN II 12/20	044558	507564	—	■	12	105	116	20/35	M 12 x 69	19	20
FBN II 12/30	045263	507565	507591	■	12	115	126	30/45	M 12 x 79	19	20
FBN II 12/50	045264	507566	507592	■	12	135	146	50/65	M 12 x 99	19	20
FBN II 12/80	045265	—	—	■	12	165	176	80/95	M 12 x 129	19	20
FBN II 12/100	045266	507567	507596	■	12	185	196	100/115	M 12 x 149	19	20
FBN II 12/120	045267	—	—	■	12	205	216	120/135	M 12 x 169	19	20
FBN II 12/140	045268	—	—	■	12	225	236	140/155	M 12 x 189	19	20
FBN II 12/160	045269	—	—	■	12	245	256	160/175	M 12 x 189	19	20
FBN II 16/10	—	507568	—	■	16	114	130	10/25	M 16 x 74	24	10
FBN II 16/25	045564	507569	507598	■	16	129	145	25/40	M 16 x 89	24	10
FBN II 16/50	045565	507570	507553	■	16	154	170	50/65	M 16 x 105	24	10
FBN II 16/80	045566	—	—	■	16	184	200	80/95	M 16 x 144	24	10
FBN II 16/100	045567	—	507554	■	16	204	220	100/115	M 16 x 164	24	10
FBN II 16/140	045568	—	—	■	16	244	260	140/155	M 16 x 184	24	10

1) Use restricted to anchoring of structural components which are statically indeterminate.

2) Nut and washer not pre-assembled/supplied loose.

TECHNICAL DATA



Bolt anchor **FBN II**

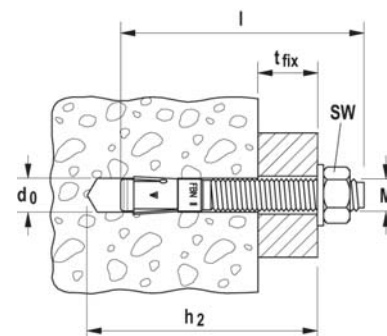

	Zinc-plated steel	Stainless steel	Hot-dip galvanised steel	Approval	Drill hole diameter	Min. drill hole depth for through fixings	Anchor length	Max. usable length hef,max./hef,min.	Thread	Width across nut	Sales unit
	Art.-No.	Art.-No.	Art.-No.	ETA	d_0 [mm]	h_2 [mm]	l [mm]	t_{fix} [mm]	$\emptyset \times$ length [mm]	\circ SW [mm]	[pcs]
Item	gvz	A4	hdg								
FBN II 16/160	045569	—	—	■	16	264	280	160/175	M 16 x 184	24	10
FBN II 16/200	045570	—	—	■	16	304	320	200/215	M 16 x 184	24	10
FBN II 20/30	045573	507571	508015	■	20	165	187	30/55	M 20 x 90	30	10
FBN II 20/60	045574	507572	—	■	20	195	217	60/85	M 20 x 90	30	10
FBN II 20/80	045575	—	—	■	20	215	237	80/105	M 20 x 90	30	10
FBN II 20/120	045576	—	—	■	20	255	277	120/145	M 20 x 90	30	10

1) Use restricted to anchoring of structural components which are statically indeterminate.

2) Nut and washer not pre-assembled/supplied loose.

TECHNICAL DATA



Bolt anchor **FBN II K**

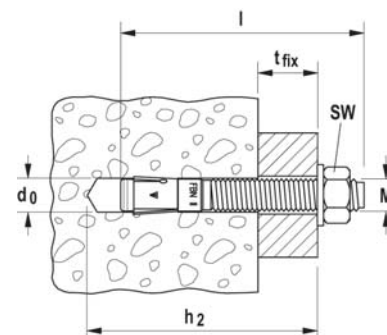

	Zinc-plated steel, short version	Stainless steel, short version	Hot-dip galvanised steel, short version	Approval	Drill hole diameter	Min. drill hole depth for through fixings	Anchor length	Max. usable length hef,max./hef,min.	Thread	Width across nut	Sales unit
	Art.-No.	Art.-No.	Art.-No.	ETA	d_0 [mm]	h_2 [mm]	l [mm]	t_{fix} [mm]	$\emptyset \times$ length [mm]	\circ SW [mm]	[pcs]
Item	gvz	A4	hdg								
FBN II 8/5 K	040806	508007	508012	■	8	51	56	-/5	M 8 x 24	13	50
FBN II 8/10 K	040807	—	—	■	8	56	61	-/10	M 8 x 29	13	50
FBN II 10/5 K	040946	508010	508013	■	10	63	71	-/5	M 10 x 31	17	50
FBN II 10/10 K	040947	—	—	■	10	68	76	-/10	M 10 x 36	17	50
FBN II 12/5 K	045272	508011	508014	■	12	75	86	-/5	M 12 x 39	19	20
FBN II 12/10 K	045273	—	—	■	12	80	91	-/10	M 12 x 44	19	20
FBN II 12/30 K	045274	—	—	■	12	100	111	-/30	M 12 x 64	19	20
FBN II 16/15 K	045571	508745	507597	■	16	104	120	-/15	M 16 x 64	24	10
FBN II 16/25 K	045572	—	—	■	16	114	130	-/25	M 16 x 74	24	10
FBN II 20/10 K	045577	—	—	■	20	120	142	-/10	M 20 x 50	30	10

TECHNICAL DATA



Bolt anchor **FBN II-GS** with large washer

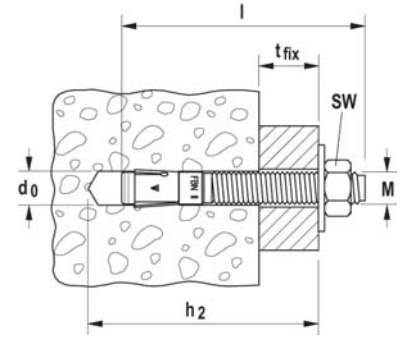

High performance steel anchors 4

Item	Steel, zinc-plated, with large washer	Approval ETA	Drill hole diameter	Min. drill hole depth for through fixings	Anchor length	Max. usable length hef,max./ hef,min.	Thread	Width across nut	Washer (outer diameter x thickness)	Sales unit
	Art.-No.		d_0 [mm]	h_2 [mm]	l [mm]	t_{fix} [mm]	\emptyset x length [mm]	\emptyset SW [mm]	[mm]	[pcs]
	gvz									
FBN II 12/80 GS	045578	■	12	165	176	80/95	M 12 x 129	19	44 x 4	20
FBN II 12/100 GS	045579	■	12	185	196	100/115	M 12 x 149	19	44 x 4	20
FBN II 12/120 GS	045580	■	12	205	216	120/135	M 12 x 169	19	44 x 4	20
FBN II 12/140 GS	045581	■	12	225	236	140/155	M 12 x 189	19	44 x 4	10
FBN II 12/160 GS	045583	■	12	245	256	160/175	M 12 x 189	19	44 x 4	10
FBN II 12/180 GS	045584	■	12	265	276	180/195	M 12 x 189	19	44 x 4	10
FBN II 12/200 GS	045585	■	12	285	296	200/215	M 12 x 189	19	44 x 4	10
FBN II 12/250 GS	045586	■	12	335	346	250/265	M 12 x 100	19	44 x 4	10
FBN II 16/100 GS	045588	■	16	204	220	100/115	M 16 x 164	24	56 x 5	10
FBN II 16/140 GS	045590	■	16	244	260	140/155	M 16 x 184	24	56 x 5	10
FBN II 16/160 GS	045591	■	16	264	280	160/175	M 16 x 184	24	56 x 5	10
FBN II 16/200 GS	045593	■	16	304	320	200/215	M 16 x 100	24	56 x 5	10

ACCESSORIES



fischer Anchor bolt setting tool **FABS**

Item	Art.-No.	Matching anchor type	Sales unit [pcs]
FABS	077937	FAZ II, FBN II, EXA for diameter from M6 - M12	1

LOADS

Bolt anchor FBN II

zinc plated steel / stainless steel / hot dip galvanised steel

Permissible loads of a single anchor in non-cracked normal concrete (concrete compression zone) of strength class C20/25 (~B25) ¹⁾²⁾³⁾										Minimum spacings while reducing the load	
Type	Material fixing element	Min. member thickness	Effective anchorage depth	Installation torque	Permissible tensile load	Permissible shear load	Required edge distance (with one edge) for		Required spacing for	Min. spacing	Min. edge distance
							Max. tension load c	Max. shear load c			
		h_{min} [mm]	h_{ef} [mm]	T_{inst} [Nm]	$N_{perm}^{4)}$ [kN]	$V_{perm}^{4)}$ [kN]	[mm]	[mm]	Max. Load s [mm]	$s_{min}^{5)6)}$ [mm]	$c_{min}^{5)6)}$ [mm]
FBN II 6	gvz	100	30 ⁸⁾	4	2,9	3,4	100	60	90	40	40
	A4			4	2,9	3		55			
FBN II 8	gvz	100	30 ⁸⁾	15	2,9	7,1	65	115	90	40	40
	A4			10	2,9	7,1		115		50	45
	gvz	100	40	15	6,1	7,6	95	120	120	40	40
	A4			10		7,3		115			45
	hdg			15		7,6		120			40
FBN II 10	gvz	100	40	30	6,1	12,0	100	190	120	50	80
	A4			20		11,6		185			
	gvz	100	50	30	8,5	12,0	100	185	150	50	50
	A4			20		11,6		180		70	55
	hdg			30		12,0		185		50	50
FBN II 12	gvz	100	50	50	8,5	17,9	145	280	150	70	100
	A4			35		15,7		245			
	gvz	120	65	50	12,6	17,9	145	245	195	70	70
	A4			35		15,7		215			
	hdg			40		17,9		245			
FBN II 16	gvz	120	65	100	12,6	29,0	175	410	195	90	120
	A4			80							
	gvz	160	80	100	17,2	31,5	175	375	240	90	90
	A4			80		29,1		340		120	80
	hdg			70		31,5		375		90	90
FBN II 20	gvz	160	80	200	17,2	38,3	185	455	240	120	120
	A4			150		39,6		470		140	
	gvz	200	105	200	25,9	38,3	185	385	315	120	120
	A4			150		49,1		510			
	hdg			200		38,3		385			

For the design the complete assessment ETA-07/0211 has to be considered. ⁷⁾

¹⁾ The partial safety factors for material resistance as regulated in the ETA-07/0211 as well as a partial safety factor for load actions of $\gamma_L = 1,4$ are considered. As an single anchor counts e.g. an anchor with a spacing $s \geq 3 \cdot h_{ef}$ and an edge distance $c \geq 1,5 \cdot h_{ef}$. Accurate data see ETA-07/0211.

²⁾ For higher concrete strength classes up to C50/60 higher permissible loads may be possible.

³⁾ Drill method Hammer drilling resp. hollow drilling.

⁴⁾ For combinations of tensile loads, shear loads, bending moments as well as reduced edge distances or spacings (anchor groups) see ETA-07/0211.

⁵⁾ Minimum possible axial spacings resp. edge distance while reducing the permissible load.

⁶⁾ Minimum possible spacing resp. edge distance while reducing the permissible load for the required minimum member thickness. The combination of minimum edge distance and minimum spacing is not possible. One of both values has to be increased acc. ETA-07/0211.

⁷⁾ The given loads refer to the European Technical Assessment ETA-07/0211, issue date 19/05/2016. Design of the loads according ETAG 001, Annex C, Method A (for static resp. quasi-static loads).

⁸⁾ Anchoring depth smaller than 40 mm are only approved for statically indeterminate systems.

The installation-friendly internally threaded anchor for fixings in non-cracked concrete



Fall protection devices

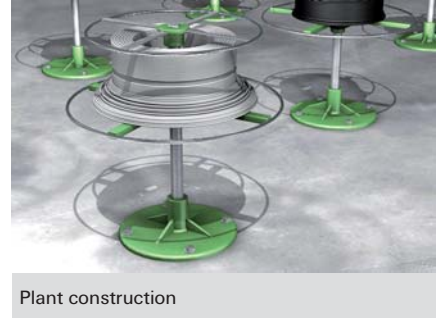

Plant construction

High performance steel anchors 4

VERSIONS

- Zinc-plated steel

BUILDING MATERIALS

Approved for:

- Concrete C20/25 to C50/60, non-cracked

Also suitable for:

- Concrete C12/15
- Natural stone with dense structure

CERTIFICATES

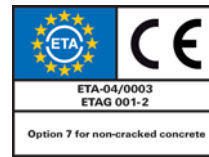

ADVANTAGES

- The optimised geometry minimises setting energy and allows for use in extremely narrow spaces. This allows for user-friendly installation.
- The three-part expansion sleeve creates even load distribution, thus allowing small edge and axial spacing. Thus the TA M is extremely flexible.
- The metric internal thread allows to use standard screws or threaded rods for the ideal adaptation to suit the intended use.
- The red plastic cap protects against soiling and thus ensures free-running of the thread.

APPLICATIONS

- Steel constructions
- Handrails
- Consoles
- Ladders
- Cable trays
- Machines
- Staircases
- Gates
- Façades
- Stand-off installations

FUNCTIONING

- The TAM is suitable for pre-positioned installation.
- When applying the torque, the cone is pulled into the expansion sleeve and expands it against the drill hole wall.
- For correct installation, it must be ensured that the pre-positioned anchor TA M can be supported on the attachment, or that the threaded rod is countered.
- Determining the screw length l_s :
Screw length $l_s =$
Length of fixing
+ Thickness of fixture t_{fix}
+ Thickness of washer.

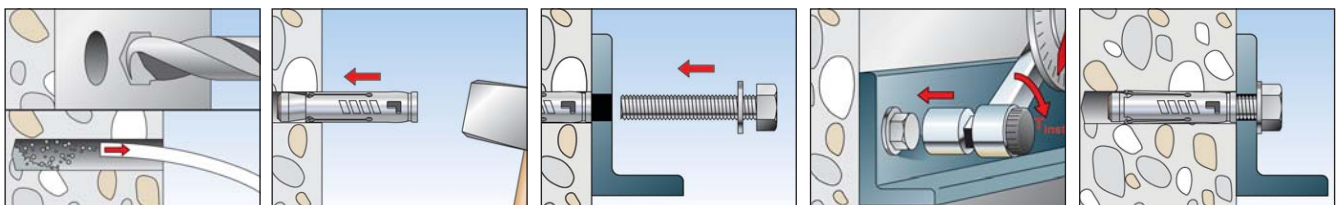

TECHNICAL DATA



Heavy-duty anchor **TA M**

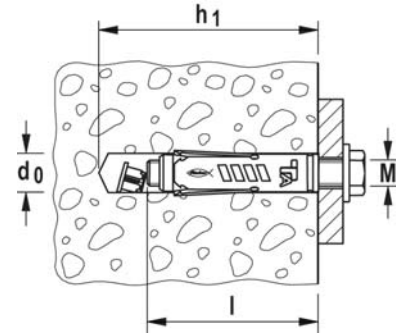

	Zinc-plated steel	Approval	Drill hole diameter	Min. drill hole depth	Anchor length	Thread	Sales unit		
Item	gvz	ETA	d_0 [mm]	h_1 [mm]	l [mm]	M	[pcs]		
TA M6	090245	■	10	65	49	M 6	50		
TA M8	090246	■	12	70	56	M 8	50		
TA M10	090247	■	15	90	69	M 10	25		
TA M12	090248	■	18	105	86	M 12	25		

TECHNICAL DATA



Heavy-duty anchor **TA M-S** with screw

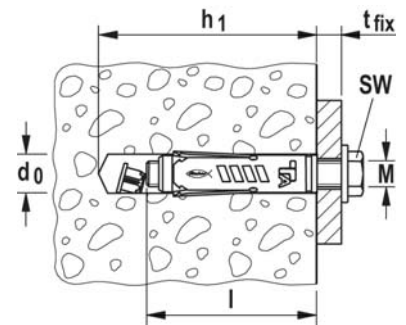

	Zinc-plated steel	Approval	Drill hole diameter	Min. drill hole depth	Anchor length	Max. fixture thickness	Screw	Width across nut	Sales unit
Item	gvz	ETA	d_0 [mm]	h_1 [mm]	l [mm]	t_{fix} [mm]	\emptyset x length	\emptyset SW [mm]	[pcs]
TA M6 S/10	090249	■	10	65	49	10	M 6 x 60	10	50
TA M8 S/10	090250	■	12	70	56	10	M 8 x 65	13	50
TA M10 S/20	090251	■	15	90	69	20	M 10 x 90	17	25
TA M12 S/25	090252	■	18	105	86	25	M 12 x 110	19	20

LOADS

Heavy-duty anchor TA M

zinc plated steel

Permissible loads of a single anchor in non-cracked normal concrete (concrete compression zone) of strength class C20/25 (~B25) ^{1) 2) 3)}										Minimum spacings while reducing the load	
Type	Screw material resp. screw surface	Min. member thickness h_{min} [mm]	Effective anchorage depth h_{ef} [mm]	Installation torque T_{inst} [Nm]	Permissible tensile load $N_{perm}^{4)}$ [kN]	Permissible shear load $V_{perm}^{4)}$ [kN]	Required edge distance (with one edge) for		Required spacing for Max. Load s [mm]	Min. spacing $s_{min}^{5) 6)}$ [mm]	Min. edge distance $c_{min}^{5) 6)}$ [mm]
							Max. tension load c [mm]	Max. shear load c [mm]			
TA M6	8.8	100	40	10	3,6	3,3	50	55	120	80	50
TA M8	8.8	100	45	20	5,7	6,7	65	95	135	90	60
TA M10	8.8	110	55	40	9,5	11,0	160	150	165	110	70
TA M12	8.8	140	70	75	11,9	17,0	170	200	210	160	120

¹⁾ For the design the complete assessment ETA-04/0003 has to be considered. ²⁾

²⁾ The partial safety factors for material resistance as regulated in the ETA-04/0003 as well as a partial safety factor for load actions of $\gamma_L = 1.4$ are considered. As an single anchor counts e.g. an anchor with a spacing $s \geq 3 \cdot h_{ef}$ and an edge distance $c \geq 1.5 \cdot h_{ef}$. Accurate data see ETA-04/0003.

³⁾ For higher concrete strength classes up to C50/60 higher permissible loads may be possible.

⁴⁾ Drill method hammer drilling.

⁵⁾ For combinations of tensile loads, shear loads, bending moments as well as reduced edge distances or spacings (anchor groups) see ETA-04/0003.

⁶⁾ Minimum possible axial spacings resp. edge distance while reducing the permissible load.

⁷⁾ Minimum possible spacing resp. edge distance while reducing the permissible load for the required minimum member thickness. The combination of minimum edge distance and minimum spacing is not possible. One of both values has to be increased acc. ETA-04/0003.

⁸⁾ The given loads refer to the European Technical Approval ETA-04/0003, issue date 11/06/2013. Design of the loads according ETAG 001, Annex C, Method A (for static resp. quasi-static loads).

TECHNICAL DATA



Heavy-duty anchor **SL M**

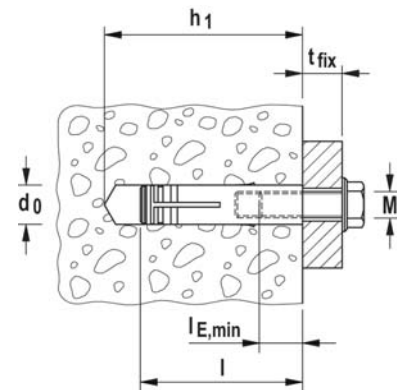

	Zinc-plated steel	Drill hole diameter	Min. drill hole depth	Anchor length	Internal thread	Min. bolt penetration	Sales unit	
	Art.-No.	d_0 [mm]	h_1 [mm]	l [mm]	A1	$l_{E,min}$ [mm]	[pcs]	
Item	gvz							
SL M 16	050556	24	110	90	M 16	90	10	
SL M 20	050557	30	130	110	M 20	110	5	
SL M 24	050558	35	150	125	M 24	125	5	

TECHNICAL DATA



Heavy-duty anchor **SLM-N A4**

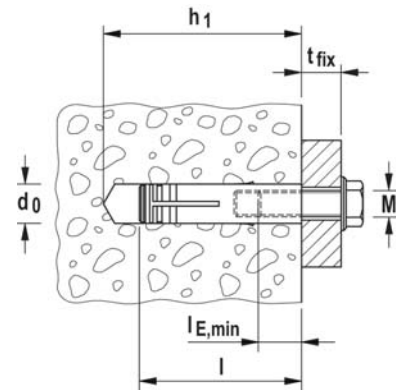

	Stainless steel	Drill hole diameter	Min. drill hole depth	Anchor length	Internal thread	Min. bolt penetration	Sales unit	
	Art.-No.	d_0 [mm]	h_1 [mm]	l [mm]	A1	$l_{E,min}$ [mm]	[pcs]	
Item	A4							
SL M 8 N A4	050526	12	60	54	M 8	52	25	
SL M 10 N A4	050527	16	70	62	M 10	62	20	

LOADS

Heavy-duty anchor SL M

zinc plated steel / stainless steel

Recommended loads¹⁾³⁾ of a single anchor in non-cracked normal concrete (concrete compression zone) of strength class C20/25.

Type	Effective anchorage-depth	Min. member thickness	Torque-moment	Recommended load	Char. spacing	Char. edge distance	Min. spacing	Min. edge distance
	h_{ef} [mm]	h_{min} [mm]	T_{inst} [Nm]	$F_{rec}^{2)}$ [kN]	$s_{cr,N}$ [mm]	$c_{cr,N}$ [mm]	$s_{min}^{4)}$ [mm]	$c_{min}^{4)}$ [mm]
SL M 8 N A4	45	100	25	3,5	135	68	50	90
SL M 10 N A4	50	100	50	5,0	150	75	50	100
SL M 16 gvz	62	130	100	8,0	186	93	60	120
SL M 20 gvz	77	150	150	11,0	231	116	80	160
SL M 24 gvz	90	200	200	13,9	270	135	90	180

¹⁾ Required safety factors are considered.

²⁾ Valid for tensile load, shear load and oblique load under any angle.

³⁾ Valid for screws with grade 8.8 and A4-70

⁴⁾ Minimum possible axial spacings resp. edge distance while reducing the recommended load.

The installation-friendly push-through anchor for fixings in non-cracked concrete

High performance steel anchors 4



Collision protection



Benches

VERSIONS

- Zinc-plated steel

BUILDING MATERIALS

Approved for:

- Concrete C20/25 to C50/60, non-cracked

Also suitable for:

- Concrete C12/15
- Natural stone with dense structure

CERTIFICATES



ADVANTAGES

- The optimised geometry minimises setting energy and allows for use in extremely narrow spaces. This allows for user-friendly installation.
- The three-part expansion sleeve creates even load distribution, thus allowing small edge and axial spacing. Thus the TA M-T is extremely flexible.
- The TA M-BP version with twist-off head hinders the dismantling of the fixture for use as a theft-deterrent and break-in protection.
- The detachable screw connection allows for surface flush removal.

APPLICATIONS

- Steel constructions
- Handrails
- Consoles
- Ladders
- Cable trays
- Machines
- Staircases
- Gates
- Façades

FUNCTIONING

- The TA M-T is suitable for push-through installation.
- When applying the torque, the cone is pulled into the expansion sleeve and expands it against the drill hole wall.
- The hexagonal head of the TA M-BP is tightened until it breaks off.

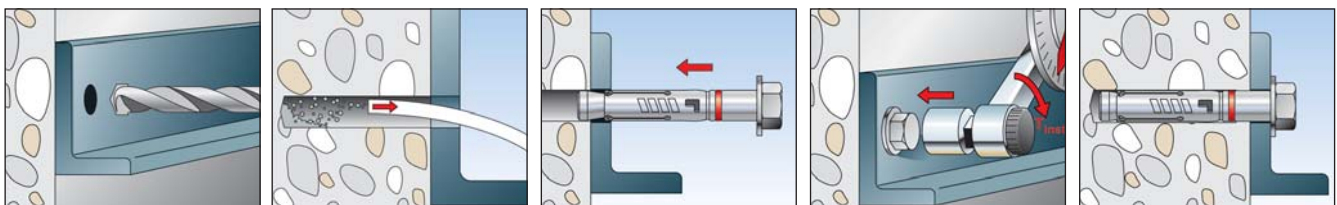

TECHNICAL DATA



Heavy-duty anchor **TA M-T**,
for push-through installation

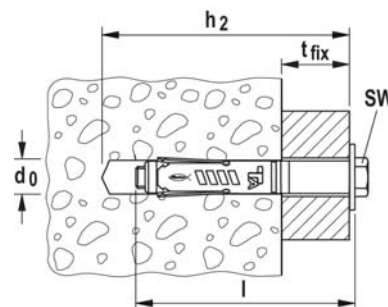

	Zinc-plated steel	Approval	Drill hole diameter	Min. drill hole depth for through fixings	Anchor length	Max. fixture thickness	Thread	Width across nut	Sales unit
	Art.-No.	ETA	d_0 [mm]	h_2 [mm]	l [mm]	t_{fix} [mm]	M	\circ SW [mm]	[pcs]
Item	gvz								
TA M8 T/25 S	090268	■	12	95	84	25	M 8	13	50
TA M10 T/25 S	090269	■	15	110	100	25	M 10	17	25
TA M12 T/25 S	090270	■	18	120	114	25	M 12	19	20

TECHNICAL DATA



Heavy-duty anchor **TA M-T BP**,
with twist-off head

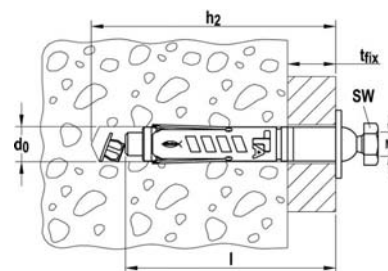

	Zinc-plated steel	Drill hole diameter	Min. drill hole depth for through fixings	Anchor length	Max. fixture thickness	Thread	Width across nut	Sales unit
	Art.-No.	d_0 [mm]	h_2 [mm]	l [mm]	t_{fix} [mm]	M	\circ SW [mm]	[pcs]
Item	gvz							
TA M8 BP	090265	12	95	84	25	M 8	13	50

LOADS

Heavy-duty anchor TA M-T

zinc plated steel

Permissible loads of a single anchor in non-cracked normal concrete (concrete compression zone) of strength class C20/25 (~B25) ^{1) 2) 3)}										Minimum spacings while reducing the load	
Type	Material fixing element	Min. member thickness	Effective anchorage depth	Installation torque	Permissible tensile load	Permissible shear load	Required edge distance (with one edge) for		Required spacing for	Min. spacing	Min. edge distance
							Max. tension load	Max. shear load			
		h_{min} [mm]	h_{ef} [mm]	T_{inst} [Nm]	$N_{perm}^{4)}$ [kN]	$V_{perm}^{4)}$ [kN]	Max. tension load c [mm]	Max. shear load c [mm]	Max. Load s [mm]	$s_{min}^{5) 6)}$ [mm]	$c_{min}^{5) 6)}$ [mm]
TA M8 T	gvz	100	45	20	5,7	6,7	65	95	135	90	60
TA M10 T	gvz	110	55	40	9,5	11,0	160	150	165	110	70
TA M12 T	gvz	140	70	75	11,9	17,0	170	200	210	160	120

For the design the complete assessment ETA-04/0003 has to be considered. ²⁾

¹⁾ The partial safety factors for material resistance as regulated in the ETA-04/0003 as well as a partial safety factor for load actions of $\gamma_L = 1.4$ are considered. As an single anchor counts e.g. an anchor with a spacing $s \geq 3 \cdot h_{ef}$ and an edge distance $c \geq 1.5 \cdot h_{ef}$. Accurate data see ETA-04/0003.

²⁾ For higher concrete strength classes up to C50/60 higher permissible loads may be possible.

³⁾ Drill method hammer drilling.

⁴⁾ For combinations of tensile loads, shear loads, bending moments as well as reduced edge distances or spacings (anchor groups) see ETA-04/0003.

⁵⁾ Minimum possible axial spacings resp. edge distance while reducing the permissible load.

⁶⁾ Minimum possible spacing resp. edge distance while reducing the permissible load for the required minimum member thickness. The combination of minimum edge distance and minimum spacing is not possible. One of both values has to be increased acc. ETA-04/0003.

⁷⁾ The given loads refer to the European Technical Approval ETA-04/0003, issue date 11/06/2013. Design of the loads according ETAG 001, Annex C, Method A (for static resp. quasi-static loads).

The push-through anchor for structural fixings in non-cracked concrete

High performance steel anchors 4



Bicycle racks

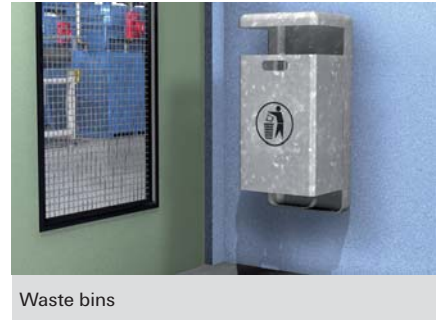

Waste bins

VERSIONS

- Zinc-plated steel

BUILDING MATERIALS

Suitable for:

- Concrete C12/15 to C20/25, non-cracked
- Natural stone with dense structure

ADVANTAGES

- The optimised geometry minimises setting energy and enables the use in extremely narrow spaces. This allows for user-friendly installation.
- The anchor design makes it possible to use different head shapes for flexible design solutions: Hexagon head (type S), bolt version with nut and washer (type B).
- The detachable screw connection allows for surface flush removal.

APPLICATIONS

- Handrails
- Consoles
- Ladders
- Cable trays
- Gates
- Façades
- Temporary or structural fixings

FUNCTIONING

- The FSA is suitable for push-through installation.
- When applying the torque, the cone is pulled into the expansion sleeve and expands it against the drill hole wall.
- The half-moon shaped recesses act as a crumple zone to take the torque slippage, so that the attachment is pulled onto the anchor base.

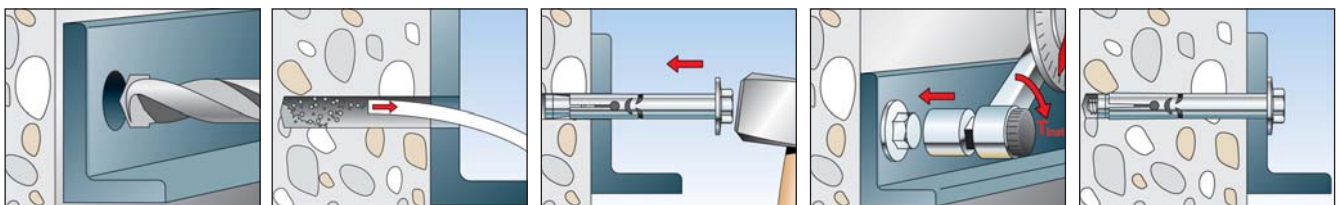

TECHNICAL DATA



Sleeve anchor **FSA-S**

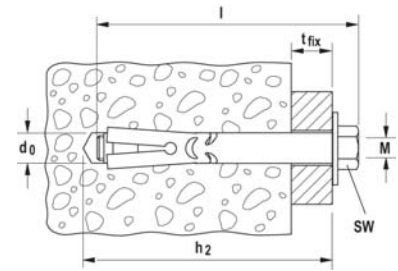

	Zinc-plated steel	Drill hole diameter	Min. drill hole depth for through fixings	Max. fixture thickness	Anchor length	Thread	Width across nut	Sales unit
	Art.-No.	d ₀ [mm]	h ₂ [mm]	t _{fix} [mm]	l [mm]	M	○ SW [mm]	[pcs]
Item	gvz							
FSA 8/15 S	068520	8	65	15	64	M 6	10	50
FSA 8/40 S	068521	8	90	40	89	M 6	10	50
FSA 8/65 S	068522	8	115	65	114	M 6	10	50
FSA 10/10 S	068523	10	65	10	65	M 8	13	20
FSA 10/35 S	068524	10	90	35	90	M 8	13	20
FSA 10/60 S	068525	10	115	60	115	M 8	13	20
FSA 12/10 S	068526	12	75	10	76	M 10	17	20
FSA 12/25 S	068527	12	90	25	91	M 10	17	20
FSA 12/50 S	068528	12	115	50	116	M 10	17	20

TECHNICAL DATA



Sleeve anchor **FSA-B**

	Zinc-plated steel	Drill hole diameter	Min. drill hole depth for through fixings	Max. fixture thickness	Anchor length	Thread	Width across nut	Sales unit
	Art.-No.	d ₀ [mm]	h ₂ [mm]	t _{fix} [mm]	l [mm]	M	○ SW [mm]	[pcs]
Item	gvz							
FSA 8/15 B	068500	8	65	15	65	M 6	10	50
FSA 8/40 B	068501	8	90	40	90	M 6	10	50
FSA 8/65 B	068502	8	115	65	115	M 6	10	50
FSA 10/10 B	068503	10	65	10	69	M 8	13	20
FSA 10/35 B	068504	10	90	35	94	M 8	13	20
FSA 10/60 B	068505	10	115	60	119	M 8	13	20
FSA 12/10 B	068506	12	75	10	81	M 10	17	20
FSA 12/25 B	068507	12	90	25	96	M 10	17	20
FSA 12/50 B	068508	12	115	50	121	M 10	17	20
FSA 12/75 B	068509	12	140	75	146	M 10	17	20

LOADS

Sleeve anchor FSA zinc plated steel

Recommended loads¹⁾ of a single anchor in non-cracked normal concrete (concrete compression zone) of strength class C20/25.

Type	Effective anchorage-depth h_{ef} [mm]	Minimum member thickness h_{min} [mm]	Torque-moment T_{inst} [Nm]	Recommended Tensile load $N_{rec}^{2)}$ [kN]	Recommended shear load $V_{rec}^{2)}$ [kN]	Char. spacing $s_{cr,N}$ [mm]	Char. edge distance $c_{cr,N}$ [mm]	Min. spacing $s_{min}^{3)}$ [mm]	Min. edge distance $c_{min}^{3)}$ [mm]
FSA 8	35	70	8	2,0	3,4	105	53	70	50
FSA 10	40	80	25	3,5	6,3	120	60	80	60 ⁴⁾
FSA 12	50	100	40	5,0	9,9	150	75	100	75 ⁴⁾

¹⁾ Required safety factors are considered.

²⁾ For combination of tensile and shear loads a detailed anchor design is necessary.

³⁾ Minimum possible axial spacings resp. edge distance while reducing the recommended load.

⁴⁾ No reduction of the recommended tensile load.

The reusable fixing system for diamond drills and saws



Diamond drills

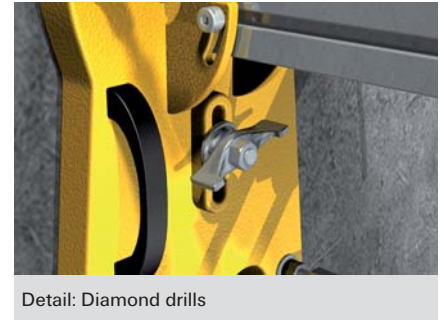

Detail: Diamond drills

VERSIONS

- Zinc-plated steel

BUILDING MATERIALS

Suitable for:

- Concrete C12/15 to C50/60, non-cracked
- Natural stone with dense structure

ADVANTAGES

- The detachable screw connection between the expansion element and spindle enables simple dismantling and ensures that the spindle bolt can be reused.
- The robust, reusable spindle bolt guarantees a long life span.
- The active principle of the anchor bolt enables an active controlled expansion, thus offering a high level of safety.
- The large steel cross-section provides high shear load-bearing capability and, as such, high security for the jerky stoppage of the drill bit.

APPLICATIONS

- Diamond and core drilling devices
- Diamond saws

FUNCTIONING

- The FDBB is suitable for pre-positioned and push-through installation.
- An expansion element must be added to the spindle bolt before installation.
- Use a hammer to drive the FDBB through the base plate of the drilling device into the drill hole.
- When the nut is tightened, the cone bolt is pulled into the expansion clip and expands it against the drill hole wall.
- The expansion element remains in the drill hole when dismantling the spindle bolt. The spindle bolt is once again completed with an expansion element and can be reused.

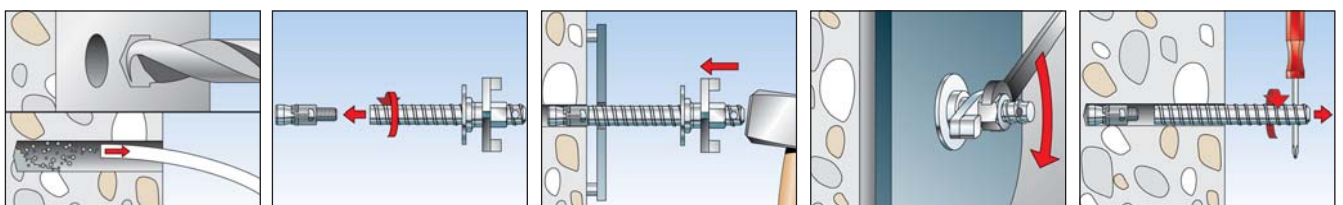

TECHNICAL DATA



Fixing set for diamond drills **FDBB**



Expansion element **FDBB SE**

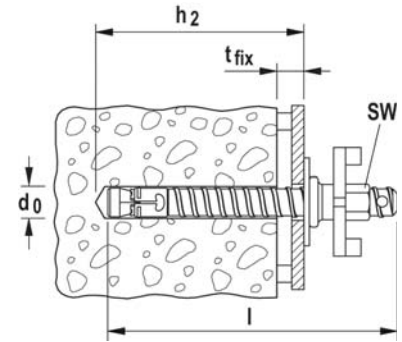

Item	Art.-No.	Drill hole diameter d_0 [mm]	Usable length t_{fix} [mm]	Min. drill hole depth for through fixings h_2 [mm]	Width across nut $\varnothing SW$ [mm]	Length l [mm]	Contents	Sales unit [pcs]
FDBB 16/50 Set	090680	16	50	135	27	200	1 expansion element 16 SE, 1 spindle bolt 16/50/160, 1 washer, 1 nut	1
FDBB 16 SE	090681	16	—	—	—	—	Expansion element	25

LOADS

Fixing set for Diamond Drills FDBB

Highest recommended loads¹⁾ for a single anchor in non-cracked concrete.

Type	Recommended bending moment M_{rec} [Nm]	C20/25		C12/15	
		Recommended Tensile load N_{rec} [kN]	Recommended shear load $V_{rec}^{2)}$ [kN]	Recommended Tensile load N_{rec} [kN]	Recommended shear load $V_{rec}^{2)}$ [kN]
FDBB	98	12,0	13,3	9,0	13,3

¹⁾ Required safety factors are considered.

²⁾ Steel failure value.

The fixing with simple hammer-set installation in non-cracked concrete



Radiators

VERSIONS

- Zinc-plated steel

BUILDING MATERIALS

Suitable for:

- Concrete C12/15 to C50/60, non-cracked
- Natural stone with dense structure

ADVANTAGES

- The special construction of the anchor sleeve enables it to be set into the drill hole with a low number of hammer blows. This enables easy installation.
- The flush-sunk expansion pin signifies the complete expansion of the anchor, and thereby ensures minimum movement when under load.
- The special geometry of the expansion pin reduces the setting energy, thereby enabling a fast and energy-saving installation.

APPLICATIONS

- Non-approval-relevant fixings only
- Handrails
- Gratings
- Garden gates

FUNCTIONING

- The MR is suitable for pre-positioned and push-through installation.
- The anchor sleeve is driven into the drill hole with a hammer, without the need for an expansion pin.
- Then the expansion pin is driven in with a hammer, and the wall screw expands against the drill hole wall.

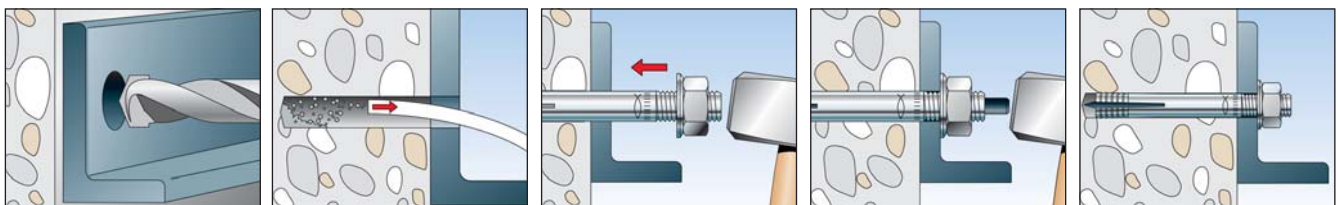

TECHNICAL DATA

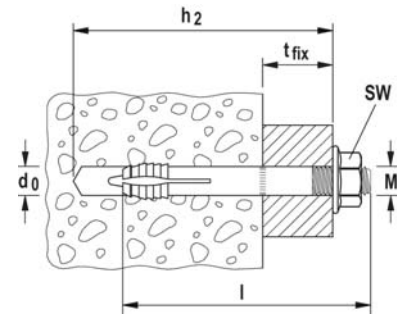

	Zinc-plated steel	Drill hole diameter	Anchor length	Min. drill hole depth for through fixings	Thread	Width across nut	Max. fixture thickness	Sales unit
	Art.-No.	d_0 [mm]	l [mm]	h_2 [mm]	M	\circ SW [mm]	t_{fix} [mm]	[pcs]
Item	gvz							
MR 8	050583	8	70	70	M 8	13	22	25
MR 10	050584	10	85	85	M 10	15	24	20
MR 12	050585	12	100	100	M 12	18	27	10

High performance steel anchors 4

The installation-friendly internally threaded anchor for fixings in pre-stressed hollow-core concrete slabs



Air conditioning units in pre-stressed hollow-core concrete slabs



Cable trays in pre-stressed hollow-core concrete

VERSIONS

- Zinc-plated steel
- Stainless steel

BUILDING MATERIALS

Approved for:

- Pre-stressed hollow-core concrete slabs \geq C45/55

CERTIFICATES



ADVANTAGES

- The active principle of the anchor means that the FHY can be used in cavities or in solid materials up to 5 cm from the tensioning wire. This ensures the highest flexibility and user-friendly installation.
- The embossed edge prevents the anchor sleeve from slipping in the cavity, thus allowing for trouble-free installation.
- The optimised geometry minimises setting energy and allows for use in extremely narrow spaces. This allows for user-friendly installation.
- The metric internal thread means that it is possible to use standard screws or threaded rods for the ideal adaptation to suit the intended use.

APPLICATIONS

- Pipelines
- Cable trays
- Ventilation systems
- Sprinkler systems
- Suspended ceilings
- Consoles
- Steel constructions
- Timber constructions

FUNCTIONING

- The FHY is suitable for pre-positioned installation.
- Position the FHY hollow-ceiling anchor in the drill hole and drive in flush to the surface of the anchor base using the hammer.
- The FHY pre-positioned anchor must be able to be supported on the attachment for expansion.
- When applying the torque, the cone is pulled into the expansion sleeve and expands it into the cavity or expands it in the solid material against the drill hole wall.
- Screw length $l_s =$
 Minimum screw-in depth e_2
 + Thickness of fixture t_{fix}
 + Thickness of washer
 (with threaded rod: + height of nut)

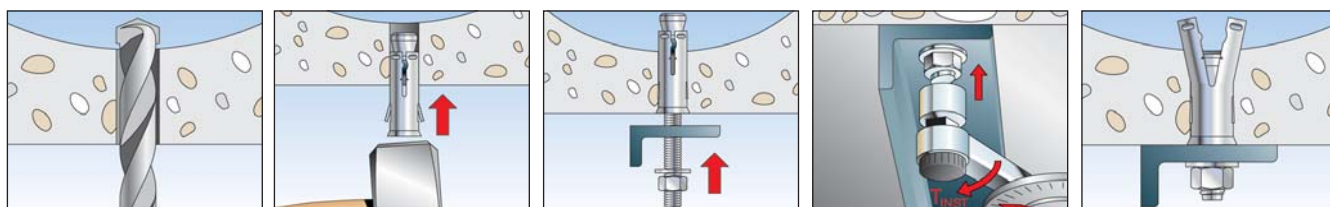

TECHNICAL DATA



Hollow-ceiling anchor **FHY**

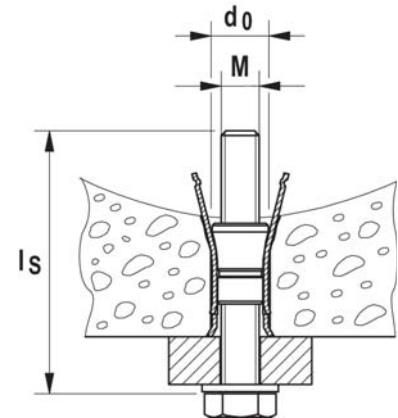

	Zinc-plated steel	Stainless steel	Approval	Drill hole diameter	Anchor length	Thread	Min. drill hole depth	Min. bolt penetration	Sales unit
	Art.-No.	Art.-No.	DIBt	d_0 [mm]	l [mm]	M	h_1 [mm]	$l_{E,min}$ [mm]	[pcs]
Item	gvz	A4							
FHY M 6	030138	—	●	10	37	M 6	50	37	50
FHY M 6	—	030139	—	10	37	M 6	50	37	50
FHY M 8	030146	—	●	12	43	M 8	60	43	25
FHY M 8	—	030147	—	12	43	M 8	60	43	25
FHY M10	030148	—	●	16	52	M 10	65	52	20
FHY M10	—	030151	—	16	52	M 10	65	52	20
FHY M12	545512	—	—	18	52	M 12	65	52	25

LOADS

Hollow-ceiling anchor FHY zinc plated steel

Highest permissible loads¹⁾³⁾ for a single anchor in pre-stressed hollow-core concrete slabs of strength class $\geq C45/55$.

Type	Bottom flange thickness	Installation torque	Permissible load	Required edge distance (with one edge) for max. load	Min. spacing	Min. edge distance		
	d_u [mm]	T_{inst} [Nm]	$F_{perm}^{2)}$ [kN]	[mm]	$s_{min}^{4)}$ [mm]	$c_{min}^{4)}$ [mm]		
FHY M6	25 - 29	10	0,7	150	70	100		
	30 - 39		0,9		80			
	≥ 40		2,0		100			
FHY M8	25 - 29	10	0,7		150		70	100
	30 - 39		0,9				80	
	≥ 40		2,0				100	
FHY M10	30 - 39	20	1,2	150		80	100	
	≥ 40		3,0			100		

For the design the complete approval Z-21.1-1711 has to be considered.

¹⁾ The required safety factors as regulated in the approval are considered.

²⁾ Valid for tensile load, shear load and oblique load under any angle. For combinations of tensile loads, shear loads, bending moments as well as reduced edge distances or spacings (anchor groups) see approval.

³⁾ For screw strength class 4.6.

⁴⁾ Minimum possible axial spacings resp. edge distance while reducing the permissible load.

LOADS

Hollow-ceiling anchor FHY stainless steel A4

Highest recommended loads ^{1) 3)} for a single anchor in pre-stressed hollow-core concrete slabs of strength class \geq C45/55

Type	Bottom flange thickness d_u [mm]	Installation torque T_{inst} [Nm]	Recommended load F_{rec} ²⁾ [kN]	Required edge distance (with one edge) for Max. load [mm]	Min. spacing s_{min} ⁴⁾ [mm]	Min. edge distance c_{min} ⁴⁾ [mm]
FHY M6 A4	25 - 29	10	0,7	150	70	100
	30 - 39		0,9		80	
	≥ 40		2,0		100	
FHY M8 A4	25 - 29	10	0,7		70	
	30 - 39		0,9		80	
	≥ 40		2,0		100	
FHY M10 A4	30 - 39	20	1,2		80	
	≥ 40		3,0		100	

¹⁾ Required safety factors are considered.

²⁾ Valid for tensile load, shear load and oblique load under any angle.

³⁾ For screw strength class A4-70.

⁴⁾ Minimum possible axial spacings resp. edge distance while reducing the permissible load.

The strong internally threaded anchor with unique 4-way expansion for fixings in aerated concrete



Rail fixing



Air conditioning units

High performance steel anchors 4

VERSIONS

- Zinc-plated steel

BUILDING MATERIALS

Approved for:

- Aerated concrete with compressive strength 2 to 7 N/mm²
- Aerated concrete wall or ceiling boards with compressive strength 3.3 to 4.4 N/mm²
- Planked aerated concrete masonry, e.g. plastered, tiled, papered etc.

CERTIFICATES



ADVANTAGES

- The FPX-I enables easy tightening via the hexagon wrench using a cordless screwdriver or ratchet and therefore offers top installation comfort.
- The deformation-controlled expansion of the anchor with the hexagon wrench ensures safe, even and gentle installation.
- The unique 4-way expansion of the FPX-I with a square expansion sleeve prevents the rotation of the anchor in the drill hole and ensures high tension and shear loads, which means fewer fixing points.
- The releasing of the hexagonal wrench guarantees an automatic setting control for each installation process.
- The first steel anchor with an ETA-Approval and fire protection certificate for fixings in aerated concrete enables use for safety-relevant fixings, too.

APPLICATIONS

- Suspended ceilings
- Cable trays
- Pipelines
- Ventilation ducts
- Guard rails/hand rails
- TV consoles
- Kitchen cupboards
- Stand-off installations

FUNCTIONING

- The FPX-I with internal thread is suitable for pre-positioned installation.
- Pre-drilling enables easy hammering in, even in high-strength aerated concrete. There is no need to clean the drill hole.
- When the anchor is tightened with the hexagon wrench, the internal thread sleeve starts to rotate and the cone is pulled into the square expansion sleeve. The aerated concrete is compressed on the four sides and generates an undercut in the drill hole.
- When reached the optimum expansion, the hexagon wrench is released automatically from the anchor.

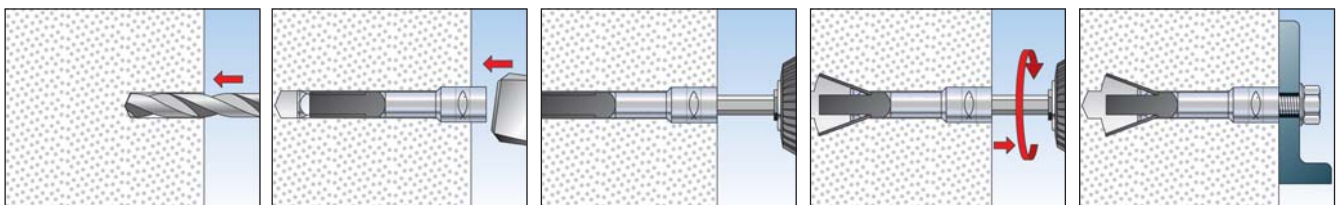

TECHNICAL DATA



Aircrete anchor **FPX-I**

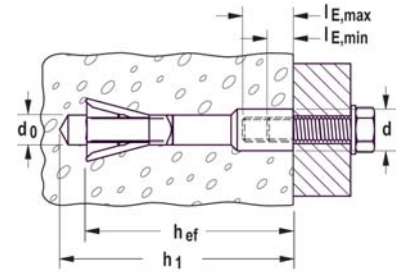

Item	Art.-No.	Approval ETA	Drill diameter d_0 [mm]	Min. drill hole depth for pre-positioned installation h_1 [mm]	Anchor length l [mm]	Effect. anchorage depth h_{ef} [mm]	Min. bolt pene- tration $l_{E,min}$ [mm]	Max. bolt pene- tration $l_{E,max}$ [mm]	Sales unit [pcs]
Item	gvz								
FPX M6-I	519021	■	10	95	75	70	10	15	25
FPX M8-I	519022	■	10	95	75	70	8	15	25
FPX M10-I	519023	■	10	95	75	70	10	15	25
FPX M12-I	519024	■	10	95	75	70	12	15	25

ACCESSORIES



Setting tool **FPX M6 I**



Setting tool **FPX M8-M12 I**

Item	Art.-No.	Matching anchor type	Sales unit [pcs]
Setting tool FPX M6 I	522517	FPX M6-I	10
Setting tool FPX M8-M12 I	522518	FPX M8-I - FPX M12-I	10

LOADS

AAC anchor FPX-I

Highest permissible loads¹⁾⁵⁾ and required component dimensions in aerated concrete masonry.

Type			FPX-I M6 , M8 , M10 , M12	
Permissible load¹⁾⁵⁾ per anchor F_{perm}				
Effective anchoring depth	hef	[mm]	70	
$f_{ck} \geq 1,6 \text{ N/mm}^2 / \rho_m \geq 0,25 \text{ kg/dm}^3$		[kN]	0,32	
$f_{ck} \geq 2,0 \text{ N/mm}^2 / \rho_m \geq 0,35 \text{ kg/dm}^3$		[kN]	0,43	
$f_{ck} \geq 4,0 \text{ N/mm}^2 / \rho_m \geq 0,50 \text{ kg/dm}^3$		[kN]	0,89	
$f_{ck} \geq 6,0 \text{ N/mm}^2 / \rho_m \geq 0,65 \text{ kg/dm}^3$		[kN]	1,43	
Component dimensions				
Minimum member thickness with drill hole cleaning	h _{min}	[mm]	100	
Minimum member thickness without drill hole cleaning	h _{min}	[mm]	120	
Single anchor				
Min. spacing between single anchors	a	[mm]	375	
Min. edge distance	c ₁	[mm]	125	
Min. distance to joints	c _F ⁴⁾	[mm]	75 ²⁾ / 125	
Min. edge distance orthogonal to c ₁	c ₂	[mm]	190	
Anchor groups³⁾ with 2 or 4 Ancors				
Actions			shear + oblique tension	only axial tension
Min. spacing	s _{min}	[mm]	100	100
Min. edge distance	c ₁	[mm]	250	125
Min. spacing between single anchors	a	[mm]	750	375
Min. edge distance orthogonal to c ₁	c ₂	[mm]	375	190

For the design the complete approval ETA - 12/0456 has to be considered.

¹⁾ The required partial safety factors for material resistance as well as a partial safety factor for load actions of $\gamma_L = 1,4$ are considered.

²⁾ c_F for tensile load and/or shear load parallel to the joint which is not filled with mortar with width $\leq 2 \text{ mm}$.

³⁾ $F_{perm,Group} = 2 \times F_{perm,single \text{ anchor}}$ valid in case of anchor groups with 2 or 4 anchors.

⁴⁾ In case of non visible joints F_{perm} has to be divided in half.

⁵⁾ Grade of the screw, resp. threaded rod ≥ 4.8 .

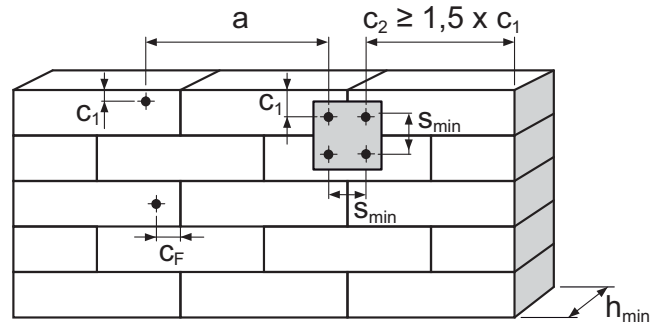

LOADS

AAC anchor FPX-I

Highest permissible loads¹⁾⁴⁾ and required component dimensions in cracked and non-cracked aerated concrete wall and slab plates.

Type			FPX-I M6 , M8 , M10 , M12	
Permissible load¹⁾⁴⁾ per anchor F_{perm}				
Effective anchoring depth	hef	[mm]	70	
Tensile area of the AAC plate				
$f_{ck} \geq 3,3 \text{ N/mm}^2 / \rho_m \geq 0,50 \text{ kg/dm}^3$		[kN]	0,62	
$f_{ck} \geq 4,4 \text{ N/mm}^2 / \rho_m \geq 0,55 \text{ kg/dm}^3$		[kN]	0,83	
Compression area of the AAC plate				
$f_{ck} \geq 3,3 \text{ N/mm}^2 / \rho_m \geq 0,50 \text{ kg/dm}^3$		[kN]	0,83	
$f_{ck} \geq 4,4 \text{ N/mm}^2 / \rho_m \geq 0,55 \text{ kg/dm}^3$		[kN]	1,24	
Component dimensions				
Minimum member thickness with drill hole cleaning	h _{min}	[mm]	100	
Minimum member thickness without drill hole cleaning	h _{min}	[mm]	120	
Single anchor				
Min. spacing between single anchors	a	[mm]	600	
Min. edge distance	c ₁	[mm]	125 / 300 ³⁾	
Min. edge distance orthogonal to c ₁	c ₂	[mm]	190	
Anchor groups²⁾ with 2 or 4 anchors				
Actions			shear + oblique tension	only axial tension
Min. spacing	s _{min}	[mm]	100	100
Min. edge distance	c ₁	[mm]	250	125 / 150 ³⁾
Min. spacing between single anchors	a	[mm]	750	600
Min. edge distance orthogonal to c ₁	c ₂	[mm]	375	190

For the design the complete approval ETA - 12/0456 has to be considered.

¹⁾ The required partial safety factors for material resistance as well as a partial safety factor for load actions of $\gamma_L = 1,4$ are considered.

²⁾ $F_{perm,Group} = 2 \times F_{perm,single\ anchor}$ valid in case of anchor groups with 2 or 4 anchors.





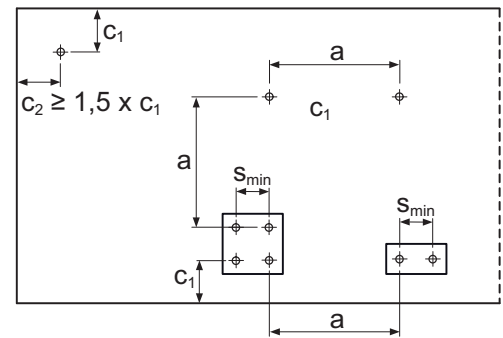











³⁾ In case of reinforced plates with a width ≤ 700 mm.

⁴⁾ Grade of the screw, resp. threaded rod ≥ 4.8 .



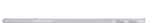

5 Frame fixings / Stand-off installation

		Page
Frame fixing SXRL		294
Frame fixing SXR		300
Frame fixing FUR		306
Anti-corrosion spray FTC-CP		310
Hammerfix N		311
Hammerfix N GREEN		315
Nail sleeve FNH		317
Window frame fixing F-S		319
Metal frame fixing F-M		321
Window frame screws FFSZ and FFS		324
Wall tie VB		328
Adjustable fixing S10J		329
Adjustable screw JUSS		331
Spacing screw ASL		332
Stand-off installation Thermax 8 / 10		334
Stand-off installation Thermax 12 / 16		337
Remedial wall tie mechanical VBS-M		343

The versatile with multiple anchorage depth



Timber substructures



Wall consoles

5 Frame fixings / Stand-off installation

VERSIONS

- Zinc-plated steel
- Stainless steel

BUILDING MATERIALS

Approved for:

- Vertically perforated brick
- Aerated concrete
- Hollow blocks made from lightweight concrete
- Perforated sand-lime brick
- Thermal insulation blocks
- Solid block made from lightweight and normal weight concrete
- Solid brick
- Solid sand-lime brick
- Concrete \geq C12/15

Also suitable for:

- Natural stone with dense structure
- Solid panel made from gypsum

CERTIFICATES



ADVANTAGES

- The long expansion element with multiple anchorage depths of 50, 70 or 90 mm for SXRL 8 and SXRL 10 and 70 or 90 mm for SXRL 14 makes the SXRL a versatile applicable product.
- Through the special geometry of the plug, the loads are evenly distributed in the drill hole.
- When the plug is to be set below the plaster, the longer ribs prevent plug rotation during installation.
- The approval for single-point fixing in cracked concrete makes the SXRL the designated specialist in concrete particularly for tasks such as the installation of awning roofs and outdoor railings compared to steel anchors.
- SXRL 14 is approved for the application under compression load and is thus for example useable for facade substructures that are mounted at a distance without wall brackets.
- Complete range available with diameters of 8, 10 and 14 mm and usable lengths up to 290 mm.

APPLICATIONS

- Façade, ceiling and roof substructures made of wood and metal
- Façade substructures under compression load (e.g. distance installation without a wall bracket)
- Windows
- Gates and doors
- Wardrobes
- Kitchen hanging cabinets
- Squared timbers
- Beams
- TV consoles
- Wall covering
- Metal brackets
- Metal supports
- Cable ducts
- Cable trays

FUNCTIONING

- In hollow building materials, the two expansion zones ensure that the introduction of force is gentle on the substrate. The porous block fillets are not crushed by the second expansion zone and therefore serve to transmit the force
- In aircrete and solid building material, the two expansion zones combine to form one long expansion element, thus providing for a uniform and flat distribution of the load into substrate.
- SXRL-T with countersunk head screw is recommended for the installation of timber constructions; in the case of metal constructions, use SXRL-FUS with a wide sleeve rim and a moulded washer on the screw, which also features an integrated hexagon socket.

INSTALLATION

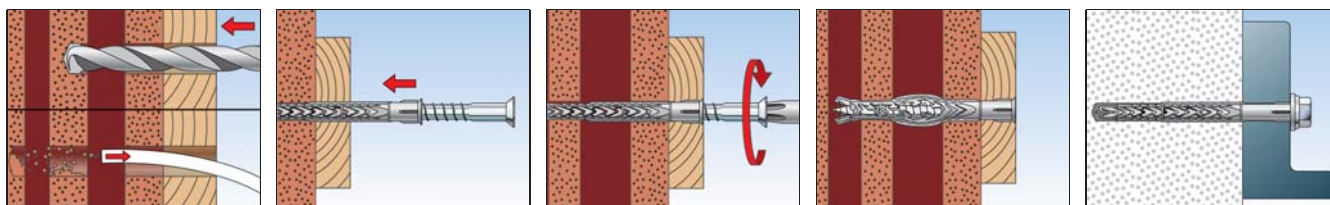

TECHNICAL DATA



SXRL-T - with fischer countersunk head safety screw

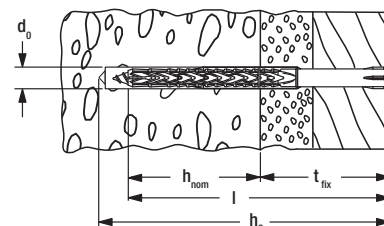

Item	Zinc-plated steel	Stainless steel	Approval		Drill diameter	Min. drill hole depth for through fixings	Usable length at anchorage depth 50mm	Usable length at anchorage depth 70mm	Usable length at anchorage depth 90mm	Anchor length	Drive	Sales unit
	Art.-No.	Art.-No.	ETA	DIBt	d_0 [mm]	h_2 [mm]	l_{fix} [mm]	l_{fix} [mm]	l_{fix} [mm]	l [mm]		[pcs]
	gvz	A4										
SXRL 8 x 60 T	540113	540119	■	—	8	70	10	—	—	60	T30	50
SXRL 8 x 80 T	540114	540121	■	—	8	90	30	10	—	80	T30	50
SXRL 8 x 100 T	540115	540123	■	—	8	110	50	30	10	100	T30	50
SXRL 8 x 120 T	540116	540124	■	—	8	130	70	50	30	120	T30	50
SXRL 8 x 140 T	540117	540125	■	—	8	150	90	70	50	140	T30	50
SXRL 8 x 160 T	540118	540126	■	—	8	170	110	90	70	160	T30	50
SXRL 10 x 60 T	546477	546505	■	●	10	70	10	—	—	60	T40	50
SXRL 10 x 80 T	522698	522709	■	●	10	90	30	10	—	80	T40	50
SXRL 10 x 100 T	522699	522710	■	●	10	110	50	30	10	100	T40	50
SXRL 10 x 120 T	522700	522711	■	●	10	130	70	50	30	120	T40	50
SXRL 10 x 140 T	522701	522712	■	●	10	150	90	70	50	140	T40	50
SXRL 10 x 160 T	522703	522713	■	●	10	170	110	90	70	160	T40	50
SXRL 10 x 180 T	522704	522714	■	●	10	190	130	110	90	180	T40	50
SXRL 10 x 200 T	522705	522715	■	●	10	210	150	130	110	200	T40	50
SXRL 10 x 230 T	522706	522716	■	●	10	240	180	160	140	230	T40	50
SXRL 10 x 260 T	522707 ¹⁾	522717 ¹⁾	■	●	10	270	210	190	170	260	T40	50
SXRL 10 x 290 T	522708 ¹⁾	522718 ¹⁾	■	●	10	300	240	220	200	290	T40	50
SXRL 14 x 80 T	530920	530932	■	●	14	95	—	10	—	80	T50	50
SXRL 14 x 100 T	530921	530933	■	●	14	115	—	30	10	100	T50	50
SXRL 14 x 120 T	530922	530934	■	●	14	135	—	50	30	120	T50	50
SXRL 14 x 140 T	530923	530935	■	●	14	155	—	70	50	140	T50	50
SXRL 14 x 160 T	530924	530936	■	●	14	175	—	90	70	160	T50	50
SXRL 14 x 180 T	530925	530937	■	●	14	195	—	110	90	180	T50	50
SXRL 14 x 200 T	530926	530938	■	●	14	215	—	130	110	200	T50	50
SXRL 14 x 230 T	530927	530939	■	●	14	245	—	160	140	230	T50	50
SXRL 14 x 260 T	530928	530940	■	●	14	275	—	190	170	260	T50	50
SXRL 14 x 300 T	530929 ¹⁾	530941 ¹⁾	■	●	14	315	—	230	210	300	T50	20
SXRL 14 x 330 T	530930 ¹⁾	530942 ¹⁾	■	●	14	345	—	260	240	330	T50	20
SXRL 14 x 360 T	530931 ¹⁾	530943 ¹⁾	■	●	14	375	—	290	270	360	T50	20

1) not pre-assembled

TECHNICAL DATA



SXRL-FUS - with fischer hexagon head safety screw, moulded washer and integrated bit recess

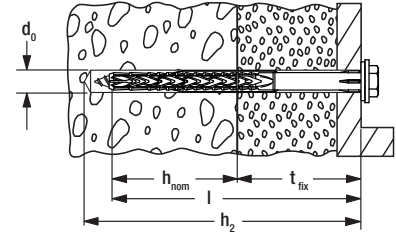

5
Frame fixings / Stand-off installation

Item	Zinc-plated steel	Stainless steel	Approval		Drill diameter	Min. drill hole depth for through fixings	Usable length at anchorage depth 50mm	Usable length at anchorage depth 70mm	Usable length at anchorage depth 90mm	Anchor length	Drive	Sales unit
	Art.-No.	Art.-No.	ETA	DIBt	d_0 [mm]	h_2 [mm]	t_{fix} [mm]	t_{fix} [mm]	t_{fix} [mm]	l [mm]		[pcs]
	gvs	A4										
SXRL 8 x 60 FUS	540127	540135	■	—	8	70	10	—	—	60	T30/SW10	50
SXRL 8 x 80 FUS	540129	540136	■	—	8	90	30	10	—	80	T30/SW10	50
SXRL 8 x 100 FUS	540130	540137	■	—	8	110	50	30	10	100	T30/SW10	50
SXRL 8 x 120 FUS	540131	—	■	—	8	130	70	50	30	120	T30/SW10	50
SXRL 8 x 140 FUS	540133	—	■	—	8	150	90	70	50	140	T30/SW10	50
SXRL 8 x 160 FUS	540134	—	■	—	8	170	110	90	70	160	T30/SW10	50
SXRL 10 x 60 FUS	546506	546507	■	●	10	70	10	—	—	60	T40/SW13	50
SXRL 10 x 80 FUS	522719	522730	■	●	10	90	30	10	—	80	T40/SW13	50
SXRL 10 x 100 FUS	522720	522731	■	●	10	110	50	30	10	100	T40/SW13	50
SXRL 10 x 120 FUS	522721	522732	■	●	10	130	70	50	30	120	T40/SW13	50
SXRL 10 x 140 FUS	522723	522733	■	●	10	150	90	70	50	140	T40/SW13	50
SXRL 10 x 160 FUS	522724	522734	■	●	10	170	110	90	70	160	T40/SW13	50
SXRL 10 x 180 FUS	522725	522735	■	●	10	190	130	110	90	180	T40/SW13	50
SXRL 10 x 200 FUS	522726	522736	■	●	10	210	150	130	110	200	T40/SW13	50
SXRL 10 x 230 FUS	522727	522737	■	●	10	240	180	160	140	230	T40/SW13	50
SXRL 10 x 260 FUS	522728 1)	522738 1)	■	●	10	270	210	190	170	260	T40/SW13	50
SXRL 10 x 290 FUS	522729 1)	522739 1)	■	●	10	300	240	220	200	290	T40/SW13	50
SXRL 14 x 80 FUS	530946	530955	■	●	14	95	—	10	—	80	T50/SW17	50
SXRL 14 x 100 FUS	530947	530956	■	●	14	115	—	30	10	100	T50/SW17	50
SXRL 14 x 120 FUS	530948	530957	■	●	14	135	—	50	30	120	T50/SW17	50
SXRL 14 x 140 FUS	530949	530958	■	●	14	155	—	70	50	140	T50/SW17	50
SXRL 14 x 160 FUS	530950	530959	■	●	14	175	—	90	70	160	T50/SW17	50
SXRL 14 x 180 FUS	530951	530960	■	●	14	195	—	110	90	180	T50/SW17	50
SXRL 14 x 200 FUS	530952	530961	■	●	14	215	—	130	110	200	T50/SW17	50
SXRL 14 x 230 FUS	530953	530962	■	●	14	245	—	160	140	230	T50/SW17	50
SXRL 14 x 260 FUS	530954	530963	■	●	14	275	—	190	170	260	T50/SW17	50

1) not pre-assembled

ACCESSORIES



SXRL - without screw

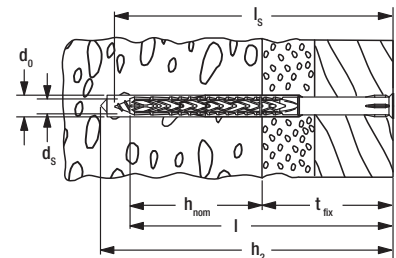

Item	Art.-No.	Drill diameter	Min. drill hole depth for through fixings	Usable length at anchorage depth 50mm	Usable length at anchorage depth 70mm	Usable length at anchorage depth 90mm	Anchor length	Screw diameter	Min. screw length	Sales unit
		d_0 [mm]	h_2 [mm]	t_{fix} [mm]	t_{fix} [mm]	t_{fix} [mm]	l [mm]	d_s [mm]	l_s [mm]	[pcs]
SXRL 8 x 60	540879	8	70	10	—	—	60	5,5 - 6,0	65	100
SXRL 8 x 80	540880	8	90	30	10	—	80	5,5 - 6,0	85	100
SXRL 8 x 100	540881	8	110	50	30	10	100	5,5 - 6,0	105	100
SXRL 8 x 120	540882	8	130	70	50	30	120	5,5 - 6,0	125	100

ACCESSORIES



Cover cap ADT

Item	Art.-No.	Colour	Cap [Ø mm]	Match	Sales unit [pcs]
ADT 15 W	060326	white	15	Safety screw with integrated bit recess T40	100
ADT 15 DB	060329	dark brown	15	Safety screw with integrated bit recess T40	100
ADT 18 W	060334	white	18	Safety screw with integrated bit recess T40	100
ADT 18 DB	060337	dark brown	18	Safety screw with integrated bit recess T40	100

ACCESSORIES



Washer U

Item	Art.-No.	External-Ø d [mm]	Hole-Ø D [mm]	Thickness S [mm]	Matching anchor type	Sales unit [pcs]
U 11,5 x 21 x 1,5 DIN 522 A2	010026	21	11.5	1.5	SXR 10, SXRL 10, FUR 10	500

LOADS

Frame fixing SXRL³⁾

Highest recommended loads¹⁾ for a single anchor as part of a multiple fixing of non-structural systems.
The given loads are valid for wood screws with the specified diameter.

Type	SXRL 8				
Anchorage depth	h_{nom} [mm]	50	70	90	
Screw diameter	\emptyset [mm]	6,0	6,0	6,0	
Min. edge distance concrete	a_r [mm]	60	80	100	
Recommended loads in the respective base material F_{rec}²⁾					
Concrete	\geq C20/25 [kN]	0,60	1,00	1,00	
Solid brick	\geq Mz 12 [kN]	0,45	0,60	0,60	
Solid sand-lime brick	\geq KS 12 [kN]	0,40	0,50	0,50	
Vertically perforated brick	\geq Hlz 12 ($\rho \geq 1,0 \text{ kg/dm}^3$) [kN]	0,15	0,15	0,15	
Perforated sand-lime brick	\geq KSL 12 [kN]	0,10	0,40	0,40	
Aerated concrete	AAC 2 [kN]	-	0,10	0,10	
Aerated concrete	AAC 4 [kN]	-	0,15	0,20	

¹⁾ Required safety factors are considered.

²⁾ Valid for tensile load, shear load and oblique load under any angle.

³⁾ Valid for zinc coated screws and for screws made of stainless steel. For exterior use of the zinc coated screws measures against incoming humidity have to be taken.

LOADS

Frame fixing SXRL⁴⁾

Highest permissible loads¹⁾²⁾ of a single anchor as part of a multiple fixing of non-structural systems. For the design the complete assessment ETA-07/0121 has to be considered.

Product		SXRL									
Anchor diameter	[mm]	Ø 8			Ø 10			Ø 14			
Anchorage depth	h_{nom} [mm]	50	70	90	50	70	90	70	90		
Anchorage in concrete \geq C12/15											
Permissible tensile load	[kN]	1,59	1,98		1,98	2,58		3,37			
Permissible shear load	Zinc-plated steel [kN]	4,23			5,98			12,40			
	Stainless steel A4 [kN]	3,93			5,98			11,63			
Minimum member thickness	h_{min} [mm]	80	100	120	100		120	110	130		
Characteristic edge distance	$c_{cr,N}$ [mm]	85			140			140			
Characteristic spacing	a resp. $s_{cr,N}$ [mm]	90	105		120			135			
Minimum spacing with an edge distance	s_{min} [mm]	85			70			85			
	$c \geq$ [mm]	85			140			140			
Minimum edge distance with a spacing	c_{min} [mm]	85			70			85			
	$s \geq$ [mm]	85			175			175			
Anchorage in narrow concrete members ($h \geq 40$ mm) made of concrete \geq C12/15, e.g. weather shells of triple-skin outer wall panels											
Permissible tensile load	[kN]	-			0,99	-		-			
Permissible shear load	[kN]	-			5,98	-		-			
Anchorage in pre-stressed hollow-core concrete slabs (mirror thickness $d_b \geq 30$ mm) made of concrete \geq C45/55											
Permissible tensile load	[kN]	-			1,39	-		-			
Permissible shear load	[kN]	-			5,98	-		-			
Anchorage in masonry											
Permissible load ³⁾ in solid brick	\geq Mz 12 a. \geq NF [kN]	0,57	0,71		0,57	1,14	-		0,86		
	\geq Mz 20 a. \geq NF [kN]	0,86	1,14		1,00	1,14	-		1,14		
Permissible load ³⁾ in solid sand-lime brick	\geq KS 10 a. \geq NF [kN]	0,57			0,57	0,71	-		0,86		
	\geq KS 20 a. \geq NF [kN]	0,71	0,86		1,00		-		1,29		
Permissible load ³⁾ in lightweight concrete block	\geq V 2; $\rho \geq 1,2$ kg/dm ³ [kN]	0,11	0,26		0,11		-		0,26		
	\geq V 6; $\rho \geq 1,6$ kg/dm ³ [kN]	0,34	0,57		0,57	1,29	-		0,57		
Permissible load ³⁾⁵⁾ in vertically perforated brick (e.g. Poroton)	\geq HLz 10; $\rho \geq 1,0$ kg/dm ³ [kN]	0,17			-	0,21	-		0,57	0,71	
Permissible load ³⁾ in perforated sand-lime brick	\geq KSL 6 [kN]	-			-	0,21	-		0,26	0,34	
	\geq KSL 12 [kN]	0,34	0,43		-	0,71	-		0,43	0,71	
Permissible load in ³⁾⁵⁾ hollow lightweight concrete blocks	\geq HBL 2 [kN]	0,43	0,57	0,43	0,57	0,71	-		0,34	0,21	
	\geq HBL 6 [kN]	0,43	0,71	0,43	0,71	0,43	-		0,57	-	
Permissible load ³⁾⁵⁾ in ceilings made of vertically perforated bricks	$f_b \geq 10$ N/mm ² ; $\rho \geq 0,7$ kg/dm ³ [kN]	-			-	0,57	-		-		
Minimum member thickness	h_{min} [mm]	115			110			115			
Minimum spacing (single anchor)	a_{min} [mm]	250			250			250			
Minimum spacing (anchor group)	s_{min} [mm]	100			100			100			
Minimum edge distance (anchor group)	c_{min} [mm]	100			100			100			
Anchorage in aerated concrete											
Permissible load ³⁾ in aerated concrete	2 N/mm ² [kN]	-	0,14	0,21	-	0,18	0,21	0,32	0,43		
	4 N/mm ² [kN]	-	0,32	0,43	-	0,43	0,54	0,89	1,07		
	6 N/mm ² [kN]	-	0,54	0,71	-	0,71	0,89	1,43	1,79		
Minimum member thickness	h_{min} [mm]	-	175		-	100	120	175 ⁶⁾ /300 ⁷⁾			
Minimum spacing (single anchor)	a_{min} [mm]	-	250		-	250		250			
Minimum spacing (anchor group)	s_{min} [mm]	-	80 ⁶⁾ /110 ⁸⁾		-	100 ⁶⁾ /120 ⁶⁾		80	100 ⁶⁾ /125 ⁷⁾		
Minimum edge distance (anchor group)	c_{min} [mm]	-	90 ⁶⁾ /110 ⁸⁾		-	120		120	120 ⁶⁾ /150 ⁷⁾		

¹⁾ The required partial safety factors for material resistance as well as a partial safety factor for load actions $\gamma_L = 1,4$ are considered.

As a single anchor counts e.g. an anchor with a minimum spacing a according to table B4.1 resp. table B4.2 of the assessment.

²⁾ Valid for temperatures in the substrate up to +50 °C (resp. short term up to +80 °C). For long term temperatures up to +30 °C higher permissible loads may be possible.

³⁾ Valid for tensile load, shear load and oblique load under any angle. For combinations of tensile loads, shear loads and bending moments see assessment.

⁴⁾ Valid for zinc coated screws and for screws made of stainless steel. For exterior use of the zinc coated screws measures against incoming humidity according to assessment have to be taken.

⁵⁾ Rotary drilling.

⁶⁾ Only valid for AAC with compression strength ≥ 2 to < 4 N/mm².

⁷⁾ Only valid for AAC with compression strength ≥ 4 N/mm².

⁸⁾ Only valid for AAC with compression strength ≥ 6 N/mm².

LOADS

Frame fixing SXRL³⁾

Highest permissible compression loads¹⁾²⁾ of a single anchor as part of a multiple fixing of non-structural systems.

For the design the complete approval Z-2 1.2-2037 has to be considered.

Product			SXRL	
Anchor diameter		[mm]	Ø 14	
Anchorage depth	h_{nom}	[mm]	70	90
Anchorage in concrete \geq C12/15				
Permissible compression load		[kN]	3,37	
Minimum member thickness	h_{min}	[mm]	110	130
Characteristic edge distance	$c_{cr,N}$	[mm]	140	
Characteristic spacing	a resp. $s_{cr,N}$	[mm]	135	
Minimum spacing	s_{min}	[mm]	85	
with an edge distance	$c \geq$	[mm]	140	
Minimum edge distance	c_{min}	[mm]	85	
with a spacing	$s \geq$	[mm]	175	
Anchorage in masonry				
Permissible compression load in solid brick	\geq Mz 12 a. \geq NF	[kN]	0,86	
	\geq Mz 20 a. \geq NF	[kN]	1,14	
Permissible compression load in solid sand-lime brick	\geq KS 10 a. \geq NF	[kN]	0,86	
	\geq KS 20 a. \geq NF	[kN]	1,29	
Permissible compression load in lightweight concrete block	\geq V 2; $\rho \geq 1,2 \text{ kg/dm}^3$	[kN]	0,26	0,34
	\geq V 6; $\rho \geq 1,6 \text{ kg/dm}^3$	[kN]	0,57	
Permissible compression load ⁴⁾ in vertically perforated brick (e.g. Poroton)	\geq HLz 10; $\rho \geq 1,0 \text{ kg/dm}^3$	[kN]	0,34	0,57
Permissible compression load in perforated sand-lime brick	\geq KSL 6	[kN]	0,21	0,34
	\geq KSL 12	[kN]	0,43	0,71
Permissible compression load ⁴⁾ in hollow lightweight concrete blocks	\geq HBL 2	[kN]	0,26	-
Minimum member thickness	h_{min}	[mm]	115	
Minimum spacing (single anchor)	a_{min}	[mm]	250	
Minimum spacing (anchor group)	s_{min}	[mm]	100	
Minimum edge distance (anchor group)	c_{min}	[mm]	100	
Anchorage in aerated concrete				
Permissible compression load in aerated concrete	2 N/mm ²	[kN]	0,32	
	4 N/mm ²	[kN]	0,89	1,07
	6 N/mm ²	[kN]	1,43	1,79
Minimum member thickness	h_{min}	[mm]	175 ⁵⁾ /300 ⁶⁾	
Minimum spacing (single anchor)	a_{min}	[mm]	250	
Minimum spacing (anchor group)	s_{min}	[mm]	80	100 ⁵⁾ /125 ⁶⁾
Minimum edge distance (anchor group)	c_{min}	[mm]	120	120 ⁵⁾ /150 ⁶⁾

¹⁾ The required partial safety factors for material resistance as well as a partial safety factor for load actions $\gamma_L = 1,4$ are considered.
As a single anchor counts e.g. an anchor with a minimum spacing according to tables B3.1, B4.1 resp. B4.2 of the ETA-07/0121.

²⁾ Valid for temperatures in the substrate up to +50 °C (resp. short term up to +80 °C). For long term temperatures up to +30 °C higher permissible loads may be possible.

³⁾ Valid for zinc coated screws and for screws made of stainless steel. For exterior use of the zinc coated screws measures against incoming humidity according to assessment have to be taken.

⁴⁾ Rotary drilling.

⁵⁾ Only valid for AAC with compression strength ≥ 2 to $< 4 \text{ N/mm}^2$.

⁶⁾ Only valid for AAC with compression strength $\geq 4 \text{ N/mm}^2$.

The efficient with short expansion element



5 Frame fixings / Stand-off installation

VERSIONS

- Zinc-plated steel
- Stainless steel
- Hot-dip galvanised steel

BUILDING MATERIALS

- Approved for:**
- Concrete \geq C12/15
 - Vertically perforated brick
 - Hollow blocks made from lightweight concrete
 - Perforated sand-lime brick
 - Solid sand-lime brick
 - Aerated concrete
 - Solid block made from lightweight and normal weight concrete
 - Solid brick
 - Thermal insulation blocks
- Also suitable for:**
- Natural stone with dense structure
 - Solid panel made from gypsum

CERTIFICATES



ADVANTAGES

- The special functioning allows for use in solid and hollow building materials with an anchorage depth of just 50 mm, ensuring an economical fixing.
- The ETA assessment covers use in a range of solid and hollow building materials, and guarantees a secure fixing.
- The specially developed combination of plugs and screws ensures the very best handling. The plug has a noticeable hold, making installation more convenient.
- The extensive range with diameters of 6, 8 and 10 mm, usable lengths up to 210 mm.

APPLICATIONS

- Façade, ceiling and roof substructures made of wood and metal
- Windows
- Gates and doors
- Wardrobes
- Kitchen hanging cabinets
- Squared timbers
- Beams
- TV consoles
- Wall covering
- Metal brackets
- Metal supports
- Cable ducts
- Cable trays

FUNCTIONING

- The SXR is suitable for push-through installation.
- The SXR expands in solid building materials. In hollow building materials the loads are transmitted to the substrate webs.
- With vertically perforated bricks, only use rotary drilling (no impact drilling).
- SXR-T with countersunk head screw is recommended for the installation of timber constructions; in the case of metal constructions, use SXR-FUS with a wide sleeve rim and a moulded washer on the screw, which also features an integrated hexagon socket.

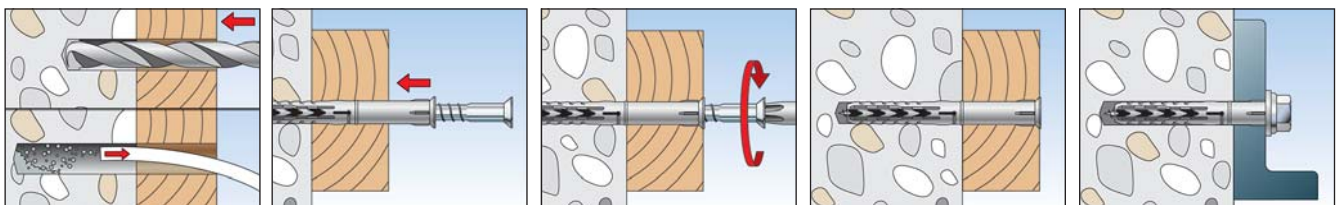

TECHNICAL DATA



SXR - without screw

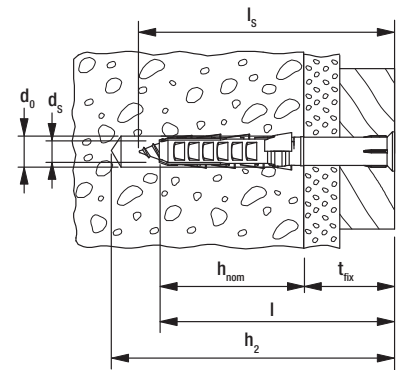

Item	Art.-No.	Drill hole diameter d_0 [mm]	Min. drill hole depth for through fixings h_2 [mm]	Min. anchorage depth h_{nom} [mm]	Anchor length l [mm]	Screw diameter d_s [mm]	Min. screw length l_s [mm]	Max. fixture thickness t_{fix} [mm]	Sales unit [pcs]
SXR 6 x 35	503228	6	45	30	35	4,5	40	5	100
SXR 6 x 50	503229	6	60	30	50	4,5	55	20	100
SXR 6 x 60	503230	6	70	30	60	4,5	65	30	100
SXR 8 x 60	506194	8	70	50	60	5,5 - 6,0	65	10	100
SXR 8 x 80	506196	8	90	50	80	5,5 - 6,0	85	30	100
SXR 8 x 100	506198	8	110	50	100	5,5 - 6,0	125	50	100
SXR 8 x 120	506199	8	130	50	120	5,5 - 6,0	105	70	100

TECHNICAL DATA



SXR-Z - with zinc-plated countersunk head screw with cross drive PZ

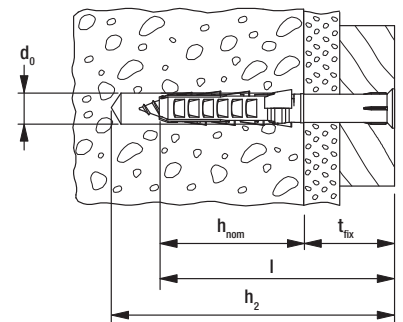

Item	Art.-No.	Drill hole diameter d_0 [mm]	Min. drill hole depth for through fixings h_2 [mm]	Min. anchorage depth h_{nom} [mm]	Anchor length l [mm]	Max. fixture thickness t_{fix} [mm]	Drive	Sales unit [pcs]
SXR 6 x 60 Z	503233 ¹⁾	6	70	30	60	30	PZ2	50

1) not pre-assembled

TECHNICAL DATA



SXR-T - with fischer countersunk head safety screw

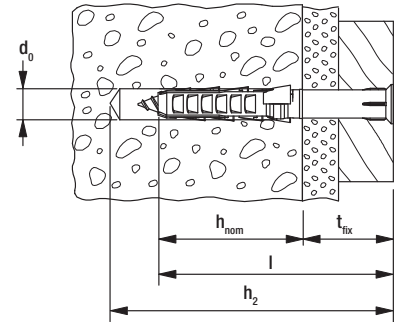

5
Frame fixings / Stand-off installation

	Zinc-plated steel	Stainless steel	Hot-dip galvanised steel	Approval	Drill hole diameter	Min. drill hole depth for through fixings	Min. anchorage depth	Anchor length	Max. fixture thickness	Drive	Sales unit
	Art.-No.	Art.-No.	Art.-No.	ETA	d_0 [mm]	h_2 [mm]	h_{nom} [mm]	l [mm]	t_{fix} [mm]		[pcs]
Item	gvz	A4	hdg								
SXR 8 x 60 T	502999	—	—	■	8	70	50	60	10	T30	50
SXR 8 x 80 T	503000	—	—	■	8	90	50	80	30	T30	50
SXR 8 x 100 T	503001	—	—	■	8	110	50	100	50	T30	50
SXR 8 x 120 T	503002	—	—	■	8	130	50	120	70	T30	50
SXR 10 x 80 T	046263	046272	—	■	10	90	50	80	30	T40	50
SXR 10 x 100 T	046264	046274	—	■	10	110	50	100	50	T40	50
SXR 10 x 100 T	—	—	509534	—	10	110	50	100	50	T40	50
SXR 10 x 120 T	046265	046278	—	■	10	130	50	120	70	T40	50
SXR 10 x 120 T	—	—	509535	—	10	130	50	120	70	T40	50
SXR 10 x 140 T	046266	046279	—	■	10	150	50	140	90	T40	50
SXR 10 x 140 T	—	—	509536	—	10	150	50	140	90	T40	50
SXR 10 x 160 T	046267	046283	—	■	10	170	50	160	110	T40	50
SXR 10 x 180 T	046268	046285	—	■	10	190	50	180	130	T40	50
SXR 10 x 200 T	046269	046286	—	■	10	210	50	200	150	T40	50
SXR 10 x 230 T	046270	046287	—	■	10	240	50	230	180	T40	50
SXR 10 x 260 T	046271	046288	—	■	10	270	50	260	210	T40	50

TECHNICAL DATA



SXR-FUS - with fischer hexagon head safety screw, moulded washer and integrated T40 bit recess

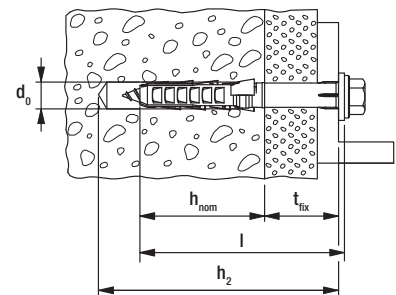

	Zinc-plated steel	Stainless steel	Hot-dip galvanised steel	Approval	Drill hole diameter	Min. drill hole depth for through fixings	Min. anchorage depth	Anchor length	Max. fixture thickness	Drive	Sales unit
	Art.-No.	Art.-No.	Art.-No.	ETA	d_0 [mm]	h_2 [mm]	h_{nom} [mm]	l [mm]	t_{fix} [mm]		[pcs]
Item	gvz	A4	hdg								
SXR 10 x 52 FUS	502456 ¹⁾	—	—	■	10	62	50	52	2	T40/SW13	50
SXR 10 x 60 FUS	046329	046339	—	■	10	70	50	60	10	T40/SW13	50
SXR 10 x 60 FUS	—	—	509537	—	10	70	50	60	10	T40/SW13	50
SXR 10 x 80 FUS	046330	046340	—	■	10	90	50	80	30	T40/SW13	50
SXR 10 x 80 FUS	—	—	509538	—	10	90	50	80	30	T40/SW13	50
SXR 10 x 100 FUS	046331	046342	—	■	10	110	50	100	50	T40/SW13	50
SXR 10 x 100 FUS	—	—	509539	—	10	110	50	100	50	T40/SW13	50
SXR 10 x 120 FUS	046332	046343	—	■	10	130	50	120	70	T40/SW13	50
SXR 10 x 140 FUS	046333	046344	—	■	10	150	50	140	90	T40/SW13	50
SXR 10 x 140 FUS	—	—	509540	—	10	150	50	140	90	T40/SW13	50

1) not pre-assembled

TECHNICAL DATA



SXR-FUS - with fischer hexagon head safety screw, moulded washer and integrated T40 bit recess

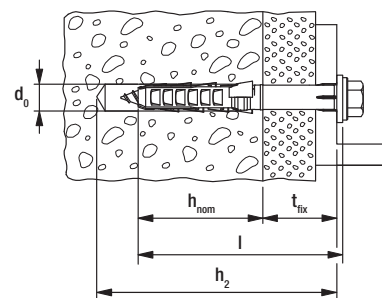

	Zinc-plated steel	Stainless steel	Hot-dip galvanized steel	Approval	Drill hole diameter	Min. drill hole depth for through fixings	Min. anchorage depth	Anchor length	Max. fixture thickness	Drive	Sales unit
	Art.-No.	Art.-No.	Art.-No.	ETA	d_0 [mm]	h_2 [mm]	h_{nom} [mm]	l [mm]	t_{fix} [mm]		[pcs]
Item	gvz	A4	hdg								
SXR 10 x 160 FUS	046334	046345	—	■	10	170	50	160	110	T40/SW13	50
SXR 10 x 180 FUS	046335	046361	—	■	10	190	50	180	130	T40/SW13	50
SXR 10 x 200 FUS	046336	046362	—	■	10	210	50	200	150	T40/SW13	50
SXR 10 x 230 FUS	046337	046363	—	■	10	240	50	230	180	T40/SW13	50
SXR 10 x 260 FUS	046338	046364	—	■	10	270	50	260	210	T40/SW13	50

1) not pre-assembled

ACCESSORIES



Cover cap **ADT**

Item	Art.-No.	Colour	Cap	Match	Sales unit
			[Ø mm]		[pcs]
ADT 15 W	060326	white	15	Safety screw with integrated bit recess T40	100
ADT 15 DB	060329	dark brown	15	Safety screw with integrated bit recess T40	100
ADT 18 W	060334	white	18	Safety screw with integrated bit recess T40	100
ADT 18 DB	060337	dark brown	18	Safety screw with integrated bit recess T40	100

ACCESSORIES



Washer **U**

Item	Art.-No.	External-Ø	Hole-Ø	Thickness	Matching anchor type	Sales unit
		d [mm]	D [mm]	S [mm]		[pcs]
U 11,5 x 21 x 1,5 DIN 522 A2	010026	21	11.5	1.5	SXR 10, SXRL 10, FUR 10	500

ACCESSORIES



Aircrete hole punch **GBS**

Item	Art.-No.	Drill hole	Min. drill hole depth for through fixings	Match	Sales unit
		d_0 [Ø mm]	h_2 [mm]		[pcs]
GBS 10 x 80	050590 1)	9	85	SXR 10 x 52, SXR 10 x 60, SXR 10 x 80	1
GBS 10 x 100	050591 1)	9	105	SXR 10 x 100	1
GBS 10 x 135	050593 1)	9	140	SXR 10 x 120	1
GBS 10 x 160	050594 1)	9	165	SXR 10 x 140, SXR 10 x 160	1
GBS 10 x 185	050595 1)	9	190	SXR 10 x 180	1
GBS 10 x 230	050596 1)	9	235	SXR 10 x 200, SXR 10 x 230	1

1) According to the ETA, the aircrete hole punch GBS must be used for drill-hole production in aerated concrete PB < 4N/mm².

LOADS

Frame fixing SXR⁴⁾

Highest permissible loads¹⁾²⁾ of a single anchor as part of a multiple fixing of non-structural systems.
For the design the complete assessment ETA-07/0121 has to be considered.

Product		SXR		
Anchor diameter		[mm]	Ø 8	Ø 10
Anchorage depth	h_{nom}	[mm]	50	50
Anchorage in concrete \geq C12/15				
Permissible tensile load		[kN]	0,99	1,79
Permissible shear load	Zinc-plated steel	[kN]	4,23	5,98
	Stainless steel A4	[kN]	3,93	5,98
Minimum member thickness	h_{min}	[mm]	100	100
Characteristic edge distance	$c_{cr,N}$	[mm]	70	140
Characteristic spacing	a resp. $s_{cr,N}$	[mm]	70	100
Minimum spacing	s_{min}	[mm]	70	70
with an edge distance	$c \geq$	[mm]	70	210
Minimum edge distance	c_{min}	[mm]	70	85
with a spacing	$s \geq$	[mm]	70	100
Anchorage in narrow concrete members ($h \geq 40$ mm) made of concrete \geq C12/15, e.g. weather shells of triple-skin outer wall panels				
Permissible tensile load		[kN]	-	1,19
Permissible shear load		[kN]	-	5,98
Anchorage in masonry				
Permissible load ³⁾ in solid brick	\geq Mz 12 a. \geq NF	[kN]	0,57	0,57
	\geq Mz 20 a. \geq NF	[kN]	0,71	0,86
Permissible load ³⁾ in solid sand-lime brick	\geq KS 10 a. \geq NF	[kN]	0,57	0,57
	\geq KS 20 a. \geq NF	[kN]	0,71	0,71
Permissible load ³⁾ in lightweight concrete block	\geq V 2; $\rho \geq 1,2$ kg/dm ³	[kN]	0,26	0,21
	\geq V 6; $\rho \geq 1,6$ kg/dm ³	[kN]	0,26	0,71
Permissible load ³⁾⁵⁾ in vertically perforated brick (e.g. Poroton)	\geq HLz 10; $\rho \geq 1,0$ kg/dm ³	[kN]	0,17	0,26
Permissible load ³⁾ in perforated sand-lime brick	\geq KSL 6	[kN]	0,26	0,43
	\geq KSL 12	[kN]	0,57	0,57
Permissible load ³⁾⁵⁾ in hollow lightweight concrete blocks	\geq HBL 2	[kN]	-	0,43
	\geq HBL 6	[kN]	0,43	0,57
Minimum member thickness	h_{min}	[mm]	100	100
Minimum spacing (single anchor)	a_{min}	[mm]	250	250
Minimum spacing (anchor group)	s_{min}	[mm]	100	100
Minimum edge distance (anchor group)	c_{min}	[mm]	100	100
Anchorage in aerated concrete				
Permissible load ³⁾ in aerated concrete	2 N/mm ²	[kN]	-	0,14 ⁶⁾
	4 N/mm ²	[kN]	-	0,27
	6 N/mm ²	[kN]	-	0,27
Minimum member thickness	h_{min}	[mm]	-	100
Minimum spacing (single anchor)	a_{min}	[mm]	-	250
Minimum spacing (anchor group)	s_{min}	[mm]	-	400
Minimum edge distance (anchor group)	c_{min}	[mm]	-	100

¹⁾ The required partial safety factors for material resistance as well as a partial safety factor for load actions $\gamma_L = 1,4$ are considered.
As a single anchor counts e.g. an anchor with a minimum spacing a according to table B4.1 resp. table B4.2 of the assessment.

²⁾ Valid for temperatures in the substrate up to +50 °C (resp. short term up to +80 °C). For long term temperatures up to +30 °C higher permissible loads may be possible.

³⁾ Valid for tensile load, shear load and oblique load under any angle. For combinations of tensile loads, shear loads and bending moments see assessment.

⁴⁾ Valid for zinc coated screws and for screws made of stainless steel. For exterior use of the zinc coated screws measures against incoming humidity according to assessment have to be taken.

⁵⁾ Rotary drilling.

⁶⁾ Drill holes to be made with aerated concrete hole punch.

LOADS

Frame fixing SXR³⁾

Highest recommended loads¹⁾ for a single anchor as part of a multiple fixing of non-structural systems.
The given loads are valid for wood screws with the specified diameter.

Type		SXR 6	SXR 8
Anchorage depth	h_{nom} [mm]	30	50
Screw diameter	\emptyset [mm]	4,5	6,0
Min. edge distance concrete	a_r [mm]	50	60
Recommended loads in the respective base material F_{rec}²⁾			
Concrete	$\geq C20/25$ [kN]	0,25	0,40
Solid brick	$\geq Mz 12$ [kN]	0,20	0,30
Solid sand-lime brick	$\geq KS 12$ [kN]	0,20	0,30
Vertically perforated brick	$\geq Hlz 12$ ($\rho \geq 1,0 \text{ kg/dm}^3$) [kN]	0,10	0,10
Perforated sand-lime brick	$\geq KSL 12$ [kN]	0,20	0,30

¹⁾ Required safety factors are considered.

²⁾ Valid for tensile load, shear load and oblique load under any angle.

³⁾ Valid for zinc coated screws and for screws made of stainless steel. For exterior use of the zinc coated screws measures against incoming humidity have to be taken.

The lamella plug with gentle power transfer



5 Frame fixings / Stand-off installation

VERSIONS

- Zinc-plated steel
- Stainless steel

BUILDING MATERIALS

Approved for:

- Concrete \geq C12/15
- Vertically perforated brick
- Perforated sand-lime brick
- Solid sand-lime brick
- Solid brick made from lightweight concrete
- Solid brick

Also suitable for:

- Natural stone with dense structure
- Solid panel made from gypsum
- Hollow blocks made from lightweight concrete
- Three-layer composite exterior wall panels
- Lightweight aggregate concrete

CERTIFICATES



ADVANTAGES

- The operating principle with an anchorage depth of 70 mm and proven asymmetrical teeth, makes it an assembly-friendly anchor even in an unknown base material.
- The slim geometry guarantees a simple installation, even in cases involving thick wooden fixtures and narrow drill holes.
- Range available with diameters of 8 and 10 mm and usable lengths up to 160 mm.

APPLICATIONS

- Façade, ceiling and roof substructures made of wood and metal
- Windows
- Gates and doors
- Squared timbers
- Beams
- Wall covering

FUNCTIONING

- The FUR is suitable for push-through installation.
- Screwing in the screw causes the individual teeth to expand. In solid materials, the teeth create even expansion forces. In hollow materials, the teeth expand through the solid part of the block and form an undercut in the cavity.
- With vertically perforated bricks, only use rotary drilling (no impact drilling).
- FUR-T with countersunk head screw is recommended for the installation of timber constructions; in the case of metal constructions, use FUR-FUS with a wide sleeve rim and a moulded washer on the screw.

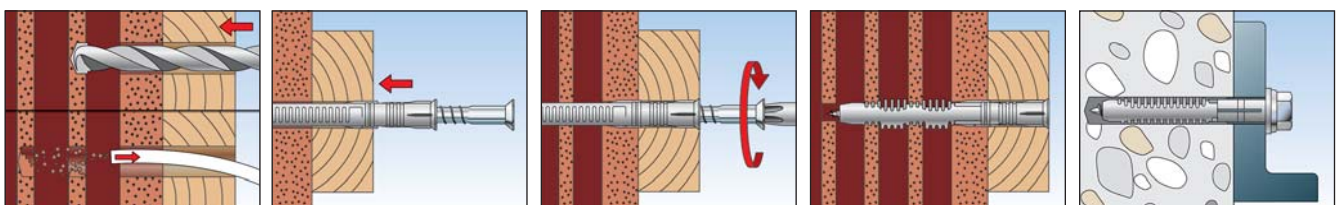

TECHNICAL DATA



FUR-T - with fischer countersunk head safety screw

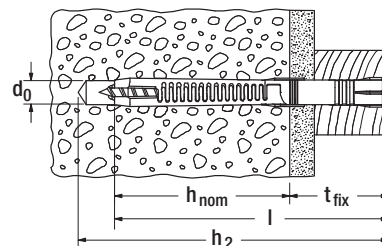

	Zinc-plated steel	Stainless steel	Approval	Drill hole diameter	Min. drill hole depth for through fixings	Min. anchorage depth	Anchor length	Max. fixture thickness	Drive	Sales unit
	Art.-No.	Art.-No.	ETA	d_0 [mm]	h_2 [mm]	h_{nom} [mm]	l [mm]	t_{fix} [mm]		[pcs]
Item	gvz	A4								
FUR 8 x 80 T	070110	070120	—	8	90	70	80	10	T30	50
FUR 8 x 100 T	070111	070121	—	8	110	70	100	30	T30	50
FUR 8 x 120 T	070112	070122	—	8	130	70	120	50	T30	50
FUR 10 x 80 T	088756	088784	■	10	90	70	80	10	T40	50
FUR 10 x 100 T	088757	088785	■	10	110	70	100	30	T40	50
FUR 10 x 115 T	088760	088791	■	10	125	70	115	45	T40	50
FUR 10 x 135 T	088758	088786	■	10	145	70	135	65	T40	50
FUR 10 x 160 T	088759	088787	■	10	170	70	160	90	T40	50
FUR 10 x 185 T	088761	088788	■	10	195	70	185	115	T40	50
FUR 10 x 200 T	088764	088789	■	10	210	70	200	130	T40	50
FUR 10 x 230 T	088762	088790	■	10	240	70	230	160	T40	50

TECHNICAL DATA



FUR-SS - with fischer hexagon head safety screw

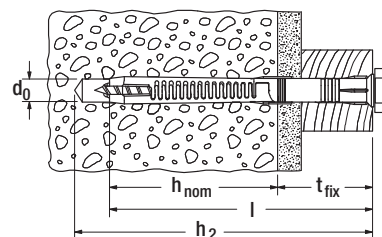

	Zinc-plated steel	Stainless steel	Approval	Drill hole diameter	Min. drill hole depth for through fixings	Min. anchorage depth	Anchor length	Max. fixture thickness	Drive	Sales unit
	Art.-No.	Art.-No.	ETA	d_0 [mm]	h_2 [mm]	h_{nom} [mm]	l [mm]	t_{fix} [mm]		[pcs]
Item	gvz	A4								
FUR 8 x 80 SS	070130	070140	—	8	90	70	80	10	SW 10	50
FUR 8 x 100 SS	070131	070141	—	8	110	70	100	30	SW 10	50
FUR 8 x 120 SS	070132	—	—	8	130	70	120	50	SW 10	50
FUR 10 x 80 SS	088776	088792	■	10	90	70	80	10	SW 13	50
FUR 10 x 100 SS	088777	088793	■	10	110	70	100	30	SW 13	50
FUR 10 x 115 SS	088783	088799	■	10	125	70	115	45	SW 13	50
FUR 10 x 135 SS	088778	088794	■	10	145	70	135	65	SW 13	50
FUR 10 x 160 SS	088779	088795	■	10	170	70	160	90	SW 13	50
FUR 10 x 185 SS	088780	088796	■	10	195	70	185	115	SW 13	50
FUR 10 x 200 SS	088781	088797	■	10	210	70	200	130	SW 13	50
FUR 10 x 230 SS	088782	088798	■	10	240	70	230	160	SW 13	50

TECHNICAL DATA



FUR-FUS - with fischer hexagon head safety screw, moulded washer and integrated bit recess

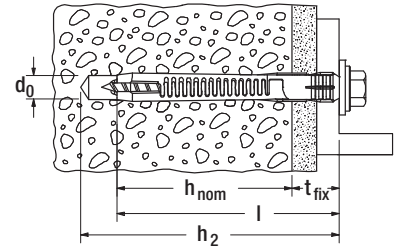

	Zinc-plated steel	Stainless steel	Approval	Drill hole diameter	Min. drill hole depth for through fixings	Min. anchorage depth	Anchor length	Max. fixture thickness	Drive	Sales unit
	Art.-No.	Art.-No.	ETA	d_0 [mm]	h_2 [mm]	h_{nom} [mm]	l [mm]	t_{fix} [mm]		[pcs]
Item	gvz	A4								
FUR 10 x 80 FUS	093527 ¹⁾	093528 ¹⁾	■	10	90	70	80	10	T40/SW13	50
FUR 10 x 100 FUS	097797 ¹⁾	—	■	10	110	70	100	30	T40/SW13	50

¹⁾ Collar: Ø 18 x 2 mm.

ACCESSORIES



Cover cap **ADT**

Item	Art.-No.	Colour	Cap [Ø mm]	Match	Sales unit [pcs]
ADT 15 W	060326	white	15	Safety screw with integrated bit recess T40	100
ADT 15 DB	060329	dark brown	15	Safety screw with integrated bit recess T40	100
ADT 18 W	060334	white	18	Safety screw with integrated bit recess T40	100
ADT 18 DB	060337	dark brown	18	Safety screw with integrated bit recess T40	100

ACCESSORIES



Washer **U**

Item	Art.-No.	External-Ø d [mm]	Hole-Ø D [mm]	Thickness S [mm]	Matching anchor type	Sales unit [pcs]
U 11,5 x 21 x 1,5 DIN 522 A2	010026	21	11.5	1.5	SXR 10, SXRL 10, FUR 10	500

LOADS

Frame fixing FUR 10⁴⁾

Highest permissible loads¹⁾²⁾ of a single anchor as part of a multiple fixing of non-structural systems. For the design the complete approval ETA-13/0235 has to be considered.

Product			FUR 10
Anchorage depth	h_{nom}	[mm]	70
Anchorage in concrete \geq C12/15			
Permissible tensile load		[kN]	1,79
Permissible shear load	Zinc-plated steel	[kN]	5,37
	Stainless steel A4	[kN]	4,98
Minimum member thickness	h_{min}	[mm]	110
Characteristic edge distance	$c_{cr,N}$	[mm]	140
Characteristic spacing	a resp. $s_{cr,N}$	[mm]	90
Minimum spacing	s_{min}	[mm]	70
with an edge distance	$c \geq$	[mm]	140
Minimum edge distance	c_{min}	[mm]	70
with a spacing	$s \geq$	[mm]	210
Anchorage in masonry			
Permissible load ³⁾ in solid brick	\geq Mz 12 a. \geq NF	[kN]	0,86
	\geq Mz 20 a. \geq NF	[kN]	0,86
Permissible load ³⁾ in solid sand-lime brick	\geq KS 10 a. \geq NF	[kN]	0,57
	\geq KS 20 a. \geq NF	[kN]	0,71
Permissible load ³⁾ in lightweight concrete block	\geq V 6; $\rho \geq 1,6$ kg/dm ³	[kN]	0,57
Permissible load ³⁾⁵⁾ in vertically perforated brick (e.g. Poroton)	\geq HLz 10; $\rho \geq 1,0$ kg/dm ³	[kN]	0,37
Permissible load ³⁾ in perforated sand-lime brick	\geq KSL 12	[kN]	0,57
Minimum member thickness	h_{min}	[mm]	110
Minimum spacing (single anchor)	a_{min}	[mm]	250
Minimum spacing (anchor group)	s_{min}	[mm]	100
Minimum edge distance (anchor group)	c_{min}	[mm]	100

¹⁾ The required partial safety factors for material resistance as well as a partial safety factor for load actions $\gamma_F = 1,4$ are considered. As a single anchor counts e.g. an anchor with a minimum spacing a according to table 8 resp. table 10 of the approval.

²⁾ Valid for temperatures in the substrate up to +50 °C (resp. short term up to +80 °C).

³⁾ Valid for tensile load, shear load and oblique load under any angle. For combinations of tensile loads, shear loads and bending moments see approval.

⁴⁾ Valid for zinc coated screws and for screws made of stainless steel. For exterior use of the zinc coated screws measures against incoming humidity according to approval have to be taken.

⁵⁾ Rotary drilling.

LOADS

Frame fixing FUR 8³⁾

Highest recommended loads¹⁾ for a single anchor for multiple fixings of non-structural systems. The given loads are valid for fischer safety screws included in delivery.

Type			FUR 8
Anchorage depth	h_{nom}	[mm]	70
Diameter of the safety screw	\emptyset	[mm]	6,0
Min. edge distance concrete	a_f	[mm]	50
Recommended loads in the respective base material F_{rec}²⁾			
Concrete	\geq C12/15	[kN]	1,0
Solid brick	\geq Mz 12	[kN]	0,60
Solid sand-lime brick	\geq KS 12	[kN]	0,60

¹⁾ Required safety factors are considered.

²⁾ Valid for tensile load, shear load and oblique load under any angle.

³⁾ Valid for zinc coated screws and for screws made of stainless steel. For exterior use of the zinc coated screws measures against incoming humidity have to be taken.

The elastic protective coating for use with frame fixings



Sealing of the screw heads

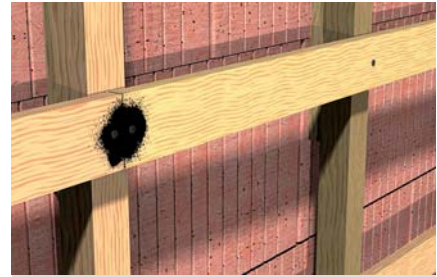

Sealing of the screw heads

BUILDING MATERIALS

- Zinc-plated frame fixings
- Corrosive metals

ADVANTAGES

- FTC-CP professionally prevents the penetration of moisture into the anchor shaft and securely protects the connection from corrosion - as required in the ETA assessments.
- Once dry, the optimised formulation provides a long-lasting, elastic protective coating with a secure hold and a high abrasion resistance.
- The thixotropic anti-corrosion agent is also ideally suited to other corrosion protection applications and thus offers a wide range of uses.

APPLICATIONS

- Façade anchorings in line with the assessments for frame fixings, e.g. SXR, SXRL and FUR
- For all substructures, e.g. made from wood, aluminium, metal.

FUNCTIONING

- Thixotropic, bitumen-based anti-corrosion agent.
- Good stability under load; non-drip, no spray mist.
- Shake canister for at least 2 minutes from the time the mixing balls can be heard.
- Spray as evenly as possible from a distance of 15 to 20 cm.
- Ideal processing temperature +16 °C to +25 °C.
- Quick-drying (dried through after 3-4 hours at 600 mµ and 20 °C).
- Temperature-resistant from -25 °C to 80 °C.
- Salt and water-resistant, and resistant to abrasion.
- With one can about 300 screw heads can be coated.

TECHNICAL DATA



Anti-corrosion spray **FTC-CP**

Item	Art.-No.	Colour	Content per can [ml]	Sales unit [pcs]
FTC-CP	511440	black	500	12

The hammer-in plug for a simple, fast and economical installation



Timber substructures



Cable ducts

VERSIONS

- Zinc-plated steel
- Stainless steel

BUILDING MATERIALS

- Concrete
- Solid sand-lime brick
- Building brick
- Natural stone
- Solid brick made from lightweight concrete
- Aerated concrete
- Solid panel made from gypsum
- Vertically perforated brick
- Perforated sand-lime brick
- Hollow blocks made from lightweight concrete

CHARACTERISTICS



ADVANTAGES

- The rapid hammerset installation reduces the amount of time required and allows for an economic series installation.
- The integrated hammer-in stop prevents the plug from expanding prematurely (jamming), thus enabling a problem-free installation.
- Together with the cross-slot recess, the thread of the nail screw allows the screw to be removed, thus allowing for subsequent dismantling.
- The wide range of diameters, usage lengths and head shapes provides the correct plug for every fixing.

APPLICATIONS

- Substructures made of wood and metal
- Wall connection or plaster profiles
- Slides
- Sheets
- Cable and pipe clips
- Perforated tapes

FUNCTIONING

- The Hammerfix N is suitable for push-through installation.
- When hammered in, the nail screw causes the plug to expand in two directions, thus providing a secure anchoring in the building material.
- Countersunk head plugs are recommended for the installation of timber constructions; in the case of metal constructions, use flat-head plugs, and use pan-head plugs for long holes.

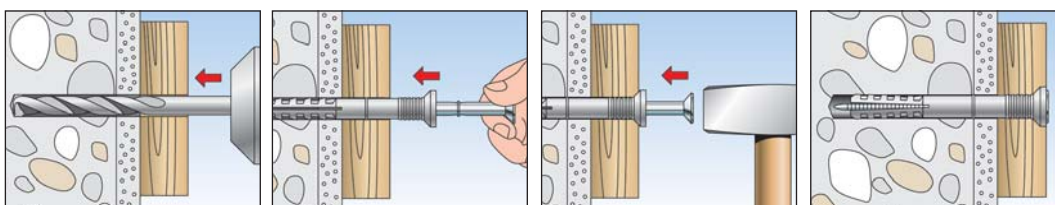

TECHNICAL DATA



Hammerfix **N-S** with nail



Hammerfix **N-S A2** with stainless steel A2 nail

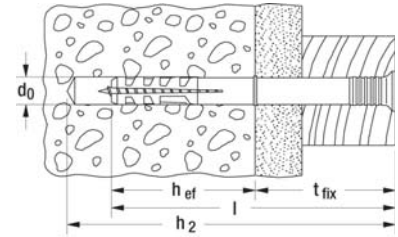

5 Frame fixings / Stand-off installation

Item	Zinc-plated steel	Stainless steel A2	Drill hole diameter	Effect. anchorage depth	Anchor length	Min. drill hole depth for through fixings	Max. fixture thickness	Drive	Sales unit
	Art.-No.	Art.-No.	d_0 [mm]	h_{ef} [mm]	l [mm]	h_2 [mm]	t_{fix} [mm]		[pcs]
	gvz	A2							
N 5 x 30/5 S (100)	050395 ²⁾	050370	5	25	30	45	5	PZ2	100
N 5 x 40/15 S (100)	050351	—	5	25	40	55	15	PZ2	100
N 5 x 50/25 S (100)	050352	—	5	25	50	65	25	PZ2	100
N 6 x 40/10 S (50)	050354	050372	6	30	40	55	10	PZ2	50
N 6 x 40/10 S (100)	048788	—	6	30	40	55	10	PZ2	100
N 6 x 40/10 S (200)	513834 ²⁾	—	6	30	40	55	10	PZ2	200
N 6 x 60/30 S (50)	050355	050373	6	30	60	75	30	PZ2	50
N 6 x 60/30 S (100)	048789	—	6	30	60	75	30	PZ2	100
N 6 x 60/30 S (200)	513835 ²⁾	—	6	30	60	75	30	PZ2	200
N 6 x 80/50 S (50)	050353	—	6	30	80	95	50	PZ2	50
N 6 x 80/50 S (100)	048790	—	6	30	80	95	50	PZ2	100
N 6 x 80/50 S (200)	513836 ²⁾	—	6	30	80	95	50	PZ2	200
N 8 x 60/20 S (50)	050356	050374	8	40	60	75	20	PZ3	50
N 8 x 60/20 S (100)	048791	—	8	40	60	75	20	PZ3	100
N 8 x 80/40 S (50)	050358	050375	8	40	80	95	40	PZ3	50
N 8 x 80/40 S (100)	048792	—	8	40	80	95	40	PZ3	100
N 8 x 100/60 S (50)	050357	050376	8	40	100	115	60	PZ3	50
N 8 x 100/60 S (100)	048793	—	8	40	100	115	60	PZ3	100
N 8 x 120/80 S (50)	050359	—	8	40	120	135	80	PZ3	50
N 8 x 120/80 S (100)	048794	—	8	40	120	135	80	PZ3	100
N 10 x 100/50 S (50)	050346 ¹⁾	—	10	50	100	115	50	PZ3	50
N 10 x 135/85 S (50)	050347 ¹⁾	—	10	50	135	150	85	PZ3	50
N 10 x 160/110 S (50)	050348 ¹⁾	—	10	50	160	175	110	PZ3	50
N 10 x 230/180 S (50)	050335 ¹⁾	—	10	50	230	245	180	PZ3	50

1) not pre-assembled

2) also specially suitable for fischer pipe clips FC, see chapter electrical fixings.

TECHNICAL DATA



Hammerfix **N-F** with cylindrical head and nail

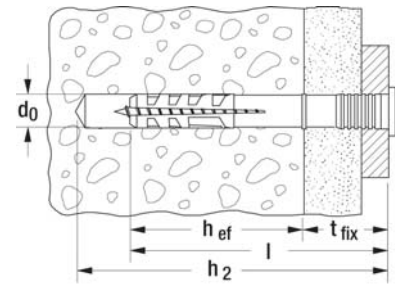

Item	Art.-No.	Drill hole diameter	Effect. anchorage depth	Anchor length	Min. drill hole depth for through fixings	Max. fixture thickness	Drive	Sales unit
		d_0 [mm]	h_{ef} [mm]	l [mm]	h_2 [mm]	t_{fix} [mm]		[pcs]
N 5 x 25/1 F (100)	514872	5	25	25	40	1	PZ2	100
N 5 x 25/1 F (200)	514873	5	25	25	40	1	PZ2	200
N 5 x 30/5 F (100)	513736	5	25	30	45	5	PZ2	100
N 5 x 30/5 F (200)	513739	5	25	30	45	5	PZ2	200
N 5 x 40/15 F (100)	513737	5	25	40	55	15	PZ2	100
N 5 x 40/15 F (200)	513740	5	25	40	55	15	PZ2	200
N 5 x 50/25 F (100)	513738	5	25	50	65	25	PZ2	100
N 5 x 50/25 F (200)	513741	5	25	50	65	25	PZ2	200
N 6 x 35/5 F (100)	522948	6	30	35	40	5	PZ2	100
N 6 x 40/10 F (50)	513837	6	30	40	55	10	PZ2	50
N 6 x 40/10 F (100)	513840	6	30	40	55	10	PZ2	100
N 6 x 40/10 F (200)	513843	6	30	40	55	10	PZ2	200
N 6 x 60/30 F (50)	513838	6	30	60	75	30	PZ3	50
N 6 x 60/30 F (100)	513841	6	30	60	75	30	PZ2	100
N 6 x 60/30 F (200)	513844	6	30	60	75	30	PZ2	200
N 6 x 80/50 F (50)	513839	6	30	80	95	50	PZ3	50
N 6 x 80/50 F (100)	513842	6	30	80	95	50	PZ2	100
N 6 x 80/50 F (200)	513845	6	30	80	95	50	PZ2	200
N 8 x 60/20 F (50)	513697	8	40	60	75	20	PZ3	50
N 8 x 60/20 F (100)	513701	8	40	60	75	20	PZ3	100
N 8 x 80/40 F (50)	513698	8	40	80	95	40	PZ3	50
N 8 x 80/40 F (100)	513702	8	40	80	95	40	PZ3	100
N 8 x 100/60 F (50)	513699	8	40	100	115	60	PZ3	50
N 8 x 100/60 F (100)	513703	8	40	100	115	60	PZ3	100
N 8 x 120/80 F (50)	513700	8	40	120	135	80	PZ3	50
N 8 x 120/80 F (100)	513704	8	40	120	135	80	PZ3	100

TECHNICAL DATA



Hammerfix **N-P** with flat edge and nail



Hammerfix **N-P A2** with flat edge and stainless steel A2 nail

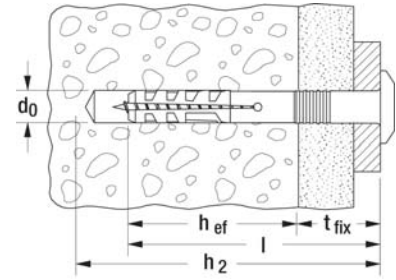

	Zinc-plated steel	Stainless steel A2	Drill hole diameter	Effect. anchorage depth	Anchor length	Min. drill hole depth for through fixings	Max. fixture thickness	Drive	Sales unit
	Art.-No.	Art.-No.	d_0 [mm]	h_{ef} [mm]	l [mm]	h_2 [mm]	t_{fix} [mm]		[pcs]
Item	gvz	A2							
N 5 x 30/5 P (100)	050338	—	5	25	30	45	5	PZ2	100
N 6 x 30/1 P (100)	514869	—	6	30	30	45	1	PZ2	100
N 6 x 40/7 P (50)	050339	050369	6	30	40	55	7	PZ2	50
N 6 x 40/7 P (100)	048795	092520	6	30	40	55	7	PZ2	100
N 6 x 40/7 P (200)	514871	—	6	30	40	55	7	PZ2	200
N 8 x 40/1 P (50)	015903	—	8	40	40	55	1	PZ3	50
N 8 x 40/1 P (100)	514870	—	8	40	40	55	1	PZ3	100

TECHNICAL DATA



Hammerfix **N-P K** with flat edge and plastic nail



N-S M with nail and connection thread M 6



Hammerfix **N-S D A2** with isolating washer and nail

		Drill hole diameter	Effect. anchorage depth	Anchor length	Max. fixture thickness	Min. drill hole depth for through fixings	Washer	Drive	Sales unit
	Art.-No.	d_0 [mm]	h_{ef} [mm]	l [mm]	t_{fix} [mm]	h_2 [mm]	[Ø mm]		[pcs]
Item									
N 6 x 40/7 P K (50)	050342	6	30	40	7	55	—	—	50
N 6 x 40/10 S M6 (50)	050398	6	30	40	10	55	—	—	50
N 6 x 40/10 S D A2 (50)	050367	6	30	40	10	55	19	PZ2	50
N 6 x 60/30 S D A2 (50)	050368	6	30	60	30	75	19	PZ2	50

LOADS

Hammerfix N

Highest recommended loads¹⁾ for a single anchor

The given loads are valid for screw nails with the specified diameter.

Type		N5	N6 ³⁾	N8	N10
Screw nail diameter	Ø [mm]	3,5	4	5	7
Recommended loads in the respective base material F_{rec}²⁾					
Concrete	≥ C20/25 [kN]	0,20	0,25	0,27	0,33
Solid brick	≥ Mz 12 [kN]	0,14	0,18	0,24	0,30
Solid sand-lime brick	≥ KS 12 [kN]	0,18	0,22	0,24	0,33
Solid brick of lightweight aggregate concrete	≥ V 4 [kN]	0,05	0,12	0,15	0,16
Aerated concrete	≥ PB 2 [kN]	0,03	0,04	0,05	0,10
Aerated concrete	≥ PB 4 [kN]	0,07	0,10	0,13	0,16

¹⁾ Required safety factors are considered.

³⁾ The values have to be reduced by 50% for N 6 x 40/7 P K.

²⁾ Valid for tensile load, shear load and oblique load under any angle.

The hammer-in plug for simple, fast and economic installation



Timber substructures

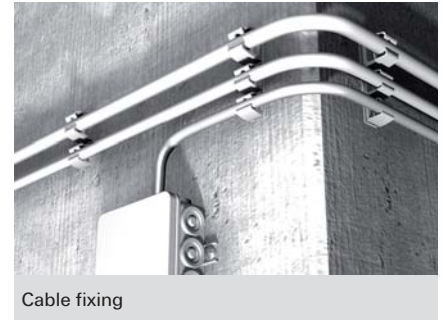

Cable fixing

BUILDING MATERIALS

- Concrete
- Solid sand-lime brick
- Building brick
- Natural stone
- Solid brick made from lightweight concrete
- Aerated concrete
- Solid panel made from gypsum
- Vertically perforated brick
- Perforated sand-lime brick
- Hollow blocks made from lightweight concrete

CHARACTERISTICS



ADVANTAGES

- Produced with at least 50% renewable raw materials and therefore particularly environmentally friendly.
- Just as effective, secure and durable as regular hammerfix N plugs.
- The rapid push-through and hammer-set installation reduces the amount of work required and allows for economic series installation.
- The integrated hammer-in stop prevents the plug from expanding prematurely, thus enabling problem-free installation.
- Together with the cross-slot recess, the thread of the nail screw allows the screw to be removed, thus allowing for subsequent dismantling.

APPLICATIONS

- Substructures made of wood and metal
- Wall connection or plaster profiles
- Slides
- Sheets
- Cable and pipe clips
- Perforated tapes

FUNCTIONING

- The hammerfix N GREEN is suitable for push-through installation.
- The easiest installation: drill, knock in and you're done.
- When being hammered in, the nail screw causes the plug to expand in two directions, thus providing a secure anchoring in the building material.

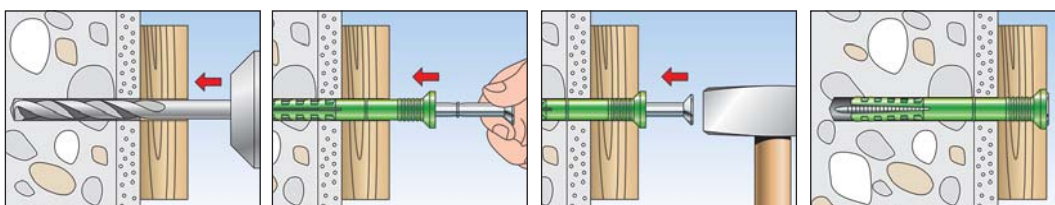

TECHNICAL DATA



Hammerfix **N GREEN S** with countersunk head and zinc-plated nail

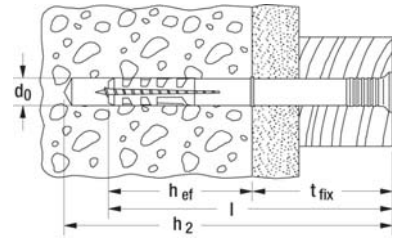

Item	Art.-No.	Drill hole diameter d_0 [mm]	Effect. anchorage depth h_{ef} [mm]	Anchor length l [mm]	Min. drill hole depth for through fixings h_2 [mm]	Max. fixture thickness t_{fix} [mm]	Drive	Sales unit [pcs]
N GREEN 6 x 40/10 S	524845	6	30	40	55	10	PZ2	45
N GREEN 6 x 60/30 S	524847	6	30	60	75	30	PZ2	45
N GREEN 6 x 80/50 S	524848	6	30	80	95	50	PZ2	45
N GREEN 8 x 80/40 S	524849	8	40	80	95	40	PZ3	45
N GREEN 8 x 100/60 S	524850	8	40	100	115	60	PZ3	45

LOADS

Hammerfix N GREEN S

Highest recommended loads¹⁾ for a single anchor.

The given loads are valid for screw nails with the specified diameter.

Type		N GREEN 6	N GREEN 8
Screw nail diameter	\emptyset [mm]	4	5
Recommended loads in the respective base material F_{rec}²⁾			
Concrete	\geq C20/25 [kN]	0,25	0,27
Solid brick	\geq Mz 12 [kN]	0,18	0,24
Solid sand-lime brick	\geq KS 12 [kN]	0,22	0,24
Solid brick of lightweight aggregate concrete	\geq V 4 [kN]	0,12	0,15
Aerated concrete	\geq AAC 2 [kN]	0,04	0,05
Aerated concrete	\geq AAC 4 [kN]	0,10	0,13

¹⁾ Required safety factors are considered.

²⁾ Valid for tensile load, shear load and oblique load under any angle.

The user-friendly spring sleeve for light fixings in solid building materials



BUILDING MATERIALS

- Concrete
- Solid sand-lime brick
- Natural stone with dense structure
- Solid brick

ADVANTAGES

- No plugs or screws are required for the one-piece nail sleeve. This guarantees a simple and easy installation.
- The geometry of the nail sleeve makes it easy to push it into the drill hole. This saves time and money.

APPLICATIONS

- Squared timbers
- Substructures made of wood and metal
- Metal profiles

FUNCTIONING

- The FNH nail sleeve is suitable for push-through installation.
- The nail sleeve is hammered in and expands its entire length in the hole.
- FNH is suitable for interior applications and for temporary external fixings.

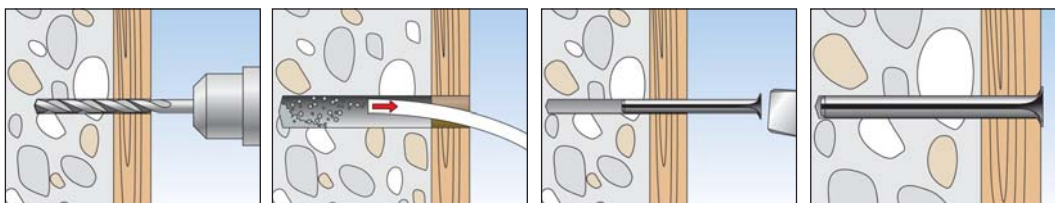

TECHNICAL DATA



Nail sleeve FNH

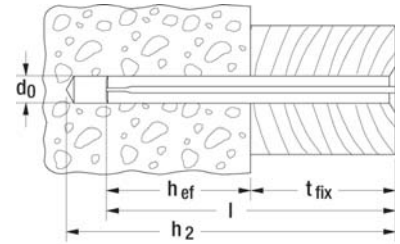

5 Frame fixings / Stand-off installation

Item	Art.-No.	Drill hole diameter d_0 [mm]	Effect. anchorage depth h_{ef} [mm]	Anchor length l [mm]	Max. fixture thickness t_{fix} [mm]	Min. drill hole depth for through fixings h_2 [mm]	Sales unit [pcs]
FNH 5/50	541893	5	20	50	30	60	100
FNH 6/30	541894	6	30	30	—	40	100
FNH 6/40	541895	6	30	40	10	50	100
FNH 6/50	541896	6	30	50	20	60	100
FNH 6/60	541897	6	30	60	30	70	100
FNH 6/80	541898	6	30	80	50	90	100
FNH 8/70	541899	8	40	70	30	80	100
FNH 8/90	541905	8	40	90	50	100	50
FNH 8/110	541906	8	40	110	70	120	50
FNH 8/130	541907	8	40	130	90	140	50
FNH 8/150	541908	8	40	150	110	160	50
FNH 8/180	541909	8	40	180	140	190	50

LOADS

Nail sleeve FNH

Highest recommended loads¹⁾ of a single anchor as part of a multiple fixing of non-structural systems.

Type		FNH 5	FNH 6	FNH 8
Minimum member thickness	[mm]	50	60	70
Anchorage in concrete ≥ C20/25				
Recommended tensile load	[kN]	0,10	0,50	0,70
Recommended shear load	[kN]	0,40	1,40	2,00

¹⁾ Required safety factors are considered.

The nylon fixing for stress-free stand-off installation of window and door frames



Window frames

BUILDING MATERIALS

- Concrete
- Vertically perforated brick
- Hollow blocks made from lightweight concrete
- Perforated sand-lime brick
- Solid sand-lime brick
- Aerated concrete
- Solid brick made from lightweight concrete
- Solid brick

CERTIFICATES



ADVANTAGES

- The operating principle of the plug prevents the frame from being pulled against the substrate, and ensures a stress-free and long-lasting fixing of the frame.
- The special plug geometry anchors the metal and plastic profiles against compressive and tensile loads, and allows for a secure hold of the window frame.
- The cover cap (available separately) can be used to discreetly cover the screw head.

APPLICATIONS

- Window frames
- Door frames

FUNCTIONING

- The F-S is suitable for push-through installation.
- By tightening the screw, the glass-fibre-reinforced plastic cone is drawn into the sleeve, whereby it is expanded and wedged inside the drill hole. The window frames are thus fixed in a stress-free manner.
- The maximum installation torque is 3 Nm for F8S and 6 Nm for F10S.

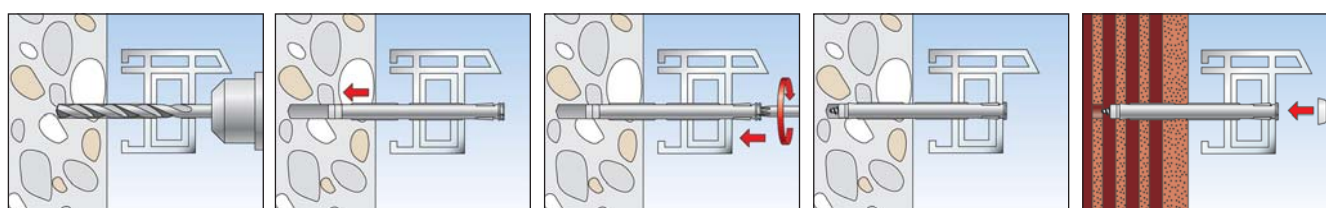

TECHNICAL DATA



F-S - with zinc-plated countersunk screw and cross drive Z3

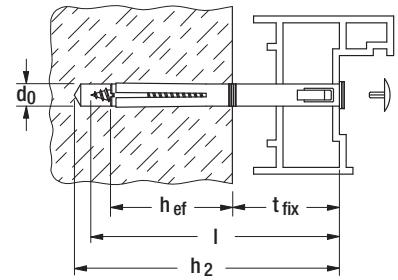

Item	Art.-No.	Drill hole diameter d_0 [mm]	Effect. anchorage depth h_{ef} [mm]	Anchor length l [mm]	Max. fixture thickness t_{fix} [mm]	Min. drill hole depth for through fixings h_2 [mm]	Max. installation torque T_{inst} [Nm]	Sales unit [pcs]
F 8 S 100	088635	8	40	100	50	115	3	50
F 8 S 120	088636	8	40	120	70	135	3	50
F 8 S 140	088637	8	40	140	90	155	3	50
F 10 S 75	088625	10	50	75	15	90	6	50
F 10 S 100	088626	10	50	100	40	115	6	50
F 10 S 120	088627	10	50	120	60	135	6	50
F 10 S 140	088628	10	50	140	80	155	6	50
F 10 S 165	088629	10	50	165	105	180	6	50

ACCESSORIES



Cover cap for **F-S** - with countersunk screw and cross drive Z3

Item	Art.-No.	Diameter [mm]	Colour	Sales unit [pcs]
ADF 12W	060275	12	white	100

LOADS

Window frame fixing F-S

Highest recommended loads¹⁾ for a single anchor as part of a multiple fixing of non-structural systems.

Type		F 8 S	F 10 S
Recommended loads in the respective base material F_{rec}²⁾			
Concrete	$\geq C20/25$ [kN]	0,78	1,48
Solid brick	$\geq Mz 12$ [kN]	0,90	1,25
Solid sand-lime brick	$\geq KS 12$ [kN]	0,90	1,25
Solid brick of lightweight aggregate concrete	$\geq V 2$ [kN]	0,25	-
Perforated sand-lime brick	$\geq KSL 6$ [kN]	0,25	-

¹⁾ Required safety factors are considered.

²⁾ Valid for tensile load, shear load and oblique load under any angle.

The fixing for stress-free installation of window and door frames with fire classification



Fire protection doors

BUILDING MATERIALS

- Concrete
- Vertically perforated brick
- Hollow blocks made from lightweight concrete
- Perforated sand-lime brick
- Solid sand-lime brick
- Aerated concrete
- Solid brick made from lightweight concrete
- Solid brick

CERTIFICATES



ADVANTAGES

- The F-M metal frame plug achieves fire resistance F 120. This allows for use in areas where fire resistance is relevant.
- The operating principle prevents the window frame from being pulled against the substrate, and ensures a stress-free and long-lasting fixing of the frame.
- The special plug geometry anchors the metal and plastic profiles against compressive and tensile loads, and allows for a secure hold of the window frame.
- The cover caps (available separately) can be used to discreetly cover the screw heads.

APPLICATIONS

- Window frames
- Door frames
- Squared timbers

FUNCTIONING

- The F-M is suitable for push-through installation.
- By tightening the screw, the cone is drawn into the sleeve and the fixing is expanded which wedges it inside the drill hole. The window frames are thus fixed in a stress-free manner.
- The maximum installation torque is 5 Nm.

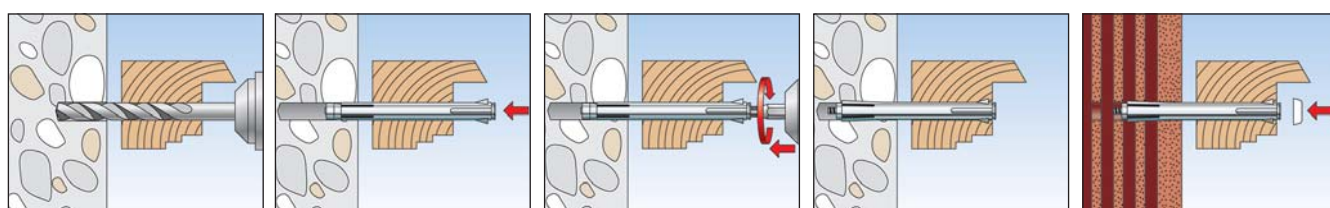

TECHNICAL DATA



F 8 M - with zinc-plated raised countersunk screw and cross drive PZ2

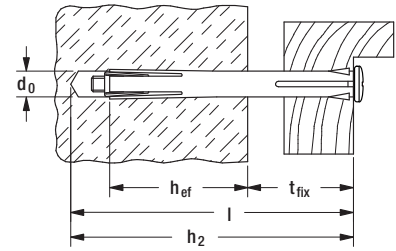

Item	Art.-No.	Drill hole diameter d_0 [mm]	Min. drill hole depth for through fixings h_2 [mm]	Effect. anchorage depth h_{ef} [mm]	Anchor length l [mm]	Max. fixture thickness t_{fix} [mm]	Drive	Sales unit [pcs]
F 8 M 72	088660	8	90	30	72	42	PZ2	100
F 8 M 92	088662	8	110	30	92	62	PZ2	100
F 8 M 112	088664	8	130	30	112	82	PZ2	100
F 8 M 132	088666	8	150	30	132	102	PZ2	100

TECHNICAL DATA



F 10 M - with zinc-plated countersunk head screw and cross drive PZ3

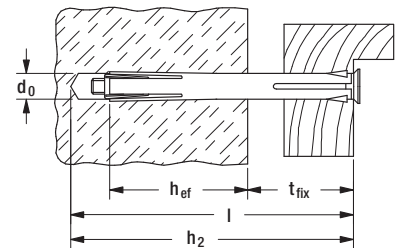

Item	Art.-No.	Drill hole diameter d_0 [mm]	Min. drill hole depth for through fixings h_2 [mm]	Effect. anchorage depth h_{ef} [mm]	Anchor length l [mm]	Max. fixture thickness t_{fix} [mm]	Drive	Sales unit [pcs]
F 10 M 72	088670	10	90	30	72	42	PZ3	100
F 10 M 92	088672	10	110	30	92	62	PZ3	100
F 10 M 112	088674	10	130	30	112	82	PZ3	100
F 10 M 132	088676	10	150	30	132	102	PZ3	100
F 10 M 152	088678	10	170	30	152	122	PZ3	100
F 10 M 182	088680	10	200	30	182	152	PZ3	50
F 10 M 202	061064	10	220	30	202	172	PZ3	50

ACCESSORIES



Cover cap **ADM 10 W**

Item	Art.-No.	Colour	Cap height [mm]	Cap [Ø mm]	Match	Sales unit [pcs]
ADM 10 W	088688	white	4	16,5	F 10 M	100
ASM 10 W	060320	white	3	15	F 10 M	100

LOADS

Metal frame fixing F-M

Highest recommended loads¹⁾ for a single anchor as part of a multiple fixing of non-structural systems.

Type			F 8 M	F 10 M
Recommended loads in the respective base material F_{rec}²⁾				
Concrete	≥ C20/25	[kN]	1,00	1,40
Solid brick	≥ Mz 12	[kN]	0,30	1,30
Solid sand-lime brick	≥ KS 12	[kN]	0,70	1,30
Solid brick of lightweight aggregate concrete	≥ V 2	[kN]	-	0,50
Perforated sand-lime brick	≥ KSL 12	[kN]	0,25	0,60

¹⁾ Required safety factors are considered.

²⁾ Valid for tensile load, shear load and oblique load under any angle.

The economical special screw for window installation

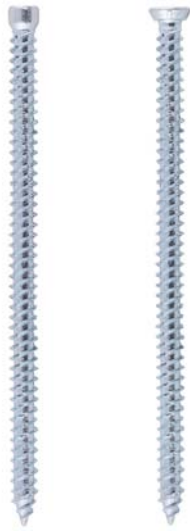

BUILDING MATERIALS

- Concrete
- Vertically perforated brick
- Hollow blocks made from lightweight concrete
- Perforated sand-lime brick
- Solid sand-lime brick
- Solid brick made from lightweight concrete
- Solid brick
- Aerated concrete

CERTIFICATES



Test Report No.:
14-000559-PR02

ADVANTAGES

- Screw installation without plug for economical processing.
- The small drill bit diameter of 6 mm allows for efficient series installation.
- The continuous thread ensures a stress-free fixing of the frame in the substrate.
- The high-low-thread at the screw tip as well as several cutting notches reduce the amount of force required for screwing in the screws. The installation process can be completed without excessive effort.
- With two head types applicable for all common frame materials.
- According to the ift Rosenheim suitable for the fixation of a plastic window in brick masonry.

APPLICATIONS

- Window frames made of wood, plastic and aluminium
- Door frames
- Squared timbers

FUNCTIONING

- Note the drill hole and screw-in depths for the different building materials listed in the table.
- Cylinder head screws are recommended for recessed installation in wooden profiles.
- Flat head screws are recommended for installation in plastic and aluminium profiles.

INSTALLATION

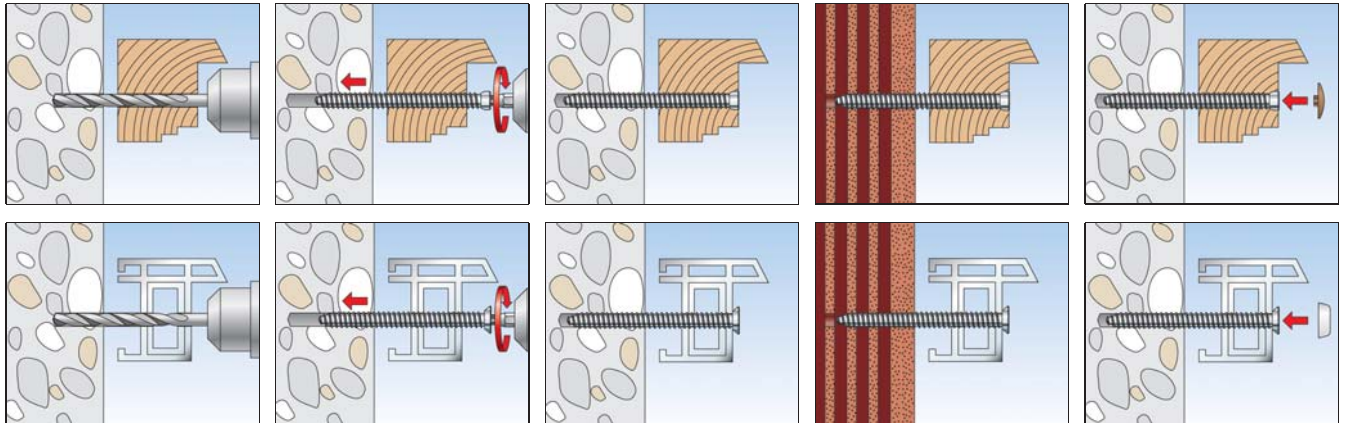

TECHNICAL DATA



Window frame screw with cylinder head
FFSZ

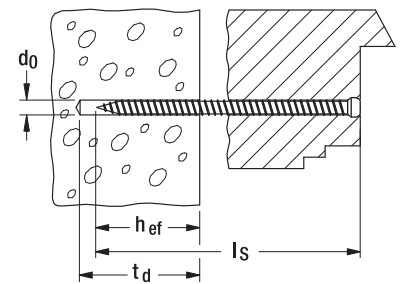

Anchorage depth h_{ef}
 $h_{ef} \geq 30$ mm in concrete
 $h_{ef} \geq 40$ mm in solid brick
 $h_{ef} \geq 60$ mm in perforated brick /
 aerated concrete

t_d : drill hole depth $\geq h_{ef} + 10$ mm

Item	Art.-No.	Drill hole diameter	Screw length	Drive	Head	Sales unit
		d_0 [mm]	l_s [mm]		[Ø mm]	
FFSZ 7,5 x 52 T30	532906	6	52	T30	8	100
FFSZ 7,5 x 62 T30	532907	6	62	T30	8	100
FFSZ 7,5 x 72 T30	532908	6	72	T30	8	100
FFSZ 7,5 x 82 T30	532909	6	82	T30	8	100
FFSZ 7,5 x 92 T30	532910	6	92	T30	8	100
FFSZ 7,5 x 102 T30	532911	6	102	T30	8	100
FFSZ 7,5 x 112 T30	532912	6	112	T30	8	100
FFSZ 7,5 x 122 T30	532913	6	122	T30	8	100
FFSZ 7,5 x 132 T30	532914	6	132	T30	8	100
FFSZ 7,5 x 152 T30	532915	6	152	T30	8	100
FFSZ 7,5 x 182 T30	532916	6	182	T30	8	100
FFSZ 7,5 x 202 T30	532917	6	202	T30	8	100
FFSZ 7,5 x 212 T30	532919	6	212	T30	8	100
FFSZ 7,5 x 252 T30	532920	6	252	T30	8	100
FFSZ 7,5 x 302 T30	532921	6	302	T30	8	100

No pre-drilling in aerated concrete.

TECHNICAL DATA



Window frame screw with flat head **FFS**

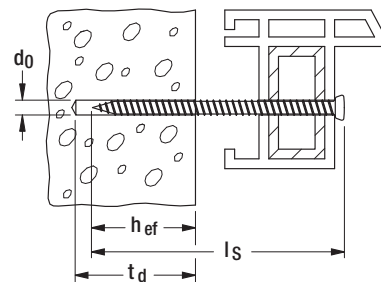

Anchorage depth h_{ef}
 $h_{ef} \geq 30$ mm in concrete
 $h_{ef} \geq 40$ mm in solid brick
 $h_{ef} \geq 60$ mm in perforated brick / aerated concrete

t_d : drill hole depth $\geq h_{ef} + 10$ mm

Item	Art.-No.	Drill hole diameter	Screw length	Drive	Head	Sales unit
		d_0 [mm]	l_s [mm]		[Ø mm]	
FFS 7,5 x 42 T30	532922	6	42	T30	11,5	100
FFS 7,5 x 52 T30	532923	6	52	T30	11,5	100
FFS 7,5 x 62 T30	532925	6	62	T30	11,5	100
FFS 7,5 x 72 T30	532927	6	72	T30	11,5	100
FFS 7,5 x 82 T30	532928	6	82	T30	11,5	100
FFS 7,5 x 92 T30	532930	6	92	T30	11,5	100
FFS 7,5 x 102 T30	532931	6	102	T30	11,5	100
FFS 7,5 x 112 T30	532932	6	112	T30	11,5	100
FFS 7,5 x 122 T30	532934	6	122	T30	11,5	100
FFS 7,5 x 132 T30	532935	6	132	T30	11,5	100
FFS 7,5 x 152 T30	532941	6	152	T30	11,5	100
FFS 7,5 x 182 T30	532942	6	182	T30	11,5	100
FFS 7,5 x 202 T30	532943	6	202	T30	11,5	100
FFS 7,5 x 212 T30	532944	6	212	T30	11,5	100
FFS 7,5 x 252 T30	532945	6	252	T30	11,5	100
FFS 7,5 x 302 T30	532946	6	302	T30	11,5	100

No pre-drilling in aerated concrete.

ACCESSORIES



Cover cap **FFSZ-A**

Item	Art.-No.	Colour	Cap	Cap height	Match	Sales unit
			[Ø mm]	[mm]		
FFSZ-A W	538708	white	14	2,2	FFSZ - cylinder head	100
FFSZ-A BR	538709	brown	14	2,2	FFSZ - cylinder head	100

ACCESSORIES



Cover cap **FFS-A**

Item	Art.-No.	Colour	Cap	Cap height	Match	Sales unit
			[Ø mm]	[mm]		
FFS-A W	061560	white	15	4,8	FFS - flat head	100
FFS-A BR	061561	brown	15	4,8	FFS - flat head	100

LOADS

Window frame screws FFSZ and FFS

Highest recommended loads¹⁾ of a single screw.

Type		FFSZ			FFS			
Screw diameter	∅	[mm]	7,5			7,5		
Anchorage depth	$h_{ef} \geq$	[mm]	30	40	60	30	40	60
Anchorage in concrete \geq C20/25								
Recommended tensile load		[kN]	1,00	-		1,00	-	
Recommended shear load		[kN]	0,70	-		0,70	-	
Min. edge distance ⁵⁾	c_{min}	[mm]	30	-		30	-	
Anchorage in masonry								
Recommended tensile load in solid brick	\geq Mz 12	[kN]	-	0,40 ³⁾	0,80	-	0,40 ³⁾	0,80
Recommended shear load in solid brick	\geq Mz 12	[kN]	-	0,30 ³⁾	0,70	-	0,30 ³⁾	0,70
Recommended tensile load in solid sand-lime brick	\geq KS 12	[kN]	-	1,00	-	-	1,00	-
Recommended shear load in solid sand-lime brick	\geq KS 12	[kN]	-	0,60	-	-	0,60	-
Recommended tensile load in vertically perforated brick	\geq HLz 12	[kN]	-	-	0,25 ³⁾	-	-	0,25 ³⁾
Recommended shear load in vertically perforated brick	\geq HLz 12	[kN]	-	-	0,40 ³⁾	-	-	0,40 ³⁾
Min. edge distance ⁵⁾	c_{min}	[mm]	-	40		-	40	
Anchorage in aerated concrete								
Recommended load ²⁾ in aerated concrete	\geq AAC 2	[kN]	-	0,10 ⁴⁾		-	0,10 ⁴⁾	
	\geq AAC 4	[kN]	-	0,25 ⁴⁾		-	0,25 ⁴⁾	
Min. edge distance ⁵⁾	c_{min}	[mm]	-	40		-	40	

¹⁾ Required safety factors are considered. As a single screw counts e.g. a screw with a spacing $s \geq 3 \times h_{ef}$ and an edge distance $c \geq 1,5 \times h_{ef}$.

²⁾ Valid for tensile load, shear load and oblique load under any angle.

³⁾ Rotary drilling.

⁴⁾ Without pre-drilling.

⁵⁾ Minimal possible edge distance while reducing the recommended loads.

The stainless steel A4 joint for two-shell masonry



BUILDING MATERIALS

- All concrete and masonry materials in conjunction with the appropriate frame fixing

ADVANTAGES

- The VB securely connects the facing masonry with the load-bearing layer.
- The high quality A4 stainless steel connecting wire guarantees a long-lasting fixing.
- The VB is flexible and can be mounted on any point of the external wall.

APPLICATIONS

- Two-shell external walls (facings)
- Closers and economy facings

FUNCTIONING

- The frame fixings SXR 10, SXRL 10 and FUR 10 are suitable for the anchoring of wall ties in concrete and masonry.

TECHNICAL DATA



Item	Art.-No.	Contents	Sales unit [pcs]
VB	050495 ¹⁾	1 wire anchor stainless steel A4, 1 washer stainless steel A4, 1 drip ring	50

¹⁾ Wire: angled 265 mm.

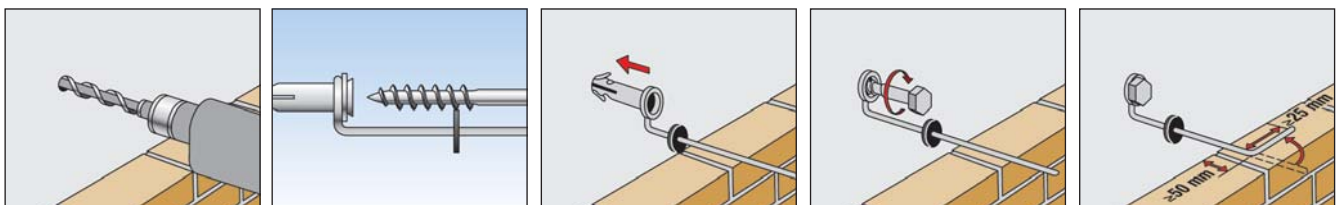

5 Frame fixings / Stand-off installation

The fixing for infinite adjustment of timber constructions in all standard solid building materials



BUILDING MATERIALS

- Concrete
- Wood
- Solid sand-lime brick
- Natural stone with dense structure
- Aerated concrete
- Solid panel made from gypsum
- Solid brick made from lightweight concrete
- Solid brick

CERTIFICATES



ADVANTAGES

- The combination of adjustment plug and spacing screw allows for universal usage in wooden and solid building materials.
- The special operating principle of the adjustable fixing S10J and the spacing screw allows for infinite adjustment. This saves on the use of wedges and blocks when fixing the fixture.

APPLICATIONS

- Substructures made of wooden battens of 20-25 mm thickness.

FUNCTIONING

- The S10J is suitable for push-through installation.
- Once the screw has been screwed in, the fixture distance can be infinitely adjusted by modifying the rotation direction.
- For the fixing of wood on wood, e.g. in the roof truss, only use adjustment screw JS.

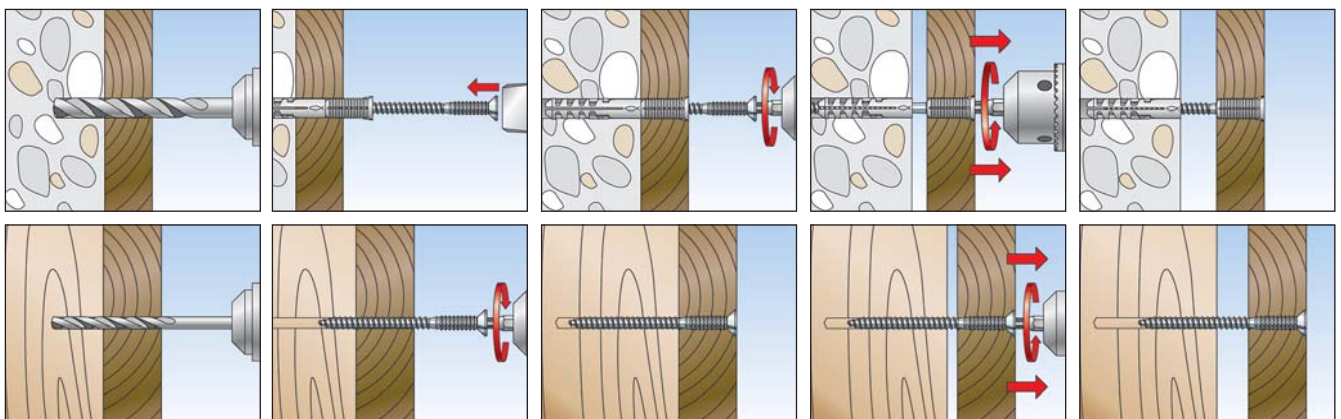

TECHNICAL DATA



Adjustable fixing **S 10 J 75 S**

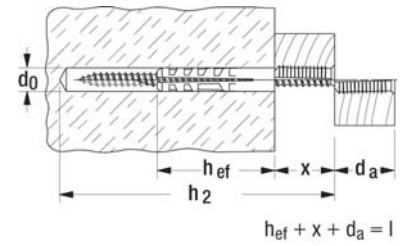

Item	Art.-No.	Drill hole diameter d_0 [mm]	Min. drill hole depth for through fixings h_2 [mm]	Effect. anchorage depth h_{ef} [mm]	Anchor length l [mm]	Max. timber thickness d_a [mm]	Max. adjustment travel x [mm]	Sales unit [pcs]
S 10 J 75 S	080710	10	115	50	75	25	30	50

TECHNICAL DATA



Adjustable screw **JS**

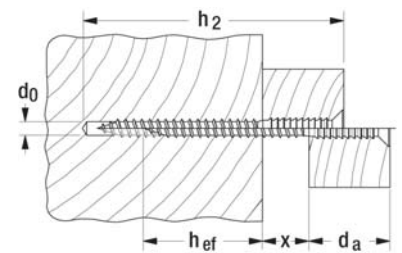

Item	Art.-No.	Drill hole diameter d_0 [mm]	Min. drill hole depth for through fixings h_2 [mm]	Effect. anchorage depth h_{ef} [mm]	Max. timber thickness d_a [mm]	Max. adjustment travel x [mm]	Sales unit [pcs]
JS 6 x 110	080700	5	50 - 110	30	25	55	50

5
Frame fixings / Stand-off installation

The adjustable screw for fast and infinitely adjustable installation of timber constructions

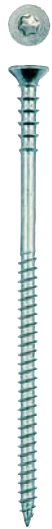

Stand-off installations



Stand-off installations

BUILDING MATERIALS

- Wood and wooden materials or wooden panels

ADVANTAGES

- The special operating principle of the adjustable screw JUSS allows for infinite adjustment. This saves on the use of wedges and blocks when fixing the fixture.
- The self-drilling thread cuts directly into the wood. Therefore pre-drilling is not required. For the installation in hardwood pre-drilling is recommended.

APPLICATIONS

- Substructures made of wooden battens of 20-25 mm thickness.

FUNCTIONING

- The JUSS is suitable for push-through installation.
- Once the screw has been screwed in, the parallel thread below the screw head causes the fixture to initially pull against the substrate. The fixture distance can then be infinitely adjusted by modifying the rotation direction.

TECHNICAL DATA



Adjustable screw **JUSS**

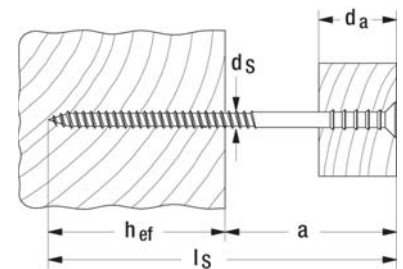

Item	Art.-No.	Effect anchorage depth h_{ef} [mm]	Max. distance a [mm]	Screw $d_s \times l_s$ [mm]	Max. timber thickness d_a [mm]	Drive	Sales unit [pcs]
JUSS 6 x 60	059040	30	30	6 x 60	20	T25	100
JUSS 6 x 70	059041	30	40	6 x 70	25	T25	100
JUSS 6 x 80	059042	30	50	6 x 80	25	T25	100
JUSS 6 x 90	059043	30	60	6 x 90	25	T25	100
JUSS 6 x 100	059044	30	70	6 x 100	25	T25	100
JUSS 6 x 110	059045	30	80	6 x 110	25	T25	100
JUSS 6 x 120	059046	30	90	6 x 120	25	T25	100
JUSS 6 x 145	059047	30	115	6 x 145	25	T25	100

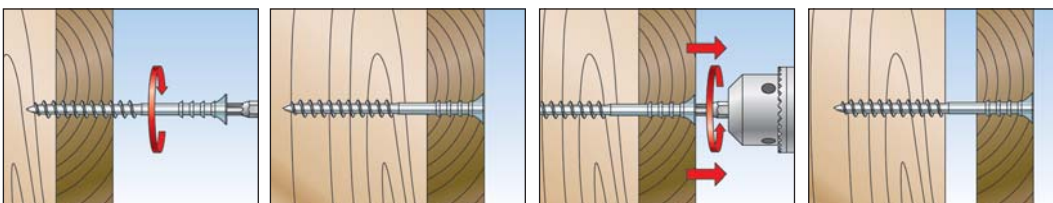

The spacing screw for flexible positioning and alignment of wooden fixtures

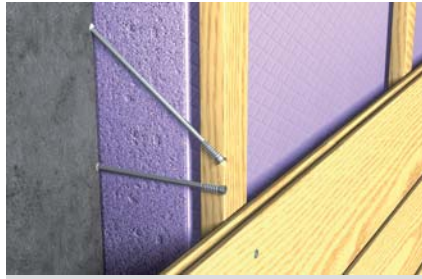

Stand-off installations



Stand-off installations

BUILDING MATERIALS

- Without plug: suitable for wooden materials and wooden panels
- With SX or UX plugs: all concrete and masonry materials

ADVANTAGES

- The coordinated threads with the same pitch allow for the pin-point positioning and alignment of the fixture, which can even be mounted at an angle to the screw. This allows for an exact and flexible fixing.
- During the installation, the fixture is not pulled onto the substrate, instead it is brought directly to the desired distance and position. This allows for a simple and exact installation.
- When combined with SX 8 and UX 8 plugs, it can be used in almost all wall materials, guaranteeing a secure fixing.

APPLICATIONS

- Window frames
- Door frames
- Squared timbers
- Claddings
- Substructures made of wood

FUNCTIONING

- The ASL is suitable for push-through installation.
- Pre-drill the fixture at the desired angle in order to achieve the correct positioning and alignment.
- When screwing in the screw, the external thread cuts into the pre-drilled fixture, and fixes it into the stipulated position.
- The angled position of the screws (15° - 30°) allows high shear loads to be supported.

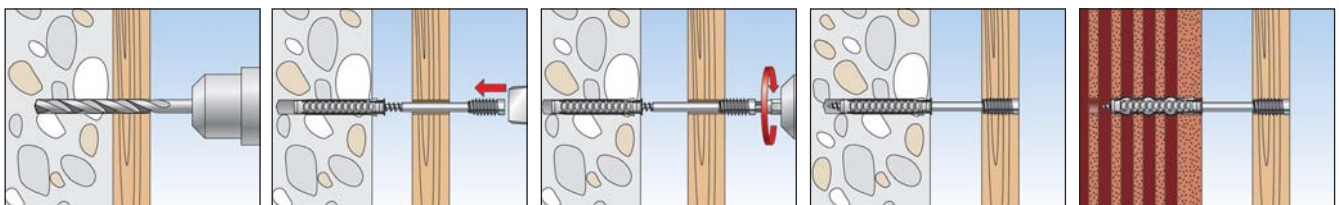

5 Frame fixings / Stand-off installation

TECHNICAL DATA

 Spacing screw **ASL**

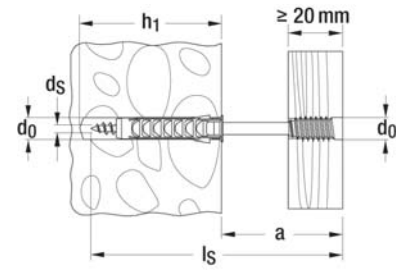

Item	Art.-No.	Drill hole diameter	Min. drill hole depth	Max. distance	Screw	Drive	Sales unit
		d_0 [mm]	h_1 [mm]	a [mm]	$d_s \times l_s$ [mm]		[pcs]
ASL 4,5 x 60	059050	6	40	25	4,5 x 60	T25	100
ASL 4,5 x 70	059051	6	40	35	4,5 x 70	T25	100
ASL 4,5 x 80	059052	6	40	45	4,5 x 80	T25	100
ASL 4,5 x 100	059054	6	40	65	4,5 x 100	T25	100
ASL 6 x 80	059061	8	55	35	6 x 80	T25	100
ASL 6 x 100	059062	8	55	55	6 x 100	T25	100
ASL 6 x 120	059063	8	55	75	6 x 120	T25	100
ASL 6 x 150	059064	8	55	105	6 x 150	T25	50

The thermally separated stand-off installation in external thermal insulation composite systems (ETICS)

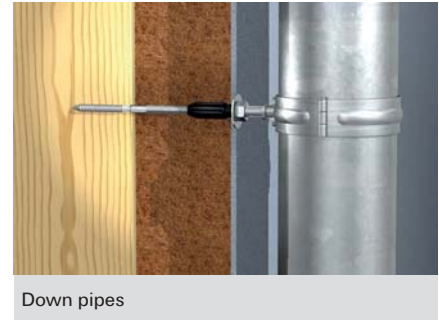

BUILDING MATERIALS

- Concrete
- Vertically perforated brick
- Hollow blocks made from lightweight concrete
- Perforated sand-lime brick
- Solid sand-lime brick
- Building brick
- Aerated concrete
- Wood

ADVANTAGES

- The stand-off installation allows for the fixture to be adjusted to the exact position required, whereby pressure marks and damage to the ETICS are avoided.
- The plastic cone creates a thermal barrier between the fixture and the inner fixture, and offers an energy-optimised fixing.
- The glass-fibre-reinforced plastic cone cuts its own way through the ETICS with a positive fit, and allows for a simple and fast installation without the need for any special tools.
- Combining Thermax 8 and 10 with the universal plug UX provides a secure anchoring in the substrate.
- Without UX plug direct mounting in wood substrate is possible after pre-drilling.

APPLICATIONS

For the thermally separated fixing of:

- Signs
- Lighting
- Letter boxes
- Motion detectors
- Downpipes
- Lightning rods
- Blind guide rails

FUNCTIONING

- The Thermax 8 and 10 systems are suitable for pre-positioned installation.
- The self-tapping, glass-fibre-reinforced cone cuts its own way through the plaster into the insulation during installation.
- The anti-cold cone uses a thermal barrier to minimise heat losses.
- Installation without any special tools.
- For use in wood without plug, the wood (footnote below load table) as well as the plaster has to be pre-drilled:
Thermax 8:
 $d_{02} = 14 \text{ mm}$, $h_{02} = 50 \text{ mm}$;
Thermax 10:
 $d_{02} = 18 \text{ mm}$, $h_{02} = 50 \text{ mm}$
- The extensive range features fitting options with metric screws (M6/8/10), sheet screws (6.3 mm), chipboard screws (6.0 mm) or chipboard screws (4.5 - 5.5 mm) when using an SX 5 expansion plug.

INSTALLATION - MASONRY

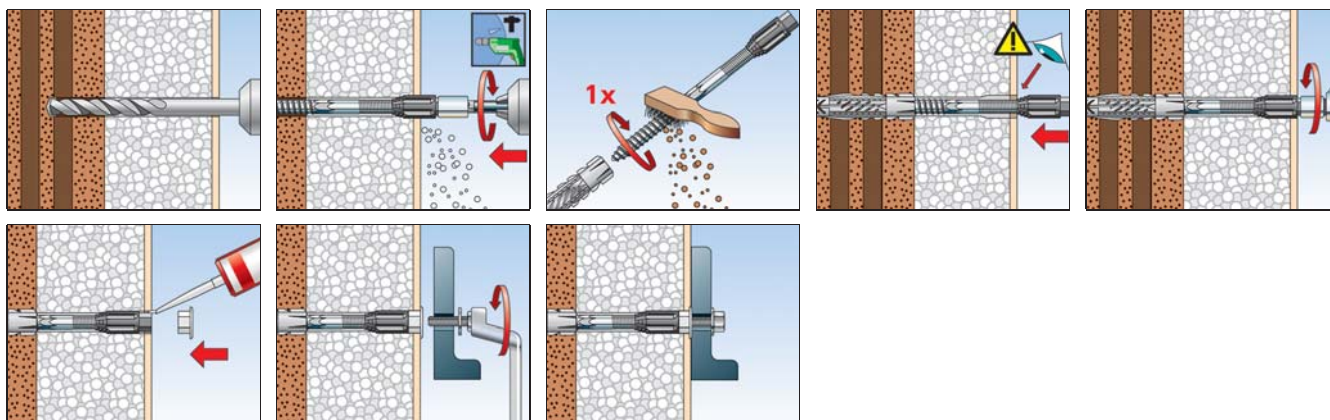

INSTALLATION - WOOD SUBSTRATE

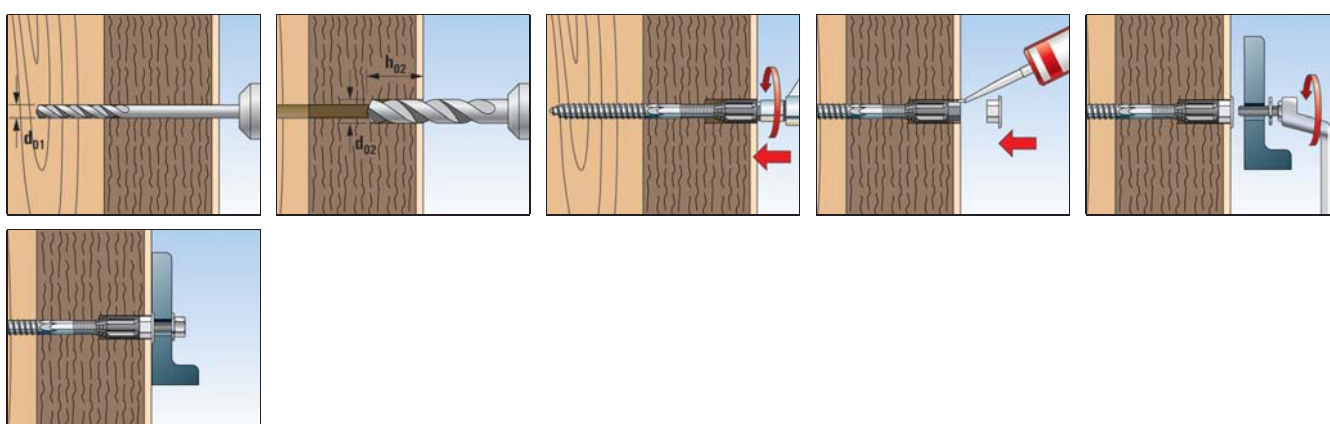

TECHNICAL DATA



Thermax 8 and 10

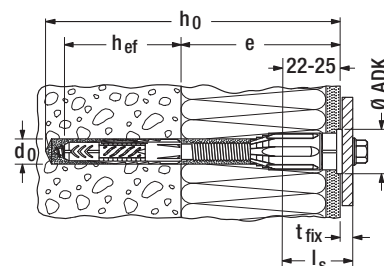

Item	Art.-No.	Drill hole diameter d_0 [mm]	Drill hole depth h_0 [mm]	Usable length e [mm]	Anchorage depth h_{ef} [mm]	Cover cap-Ø ADK [mm]	Width across nut Ø SW [mm]	Chipboard / metric / sheet metal screw	Sales unit [pcs]
Thermax 8/60 M6	045685 1) 2)	10	120	45 - 60	60	18	10	4,5 - 6,0 / M6 / 6,3	20
Thermax 8/80 M6	045686 1) 2)	10	140	60 - 80	60	18	10	4,5 - 6,0 / M6 / 6,3	20
Thermax 8/100 M6	045687 1) 2)	10	160	80 - 100	60	18	10	4,5 - 6,0 / M6 / 6,3	20
Thermax 8/120 M6	045688 1) 2)	10	180	100 - 120	60	18	10	4,5 - 6,0 / M6 / 6,3	20
Thermax 8/140 M6	045689 1) 2)	10	200	120 - 140	60	18	10	4,5 - 6,0 / M6 / 6,3	20
Thermax 8/160 M6	045690 1) 2)	10	220	140 - 160	60	18	10	4,5 - 6,0 / M6 / 6,3	20
Thermax 8/180 M6	045691 1) 2)	10	240	160 - 180	60	18	10	4,5 - 6,0 / M6 / 6,3	20
Thermax 10/100 M6	045692 1) 2)	12	160	80 - 100	70	22	13	4,5 - 6,0 / M6 / 6,3	20
Thermax 10/120 M6	045693 1) 2)	12	180	100 - 120	70	22	13	4,5 - 6,0 / M6 / 6,3	20
Thermax 10/140 M6	045694 1) 2)	12	200	120 - 140	70	22	13	4,5 - 6,0 / M6 / 6,3	20
Thermax 10/160 M6	045695 1) 2)	12	220	140 - 160	70	22	13	4,5 - 6,0 / M6 / 6,3	20
Thermax 10/180 M6	045696 1) 2)	12	240	160 - 180	70	22	13	4,5 - 6,0 / M6 / 6,3	20
Thermax 10/200 M6	512605 1) 2)	12	260	180 - 200	70	22	13	4,5 - 6,0 / M6 / 6,3	20

1) including SX 5

2) Min. screw length $l_s = 22\text{mm} + \text{thickness of mounting member } e$; for use in wood without universal plug UX, consider drill hole diameter in footnote under load table.

TECHNICAL DATA



Thermax 8 and 10

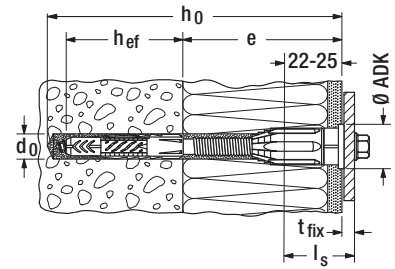

5 Frame fixings / Stand-off installation

Item	Art.-No.	Drill hole diameter d_0 [mm]	Drill hole depth h_0 [mm]	Usable length e [mm]	Anchorage depth h_{ef} [mm]	Cover cap-Ø ADK [mm]	Width across nut \varnothing_{SW} [mm]	Chipboard / metric / sheet metal screw	Sales unit [pcs]
Thermax 10/220 M6	514250 1) 2)	12	280	200 - 220	70	22	13	4,5 - 6,0 / M6 / 6,3	20
Thermax 10/240 M6	514251 1) 2)	12	300	220 - 240	70	22	13	4,5 - 6,0 / M6 / 6,3	20
Thermax 10/100 M8	045697 2)	12	160	80 - 100	70	22	13	M8	20
Thermax 10/120 M8	045698 2)	12	180	100 - 120	70	22	13	M8	20
Thermax 10/140 M8	045699 2)	12	200	120 - 140	70	22	13	M8	20
Thermax 10/160 M8	045700 2)	12	220	140 - 160	70	22	13	M8	20
Thermax 10/180 M8	514252 2)	12	240	160 - 180	70	22	13	M8	20
Thermax 10/200 M8	514253 2)	12	260	180 - 200	70	22	13	M8	20
Thermax 10/220 M8	514254 2)	12	280	200 - 220	70	22	13	M8	20
Thermax 10/240 M8	514255 2)	12	300	220 - 240	70	22	13	M8	20
Thermax 10/100 M10	045702 2)	12	160	80 - 100	70	22	13	M10	20
Thermax 10/120 M10	045703 2)	12	180	100 - 120	70	22	13	M10	20
Thermax 10/140 M10	045704 2)	12	200	120 - 140	70	22	13	M10	20
Thermax 10/160 M10	045705 2)	12	220	140 - 160	70	22	13	M10	20
Thermax 10/180 M10	514256 2)	12	240	160 - 180	70	22	13	M10	20
Thermax 10/200 M10	514257 2)	12	260	180 - 200	70	22	13	M10	20
Thermax 10/220 M10	514258 2)	12	280	200 - 220	70	22	13	M10	20
Thermax 10/240 M10	514259 2)	12	300	220 - 240	70	22	13	M10	20

1) including SX 5

2) Min. screw length $l_s = 22\text{mm} + \text{thickness of mounting member } e$; for use in wood without universal plug UX, consider drill hole diameter in footnote under load table.

LOADS

Stand-off installation Thermax 8 and 10

Highest recommended loads¹⁾ of a single anchor in concrete and masonry.

Type		Thermax 8	Thermax 10
Supplied type of plug for the anchorage in the base material		UX 10 x 60	UX 12 x 70
Recommended tensile loads in the respective base material N_{rec}²⁾			
Concrete ³⁾⁴⁾	$\geq \text{C20/25}$ [kN]	1,00	1,00
Solid brick ³⁾⁴⁾	$\geq \text{Mz 12}$ [kN]	0,50	0,70
Perforated sand-lime brick ³⁾⁴⁾	$\geq \text{KSL 12}$ [kN]	0,60	0,80
Vertically perforated brick ⁴⁾	$\geq \text{Hz 12}$ [kN]	0,20	0,30
Aerated concrete ³⁾⁴⁾	$\geq \text{PB 4}$ [kN]	0,40	0,60
Recommended shear load V_{rec}, valid für all above mentioned base materials for the stated insulation thickness			
External Thermal Insulation Composite System ⁵⁾	$\leq 240\text{ mm}$ [kN]	0,15	0,20

¹⁾ Required safety factors are considered.

²⁾ The drilling method is to be adapted to the building material used. As different joint qualities are possible, the given values only apply for installation in the brick.

³⁾ The given recommended tensile loads apply for fastenings with metric screws. When using chipboard screws with diameter 6,0 mm they have to be reduced to 0,35 kN.

⁴⁾ The given recommended tensile loads apply for fastenings with metric screws. When using a SX 5-plug chipboard screws with diameter 4,5 - 5,5 mm they have to be reduced to 0,1 kN.

⁵⁾ Values are valid for an ETICS made from PS- respectively PU-rigid foam panels. Thickness of rendering minimum 6 mm.

The approved stand-off installation with thermal barrier in external thermal insulation composite systems (ETICS)

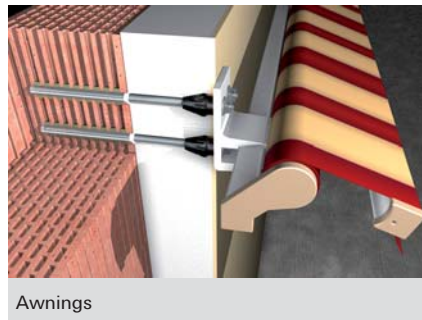

VERSIONS

- Zinc-plated steel
- Stainless steel

BUILDING MATERIALS

Approved for:

- Concrete, cracked and non-cracked
- Vertically perforated brick
- Hollow blocks made from lightweight concrete
- Perforated sand-lime brick
- Solid sand-lime brick
- Solid brick
- Aerated concrete

CERTIFICATES



ADVANTAGES

- When combined with the injection mortars FIS EM Plus, FIS V, FIS SB and FIS GREEN, the stand-off installation is approved for high loads in a range of materials. This allows for a secure fixing.
- Usable lengths of 62 to 290 mm can be covered with just one Thermax.
- The plastic cone creates a thermal barrier between the fixture and the inner fixture, and offers an energy-optimised fixing.
- The glass-fibre-reinforced plastic cone cuts its own way through the ETICS with a positive fit, and allows for a simple, fast and adjustable installation without the need for any special tools.

APPLICATIONS

For the thermally separated fixing of:

- Awnings
- Canopies
- French balcony railings
- Air conditioning units
- Satellite dishes

FUNCTIONING

- The Thermax 12 and 16 systems are suitable for pre-positioned installation.
- The self-tapping, glass-fibre-reinforced cone cuts its own way through the plaster into the insulation during installation.
- The anti-cold cone uses a thermal barrier to minimise heat losses.
- In the case of resistant plaster (e.g. thick cement plaster), it is recommended that the Thermax cutting blade included is used for grinding out the plaster.
- The sealing of the annular gap with sealing adhesive KD or construction sealant Premium DKM seals the facade at plaster level.

SEE ALSO



FIS EM PLUS
mortar
Page 86



FIS V
mortar
Page 101



FIS SB
mortar
Page 64



FIS GREEN
mortar
Page 126

INSTALLATION

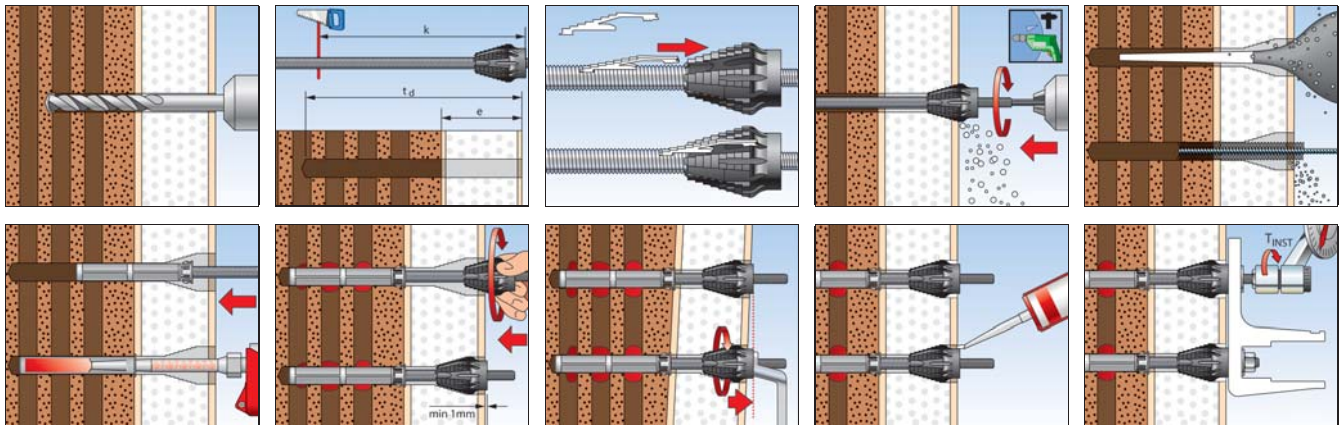

TECHNICAL DATA



Thermax 12/110 M12



Thermax 16/170 M12



Item	Zinc-plated steel	Stainless steel	Approval DIBt	Contents	Sales unit
	Art.-No.	Art.-No.			[pcs]
Thermax 12/110 M12	051291	—	●	20 Thermax M12, 20 perforated sleeves 20 x 130, 5 bits, 5 cutting blades, 5 user manuals	20
Thermax 12/110 M12	—	051537	●	10 Thermax M12 A4, 10 perforated sleeves 20 x 130, 3 bits, 3 cutting blades, 3 user manuals	10
Thermax 12/110 M12 B	051290	—	●	2 Thermax M12, 2 perforated sleeves 20 x 130, 1 bit, 1 cutting blade, 1 user manual	1
Thermax 16/170 M12	051293	—	●	20 Thermax M16, 20 perforated sleeves 20 x 200, 5 bits, 5 cutting blades, 5 applicator tip extension hoses, 5 user manuals	20
Thermax 16/170 M12	—	051543	●	10 Thermax M16 A4, 10 perforated sleeves 20 x 200, 3 bits, 3 cutting blades, 3 applicator tip extension hoses, 3 user manuals	10
Thermax 16/170 M12 B	051292	—	●	2 Thermax M16, 2 perforated sleeves 20 x 200, 1 bit, 1 cutting blade, 1 applicator tip extension hose, 1 user manual	1

INSTALLATION DATA

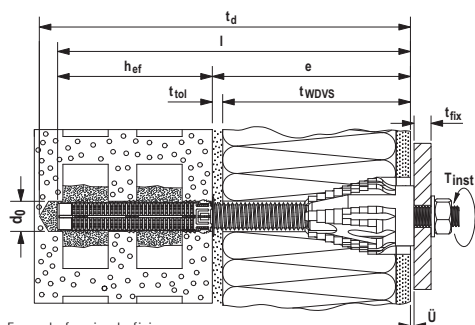

Example for simple fixing

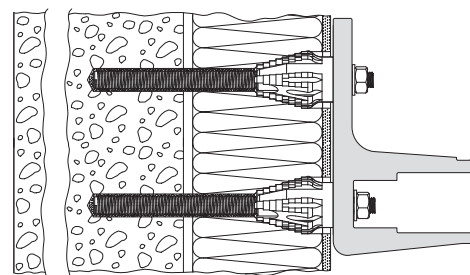

Example for multiple fixing

Type	Length of Thermax incl. anti-cold cone l [mm]	Threaded rod in building material	Building material + insulation						Fixture			Required resin quantity [Scale unit]
			Building material	Suitable injection anchor sleeve	Drill hole diameter d ₀ [mm]	Min. anchorage depth h _{ef} [mm]	Drill hole depth t _d [mm]	Thickness of non-bearing layer e [mm]	Max. fixture thickness t _{fix} [mm]	Con-nection thread	Max. instal-lation torque T _{inst} [Nm]	
Thermax M12	240	M12	Concrete		14	70	$h_{ef} + e$	62 - 170	16 ¹⁾	M12	20	5
			Solid brick		14	80	$h_{ef} + e$	62 - 160				6
			Perforated brick	FIS H 20x130 K	20	130	$h_{ef} + e + 10 \text{ mm}$	62 - 110				26
			Aerated concrete		14	100	$h_{ef} + e$	62 - 140				8
Thermax M16	370	M16	Concrete		18	80	$h_{ef} + e$	62 - 290	16 ¹⁾	M12	20	7
			Solid brick		18	80	$h_{ef} + e$	62 - 290				7
			Perforated brick	FIS H 20x200 K	20	200	$h_{ef} + e + 10 \text{ mm}$	62 - 170				40
			Aerated concrete		18	100	$h_{ef} + e$	62 - 270				9

1) The setscrews may be replaced by a setscrew / fixing screw up to a length 200 mm.

TECHNICAL DATA



Epoxy mortar
FIS EM Plus 390 S



Superbond mortar
FIS SB 390 S



Injection mortar
FIS V 360 S



All-round adhesive gluing and sealing
KD-290



Injection mortar
FIS GREEN 300 T



Construction sealant Premium
DKM WHITE 290ML

Item	Art.-No.	Approval		Languages on the cartridge	Contents	Sales unit
		DIBt	ETA			
FIS EM Plus 390 S	544154	●	■	DE, EN, FR, NL, ES, PT	1 cartridge 390 ml, 2 x FIS MR Plus	6
FIS EM Plus 390 S	544155	●	■	EN, ZH, EL, KO, HU, PL	1 cartridge 390 ml, 2 x FIS MR Plus	6
FIS V 360 S	094404	●	■	DE, FR, NL, TR, HU, AR	1 cartridge 360 ml, 2 x FIS MR Plus	6
FIS V 360 S	094405	●	■	EN, IT, PT, ES, ZH, JA	1 cartridge 360 ml, 2 x FIS MR Plus	6
FIS SB 390 S	519451	●	■	DE, FR, NL	1 cartridge 390 ml, 2 x FIS MR Plus	6
FIS SB 390 S	518831	●	■	EN, ES, PT	1 cartridge 390 ml, 2 x FIS MR Plus	6
FIS GREEN 300 T	522989	—	■	FR	1 cartridge 300 ml, 2 x FIS MR Plus with transparent Clip	4
FIS GREEN 300 T	523245	—	■	IT	1 cartridge 300 ml, 2 x FIS MR Plus with transparent Clip	12
FIS GREEN 300 T	538219	—	■	CS, SK	1 cartridge 300 ml, 2 x FIS MR Plus	12
FIS GREEN 300 T	532972	—	■	DA, SV, NO, FI	1 cartridge 300 ml, 2 x FIS MR Plus with transparent Clip	12
KD WHITE 290ML	059389	—	—	DE, EN	1 cartridge 290 ml	12
DKM-290ML	517598	—	—	DE, EN	1 cartridge 290 ml	12

ACCESSORIES DRILL HOLE CLEANING

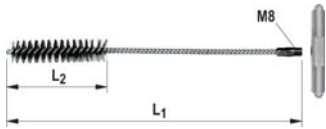

Cleaning brush **BS**

Item	Art.-No.	Length L ₁ [mm]	Length L ₂ [mm]	Brush diameter [mm]	For drill diameter [mm]	Sales unit [pcs]
BS ø 14	078180	250	80	16	14	1
BS ø 16/18	078181	250	80	20	16/18	1
BS ø 20/22	052277	180	80	25	20/22	1

ACCESSORIES DRILL HOLE CLEANING



Blow-out pump **AB G**

Item	Art.-No.	Sales unit [pcs]
Blow-out pump ABG	089300	1

5 Frame fixings / Stand-off installation

LOADS

Stand-off installation Thermax 12 and 16 with load-bearing anchor rod made of zinc-plated steel 8.8 and a displacement of 1 mm

The below load table is valid for short-term loading (e.g. wind load). If the sealing of the annular gap between Thermax and plaster is assured by fischer all-round sealing KD, the Thermax version with an anchor rod on base substrate side made of zinc-plated steel may be used.

Highest permissible loads^{1) 5) 7)} of a Thermax within an anchor group²⁾ in concrete with the injection mortars FIS V or FIS SB and in masonry with the injection mortar FIS V.

Type	Minimum effective anchorage depth $h_{ef}^{4)8)}$ [mm]	Permissible tensile load $N_{perm}^{3)}$ [kN]	Permissible shear load at $e = 62 \text{ mm}$ $V_{perm}^{3)}$ [kN]	Permissible shear load at $e = 100 \text{ mm}$ $V_{perm}^{3)}$ [kN]	Permissible shear load at $e = 120 \text{ mm}$ $V_{perm}^{3)}$ [kN]	Permissible shear load at $e = 140 \text{ mm}$ $V_{perm}^{3)}$ [kN]	Permissible shear load at $e = 160 \text{ mm}$ $V_{perm}^{3)}$ [kN]	Permissible shear load at $e = 180 \text{ mm}$ $V_{perm}^{3)}$ [kN]	Permissible shear load at $e = 200 \text{ mm}$ $V_{perm}^{3)}$ [kN]	Permissible shear load at $e = 250 \text{ mm}$ $V_{perm}^{3)}$ [kN]	Permissible shear load at $e = 300 \text{ mm}$ $V_{perm}^{3)}$ [kN]	Minimum member thickness h_{min} [mm]	Minimum spacing $s_{min} \parallel / s_{min} \perp$ [mm]	Minimum edge distance c_{min} [mm]
Concrete, cracked and non-cracked, strength class $\geq \text{C20/25}$														
Thermax 12 ⁹⁾	70	3,40 ⁶⁾	1,07	0,69	0,58	0,42	0,32	0,24	0,18	0,08	0,04	100	55	55
Thermax 16 ⁹⁾	80	3,40 ⁶⁾	1,51	0,98	0,83	0,71	0,63	0,48	0,34	0,16	0,08	116	65	65
Solid brick, Mz, EN 771-1; $f_b \geq 12 \text{ N/mm}^2$; $\rho \geq 1,8 \text{ kg/dm}^3$; $LxWxH \geq 240x115x71 \text{ mm}$, NF														
Thermax 12 ⁹⁾	200	2,71	0,85	0,55	0,47	0,40	0,32	0,24	0,18	0,08	0,04	240	80/80	60
Thermax 16 ⁹⁾	200	2,71	1,29	0,98	0,83	0,71	0,63	0,48	0,34	0,16	0,08	240	80/80	60
Solid sand-lime brick, KS, EN 771; $f_b \geq 20 \text{ N/mm}^2$; $\rho \geq 2,0 \text{ kg/dm}^3$; $LxWxH \geq 250x240x240 \text{ mm}$, 8DF														
Thermax 12 ⁹⁾	50	2,86	0,85	0,55	0,47	0,40	0,32	0,24	0,18	0,08	0,04	240	80/80	60
Thermax 16 ⁹⁾	50	2,14	1,51	0,98	0,83	0,71	0,63	0,48	0,34	0,16	0,08	240	80/80	60
Vertically perforated brick type B, HLz, EN 771-1; $f_b \geq 12 \text{ N/mm}^2$; $\rho \geq 1,0 \text{ kg/dm}^3$; $LxWxH = 370x240x237 \text{ mm}$ resp. $500x175x237 \text{ mm}$														
Thermax 12 ⁴⁾	110	1,14	0,57	0,55	0,47	0,40	0,32	0,24	0,18	0,08	0,04	175	100/100	100
Thermax 16 ⁴⁾	110	1,14	0,57	0,57	0,57	0,57	0,48	0,34	0,16	0,08	0,08	175	100/100	100
Perforated sand-lime brick, KSL, EN 771-2; $f_b \geq 12 \text{ N/mm}^2$; $\rho \geq 1,4 \text{ kg/dm}^3$; $LxWxH = 240x175x113 \text{ mm}$, 3DF														
Thermax 12 ⁴⁾	85	1,00	0,85	0,55	0,47	0,40	0,32	0,24	0,18	0,08	0,04	175	100/115	80
Thermax 16 ⁴⁾	85	1,00	1,14	0,98	0,83	0,71	0,63	0,48	0,34	0,16	0,08	175	100/115	80
Hollow block made of light weight concrete, Hbl, EN 771-3; $f_b \geq 2 \text{ N/mm}^2$; $\rho \geq 1,0 \text{ kg/dm}^3$; $LxWxH = 362x240x240 \text{ mm}$														
Thermax 12 ⁴⁾	110	0,43	0,26	0,26	0,26	0,26	0,26	0,24	0,18	0,08	0,04	240	100/240	60
Thermax 16 ⁴⁾	180	0,71	0,26	0,26	0,26	0,26	0,26	0,26	0,26	0,16	0,08	240	100/240	60
Aerated concrete (cylindrical drill hole), EN 771-4; $f_b \geq 2 \text{ N/mm}^2$; $\rho \geq 0,35 \text{ kg/dm}^3$; $LxWxH \geq 599x240x249 \text{ mm}$														
Thermax 12 ⁹⁾	200	1,43	0,43	0,43	0,43	0,40	0,32	0,24	0,18	0,08	0,04	240	80/80	100
Thermax 16 ⁹⁾	200	1,43	0,43	0,43	0,43	0,43	0,43	0,43	0,34	0,16	0,08	240	80/80	100

For the design the complete approval Z-21.8-1837 as well as the European Technical Assessments ETA-10/0383, ETA-02/0024 or ETA-12/0258 have to be considered.

¹⁾ The required partial safety factors for material resistance as well as a partial safety factor for load actions of $\gamma_L = 1,4$ are considered.

²⁾ Set-up of one or more Thermax in a row in direction of shear, for which the clamping of the attachment prevents a torsion on attachment side due to a sufficient stiffness of the attachment or connecting construction. For a clamping on base substrate side only, see approval.

³⁾ For combinations of tensile and shear loads as well as reduced edge distances or spacings (anchor groups) see approval. The values for tensile loads in masonry are valid only, if the joints of the masonry is completely filled with masonry mortar. If the joints are not filled with masonry mortar are not filled with masonry mortar and the edge distance towards the joints is less than c_{min} , the loads have to be reduced by the factor $a_j = 0,75$. The values for shear loads are valid only, if the joints are filled with masonry mortar. For not completely filled joints they have to be handled like a free edge and a minimum edge distance c_{min} of the anchors to the joints has to be observed. For compression loads and perforated bricks or hollow blocks see approval. Calculative assumed thickness of the attachment $t_{fix} = 6 \text{ mm}$.

⁴⁾ In vertically perforated bricks HLz, perforated sand-lime bricks KSL as well as hollow blocks made of light weight concrete Hbl the Thermax 12 (standard version) can bridge non-load bearing layers up to 110 mm and the Thermax 16 can bridge them up to 170 mm. Larger usable lengths up to 300 mm are possible, if other perforated sleeves and where required longer anchor rods are used and again the anchorage depth gets reduced - see approval.

⁵⁾ The stated permissible loads are valid for anchorages in dry base substrates - use category d/d - and for temperatures up to +50 °C (resp. short-term up to +80 °C) in the area of the injection mortar and during drill hole cleaning in accordance with the approval. The load values apply to anchor rods on base substrate side made of zinc-plated steel grade 8.8 - for other steel grades or stainless steel see approval.

⁶⁾ Complies with the permissible tensile load of the Thermax Cone.

⁷⁾ Intermediate values of the shear load may be linearly interpolated in dependence of "e", if nothing else is mentioned in the approval.

⁸⁾ In solid bricks Mz and solid sand-lime bricks KS the Thermax 12 (standard version) can bridge non-load bearing layers up to 190 mm (140 mm in aerated concrete) and the Thermax 16 can bridge them up to 300 mm (270 mm in aerated concrete) - but in solid brick Mz and aerated concrete the above load values have to be reduced. In concrete the Thermax 12 (standard version) can bridge non-loadbearing layers up to 170 mm and the Thermax 16 can bridge them up to 290 mm. Larger usable lengths up to 300 mm are possible, if longer anchor rods are used and again in solid bricks Mz if the anchorage depth (compared to above values) gets reduced where required - see approval.

⁹⁾ Minimum spacings for at the same time reduced permissible loads, where required.

LOADS

Stand-off installation Thermax 12 and 16 with load-bearing anchor rod made of stainless steel A4-70 and a displacement of 3 mm

The below load table is valid for short-term loading (e.g. wind load). Measures for sealing see approval, section 3.2.4.

Highest permissible loads^{1) 5) 7)} of a Thermax within an anchor group²⁾ in concrete with the injection mortars FIS V or FIS SB and in masonry with the injection mortar FIS V.

Type	Minimum effective anchorage depth $h_{ef}^{4)8)}$ [mm]	Permissible tensile load $N_{perm}^{3)}$ [kN]	Permissible shear load at $e = 62$ mm $V_{perm}^{3)}$ [kN]	Permissible shear load at $e = 100$ mm $V_{perm}^{3)}$ [kN]	Permissible shear load at $e = 120$ mm $V_{perm}^{3)}$ [kN]	Permissible shear load at $e = 140$ mm $V_{perm}^{3)}$ [kN]	Permissible shear load at $e = 160$ mm $V_{perm}^{3)}$ [kN]	Permissible shear load at $e = 180$ mm $V_{perm}^{3)}$ [kN]	Permissible shear load at $e = 200$ mm $V_{perm}^{3)}$ [kN]	Permissible shear load at $e = 250$ mm $V_{perm}^{3)}$ [kN]	Permissible shear load at $e = 300$ mm $V_{perm}^{3)}$ [kN]	Minimum member thickness h_{min} [mm]	Minimum spacing $s_{min} \parallel / \perp$ [mm]	Minimum edge distance c_{min} [mm]
Concrete, cracked and non-cracked, strength class $\geq C20/25$														
Thermax 12 ⁹⁾	70	3,40 ⁶⁾	1,07	0,69	0,58	0,50	0,44	0,39	0,35	0,24	0,12	100	55	55
Thermax 16 ⁹⁾	80	3,40 ⁶⁾	1,51	0,98	0,83	0,71	0,63	0,56	0,51	0,41	0,24	116	65	65
Solid brick, Mz, EN 771-1; $f_b \geq 12$ N/mm²; $\rho \geq 1,8$ kg/dm³; $LxWxH \geq 240x115x71$ mm, NF														
Thermax 12 ⁹⁾	200	2,71	0,59	0,39	0,33	0,28	0,25	0,22	0,20	0,16	0,12	240	80/80	60
Thermax 16 ⁹⁾	200	2,71	1,29	0,96	0,81	0,70	0,62	0,56	0,50	0,41	0,24	240	80/80	60
Solid sand-lime brick, KS, EN 771; $f_b \geq 20$ N/mm²; $\rho \geq 2,0$ kg/dm³; $LxWxH \geq 250x240x240$ mm, 8DF														
Thermax 12 ⁹⁾	50	2,86	0,59	0,39	0,33	0,28	0,25	0,22	0,20	0,16	0,12	240	80/80	60
Thermax 16 ⁹⁾	50	2,14	1,46	0,96	0,81	0,70	0,62	0,56	0,50	0,41	0,24	240	80/80	60
Vertically perforated brick type B, HLz, EN 771-1; $f_b \geq 12$ N/mm²; $\rho \geq 1,0$ kg/dm³; $LxWxH = 370x240x237$ mm resp. $500x175x237$ mm														
Thermax 12 ⁴⁾	110	1,14	0,57	0,39	0,33	0,28	0,25	0,22	0,20	0,16	0,12	175	100/100	100
Thermax 16 ⁴⁾	110	1,14	0,57	0,57	0,57	0,57	0,57	0,56	0,50	0,41	0,24	175	100/100	100
Perforated sand-lime brick, KSL, EN 771-2; $f_b \geq 12$ N/mm²; $\rho \geq 1,4$ kg/dm³; $LxWxH = 240x175x113$ mm, 3DF														
Thermax 12 ⁴⁾	85	1,00	0,59	0,39	0,33	0,28	0,25	0,22	0,20	0,16	0,12	175	100/115	80
Thermax 16 ⁴⁾	85	1,00	1,14	0,96	0,81	0,70	0,62	0,56	0,50	0,41	0,24	175	100/115	80
Hollow block made of light weight concrete, Hbl, EN 771-3; $f_b \geq 2$ N/mm²; $\rho \geq 1,0$ kg/dm³; $LxWxH = 362x240x240$ mm														
Thermax 12 ⁴⁾	110	0,43	0,26	0,26	0,26	0,26	0,25	0,22	0,20	0,16	0,12	240	100/240	60
Thermax 16 ⁴⁾	180	0,71	0,26	0,26	0,26	0,26	0,26	0,26	0,26	0,26	0,24	240	100/240	60
Aerated concrete (cylindrical drill hole), EN 771-4; $f_b \geq 2$ N/mm²; $\rho \geq 0,35$ kg/dm³; $LxWxH \geq 599x240x249$ mm														
Thermax 12 ⁹⁾	200	1,43	0,43	0,39	0,33	0,28	0,25	0,22	0,20	0,16	0,12	240	80/80	100
Thermax 16 ⁹⁾	200	1,43	0,43	0,43	0,43	0,43	0,43	0,43	0,43	0,41	0,24	240	80/80	100

For the design the complete approval Z-21.8-1837 as well as the European Technical Assessments ETA-10/0383, ETA-02/0024 or ETA-12/0258 have to be considered.

- ¹⁾ The required partial safety factors for material resistance as well as a partial safety factor for load actions of $\gamma_L = 1,4$ are considered.
- ²⁾ Set-up of one or more Thermax in a row in direction of shear, for which the clamping of the attachment prevents a torsion on attachment side due to a sufficient stiffness of the attachment or connecting construction. For a clamping on base substrate side only, see approval.
- ³⁾ For combinations of tensile and shear loads as well as reduced edge distances or spacings (anchor groups) see approval. The values for tensile loads in masonry are valid only, if the joints of the masonry is completely filled with masonry mortar. If the joints are not filled with masonry mortar are not filled with masonry mortar and the edge distance towards the joints is less than c_{min} , the loads have to be reduced by the factor $a_j = 0,75$. The values for shear loads are valid only, if the joints are filled with masonry mortar. For not completely filled joints they have to be handled like a free edge and a minimum edge distance c_{min} of the anchors to the joints has to be observed. For compression loads and perforated bricks or hollow blocks see approval. Calculative assumed thickness of the attachment $t_{fix} = 6$ mm.
- ⁴⁾ In vertically perforated bricks HLz, perforated sand-lime bricks KSL as well as hollow blocks made of light weight concrete Hbl the Thermax 12 (standard version) can bridge non-load bearing layers up to 110 mm and the Thermax 16 can bridge them up to 170 mm. Larger usable lengths up to 300 mm are possible, if other perforated sleeves and where required longer anchor rods are used and again the anchorage depth gets reduced - see approval.
- ⁵⁾ The stated permissible loads are valid for anchorages in dry base substrates - use category d/d - and for temperatures up to +50 °C (resp. short-term up to +80 °C) in the area of the injection mortar and during drill hole cleaning in accordance with the approval. The load values apply to anchor rods on base substrate side made of stainless steel of the grade A4-70.
- ⁶⁾ Complies with the permissible tensile load of the Thermax Cone.
- ⁷⁾ Intermediate values of the shear load may be linearly interpolated in dependence of "e", if nothing else is mentioned in the approval.
- ⁸⁾ In solid bricks Mz and solid sand-lime bricks KS the Thermax 12 (standard version) can bridge non-load bearing layers up to 190 mm (140 mm in aerated concrete) and the Thermax 16 can bridge them up to 300 mm (270 mm in aerated concrete) - but in solid brick Mz and aerated concrete the above load values have to be reduced. In concrete the Thermax 12 (standard version) can bridge non-loadbearing layers up to 170 mm and the Thermax 16 can bridge them up to 290 mm. Larger usable lengths up to 300 mm are possible, if longer anchor rods are used and again in solid bricks Mz if the anchorage depth (compared to above values) gets reduced where required - see approval.
- ⁹⁾ Minimum spacings for at the same time reduced permissible loads, where required.

The quick façade repair for two-leaf cavity walls



Facing masonry



Repairing outer leaves

VERSIONS

- Zinc-plated steel
- Stainless steel

BUILDING MATERIALS

- Facing masonry with and without an air layer

CERTIFICATES



ADVANTAGES

- The approved fixing in stone and in joints from at least 50 mm facing masonry provides a high degree of flexibility and security.
- Use in joints and with a low anchorage depth of just 50 mm allows for a quick and economical installation.
- The small anchor rim and screw head allow for a surface-flush or deep-set installation.
- The drill hole can be retrospectively sealed so that it is no longer visible in the façade.
- A drip coil prevents condensate running into the load-bearing layer, thus preventing frost and corrosive damage.

APPLICATIONS

- VBS-M is especially suitable for applications where external thermal insulation composite systems (ETICS) have been previously installed.
- Retrospective repair of facing masonry.

FUNCTIONING

- The remedial wall tie VBS-M is set in the load-bearing layer and into facing masonry using push-through installation.
- In accordance with the approval, no drill hole cleaning is required.
- The two expansion zones in the load-bearing layer and in the facing masonry ensure a secure fixation.
- The plug doesn't fix into the facing masonry until the head grips into the load-bearing layer. This ensures the very best installation safety.

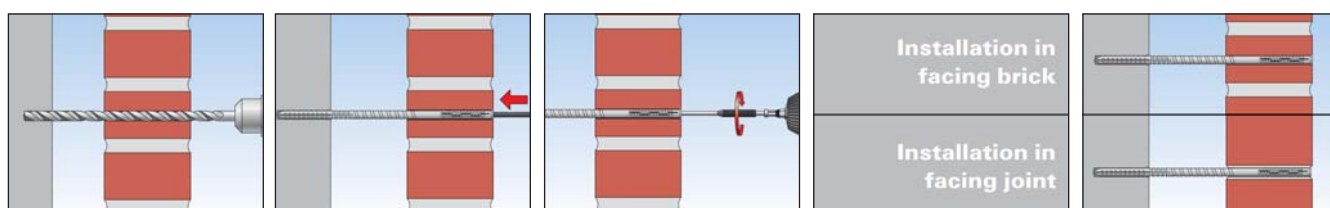

TECHNICAL DATA



Remedial wall tie **VBS-M**

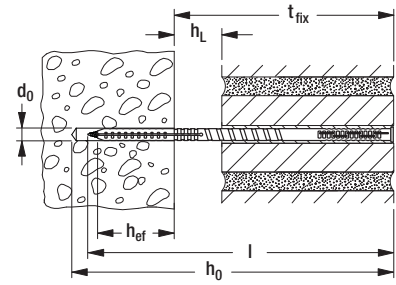

	Zinc-plated steel	Stainless steel	Max. shell distance at 115 mm facing masonry, flush installation	Max. shell distance at 115 mm facing masonry, 20 mm sunk installation	Facing masonry + cavity	Drill diameter	Drill hole depth	Effect. anchorage depth	Anchor length	Sales unit
	Art.-No.	Art.-No.	[mm]	[mm]	t _{fix} [mm]	d ₀ [mm]	h ₀ [mm]	h _{ef} [mm]	l [mm]	[pcs]
Item	gvz	A4								
VBS-M 8 x 120	514243	514236	20*	—	70	8	140	>50	120	100
VBS-M 8 x 185	514244	514237	20	40	135	8	205	>50	185	100
VBS-M 8 x 205	514245	514238	40	60	155	8	225	>50	205	100
VBS-M 8 x 225	514246	514239	60	80	175	8	245	>50	225	100
VBS-M 8 x 245	514247	514240	80	100	195	8	265	>50	245	100
VBS-M 8 x 265	514248	514241	100	120	215	8	285	>50	265	100
VBS-M 8 x 285	514249	514242	120	140	235	8	305	>50	285	100

* Max. 20 mm mortar layer in the case of 50 mm thick economy facing.

The drill hole depth is to be adapted accordingly in the case of sunk installation of the anchor.

ACCESSORIES / DRILLS



Item	Art.-No.	Description	Sales unit [pcs]
SDS Plus IV 8/100/400	517689	fischer Quattric drill bit with SDS fixture and short flute for drilling in concrete	1
Masonry drill bit 8/100/400	517690	fischer masonry drill bit with SDS fixture and short flute, ground sharp, for rotary drilling in perforated brick and in the bed joint	1
SDS Plus II 8/400/460	531785	fischer hammer drill bit for drilling in concrete and in the facing brick	1

ACCESSORIES / BITS



Item	Art.-No.	Description	Sales unit [pcs]
FPB TX 25/5 long	517693	fischer Profi-Bit long, which can be extended to 50 mm bit, allows for deep setting in stone and in the bed joint	12
FPB T 25 PROFI Bit W 10	533115	fischer Profi-Bit	10

Frame fixings / Stand-off installation 5





6 General fixings

		Page
DUOPOWER		348
Universal plug UX		351
Universal plug UX GREEN		356
Expansion plug SX		358
Expansion plug SX GREEN		361
Expansion plug S		363
Threaded rod plug RODFORCE FGD		366
Metal expansion anchor FMD		368
Expansion plug M-S		370
Anchor M		372
Brass fixing MS		374
Aircrete anchor GB		376
Aircrete anchor GB GREEN		378
Turbo aircrete anchor FTP K		380
Turbo aircrete anchor FTP M		382
Brass fixing PA 4		384
Balcony cladding fixing P 9 K		386
Stair-tread fixing TB / TBB		388
Repair pad FIX.it		389
Doorstop TS		390

The duo of power and intelligence

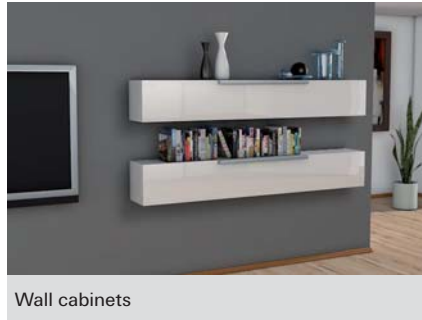

Wall cabinets



TV-brackets

General fixings 6

BUILDING MATERIALS

- Concrete
- Solid brick
- Solid sand-lime brick
- Aerated concrete
- Vertically perforated brick
- Perforated sand-lime brick
- Plasterboard
- Gypsum plasterboard and gypsum fibreboards
- Hollow blocks made from lightweight concrete
- Cavity floor slabs made from bricks and concrete or similar
- Natural stone
- Chipboard
- Solid panel made from gypsum
- Solid brick made from lightweight concrete

CERTIFICATES



ADVANTAGES

- Two component materials for top load values and intelligent functioning (expansion, folding, knotting), depending on building material - solid, perforated or panel material.
- Great feedback (feel-good-factor) of the plug. You can feel exactly when the plug is installed perfectly.
- The narrow plug rim prevents slipping into the drill hole.
- The serrated anti-rotation feature interlock in the building material and prevents rotation in the drill hole during installation.
- The greater anchorage depth of the DUOPOWER 6 x 50, 8 x 65 and 10 x 80 means that the plug is especially suited to fixings in hollow building materials, aerated concrete and to bridge plaster.

APPLICATIONS

- TV consoles
- Lighting
- Shelves
- Mirror cabinets
- Letter boxes
- Pictures
- Fixing blinds
- Curtain rails
- Wash basin fixings
- Plumbing and heating fixings
- Bath and toilet installations
- Wall cabinets
- Range hood

FUNCTIONING

- The grey component made from high quality nylon automatically activates for the optimum product function (expansion, folding, knotting) for the best hold.
- The red expansion wings support the safe expansion and offer additional safety for the grey component.
- The smooth-running opening allows the simple positioning of the screw and the secure guiding and fixing in the screw channel.
- The required screw length is given by the plug length + fixture thickness + the screw diameter.
- Suitable for wood and chipboard screws, as well as stud screws.
- In the case of fixing boards, the threadless part of the screw must not be longer than the fixture.

INSTALLATION IN SOLID BUILDING MATERIALS

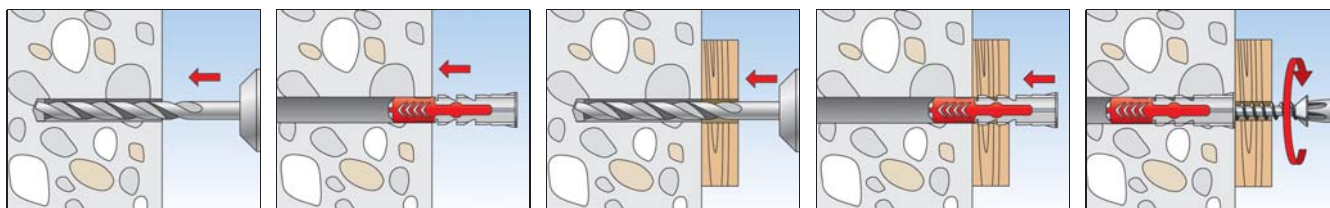

INSTALLATION IN HOLLOW BUILDING MATERIALS

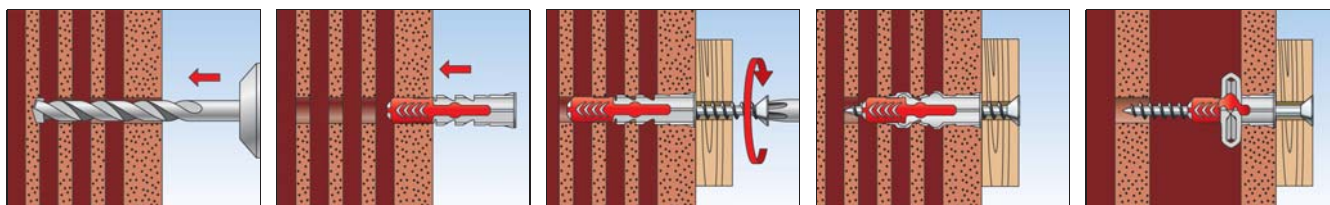

INSTALLATION IN PANEL BUILDING MATERIALS

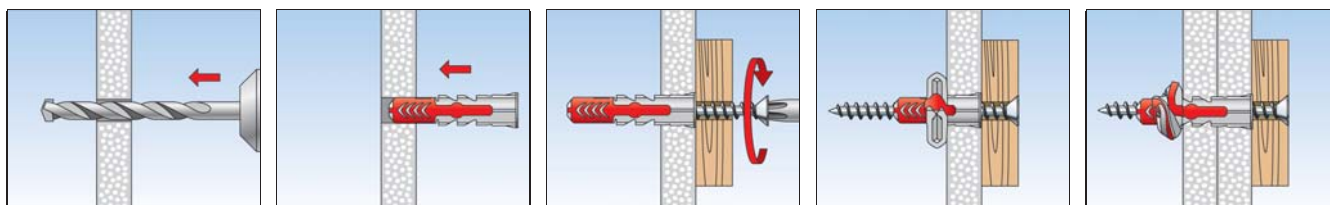

TECHNICAL DATA



DUOPOWER



DUOPOWER with greater anchorage depth

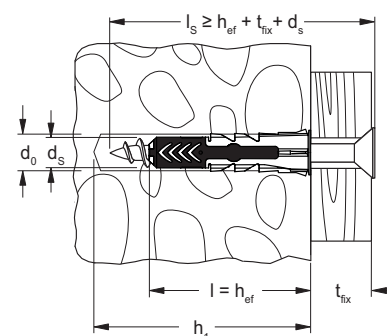

Item	Art.-No. without screw	Art.-No. with screw	Drill hole diameter	Min. drill hole depth	Min. panel thickness	Min. bolt penetra- tion	Anchor length	Wood and chipboard screws	Drive	Max. fixture thickness	Sales unit
			d ₀ [mm]	h ₁ [mm]	d _p [mm]	l _{E,min} [mm]	l [mm]	d _s / d _s x l _s [mm]			
DUOPOWER 5 x 25	555005	—	5	35	12,5	29	25	3 - 4	—	—	100
DUOPOWER 6 x 30	555006	—	6	40	12,5	35	30	4 - 5	—	—	100
DUOPOWER 6 x 50	538240	—	6	60	12,5	55	50	4 - 5	—	—	100
DUOPOWER 8 x 40	555008	—	8	50	12,5	46	40	4,5 - 6	—	—	100
DUOPOWER 8 x 65	538241	—	8	75	2 x 12,5	71	65	4,5 - 6	—	—	50
DUOPOWER 10 x 50	555010	—	10	70	12,5	58	50	6 - 8	—	—	50
DUOPOWER 10 x 80	538242	—	10	100	—	88	80	6 - 8	—	—	25
DUOPOWER 12 x 60	538243	—	12	80	—	70	60	8 - 10	—	—	25
DUOPOWER 14 x 70	538244	—	14	90	—	82	70	10 - 12	—	—	20
DUOPOWER 5 x 25 S	—	555105	5	40	12,5	29	25	4 x 35	PZ2	6	50
DUOPOWER 6 x 30 S	—	555106	6	45	12,5	35	30	4,5 x 40	PZ2	5	50
DUOPOWER 6 x 50 S	—	538245	6	75	12,5	55	50	4,5 x 70	PZ2	15	50
DUOPOWER 8 x 40 S	—	555108	8	65	12,5	45	40	5 x 60	PZ2	15	50
DUOPOWER 8 x 65 S	—	538246	8	85	2 x 12,5	70	65	5 x 80	PZ2	10	25
DUOPOWER 10 x 50 S	—	555110	10	74	12,5	57	50	7 x 69	SW 13 / TX 40	13	25
DUOPOWER 10 x 80 S	—	538247	10	112	—	87	80	7 x 107	SW 13	20	10

TECHNICAL DATA



DUOPOWER



DUOPOWER with greater anchorage depth

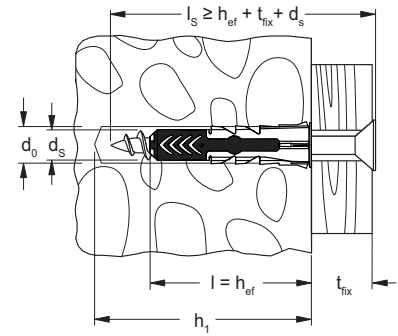

General fixings 6

Item	Art.-No. without screw	Art.-No. with screw	Drill hole diameter	Min. drill hole depth	Min. panel thickness	Min. bolt penetration	Anchor length	Wood and chipboard screws	Drive	Max. fixture thickness	Sales unit
			d_0 [mm]	h_1 [mm]	d_p [mm]	$l_{E,min}$ [mm]	l [mm]	$d_s / d_s \times l_s$ [mm]	t_{fix} [mm]	[pcs]	
DUOPOWER 12 x 60 S	—	538248	12	85	—	68	60	8 x 80	SW 13	12	10
DUOPOWER 14 x 70 S	—	538249	14	100	—	80	70	10 x 95	SW 17	15	8

LOADS

DUOPOWER

Highest recommended loads¹⁾ for a single anchor.

The given loads are valid for wood screws with the specified diameter.

Type	DUOPOWER										
	5 x 25	6 x 30	6 x 50	8 x 40	8 x 65	10 x 50	10 x 80	12 x 60	14 x 70		
Wood screw diameter	\emptyset [mm]	4	5	5	6	6	8	8	10	12	
Min. edge distance concrete	c_{min} [mm]	30	35	35	50	50	65	65	80	100	
Recommended loads in the respective base material F_{rec}²⁾											
Concrete	$\geq C20/25$ [kN]	0,40	0,95	1,65	1,10	2,30	2,15	4,20	3,30	5,30	
Solid brick	$\geq Mz 12$ [kN]	0,30	0,50	0,55	0,62	0,69	1,20	1,45	1,30	1,35	
Solid sand-lime brick	$\geq KS 12$ [kN]	0,50	1,00	1,60	1,25	2,25	2,20	3,85	2,80	4,50	
Aerated concrete	$\geq PB 2, PP 2 (G 2)$ [kN]	0,05	0,10	0,15	0,10	0,16	0,20	0,30	0,24	0,35	
Aerated concrete	$\geq PB 4, PP 4 (G 4)$ [kN]	0,25	0,38	0,55	0,42	0,60	0,60	1,10	1,00	1,45	
Vertically perforated brick	$\geq Hlz 12 (\rho \geq 0,9 \text{ kg/dm}^3)$ [kN]	0,13	0,15	0,17	0,25	0,40	0,25	0,40	0,35	0,40	
Perforated sand-lime brick	$\geq KSL 12 (\rho \geq 1,6 \text{ kg/dm}^3)$ [kN]	0,40	0,60	0,60	0,70	1,00	0,70	2,00	0,75	1,50	
Gypsum block	$(\rho \geq 0,9 \text{ kg/dm}^3)$ [kN]	0,10	0,18	0,37	0,25	0,50	0,35	0,65	0,50	0,50	
Gypsum fibreboard	12,5 mm [kN]	0,24	0,33	0,35	0,35	-	0,50	-	-	-	
Gypsum plasterboard	12,5 mm [kN]	0,12	0,15	0,15	0,15	-	0,15	-	-	-	
Gypsum plasterboard	2 x 12,5 mm [kN]	0,13	0,15	0,24	0,20	0,32	0,30	-	-	-	
Mattone Forato Typ F8	[kN]	0,30	0,30	-	0,25	-	0,25	-	-	-	
Tramezza Doppio UNI 19	[kN]	0,15	0,15	0,23	0,15	0,30	0,20	0,52	0,35	0,35	
Sepa Parpaing	[kN]	0,30	0,45	0,25 ³⁾	0,45	0,45 ³⁾	0,45	0,45 ³⁾	0,60 ³⁾	0,60 ³⁾	

¹⁾ Required safety factors are considered.

²⁾ The load data are valid for tension, shear and combined tension and shear load.

³⁾ Load determination on plastered wall.

The nylon plug for all building materials

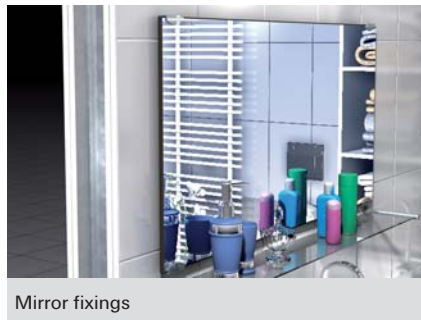

BUILDING MATERIALS

- Concrete
- Gypsum plasterboard and gypsum fibreboards
- Vertically perforated brick
- Hollow blocks made from lightweight concrete
- Cavity floor slabs made from bricks and concrete
- Perforated sand-lime brick
- Solid sand-lime brick
- Natural stone
- Aerated concrete
- Chipboard
- Solid panel made from gypsum
- Solid brick made from lightweight concrete
- Solid brick

CERTIFICATES



ADVANTAGES

- The universal operating principle (knotting or expanding) allows for use in all solid, hollow and board building materials. Thus the UX is the correct choice for unknown base materials.
- The UX's angled connection ridges allow for optimum screw guidance. Serrated anti-rotation locks prevent rotation in the drill hole. This guarantees the greatest possible installation safety.
- Fixing sets with screws, eye screws and hooks provide the right solution for all applications.

APPLICATIONS

- Pictures
- Lighting
- Skirting
- Light cabinets
- Towel rails
- Mirror cabinets
- Curtain rails
- Wash basin fixings
- TV consoles
- Plumbing and heating fixings

FUNCTIONING

- The UX with rim is suitable for pre-positioned installation; the UX without rim is suitable for push-through installation.
- Turning in the screw causes the UX to expand in the solid building material and to knot within the cavity.
- The required screw length is given by the plug length + fixture thickness + 1 x screw diameter.
- Suitable for wood and chipboard screws, as well as stud screws.
- In the case of board building materials, the threadless part of the screw must not be longer than the fixture, and the UX with rim is to be used.
- The edge distance must be at least one plug length.

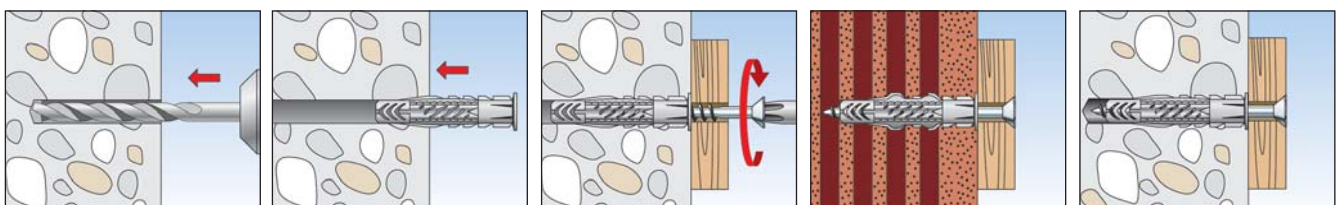

TECHNICAL DATA



UX - without rim



UX - with collar



UX R S - with rim and screw

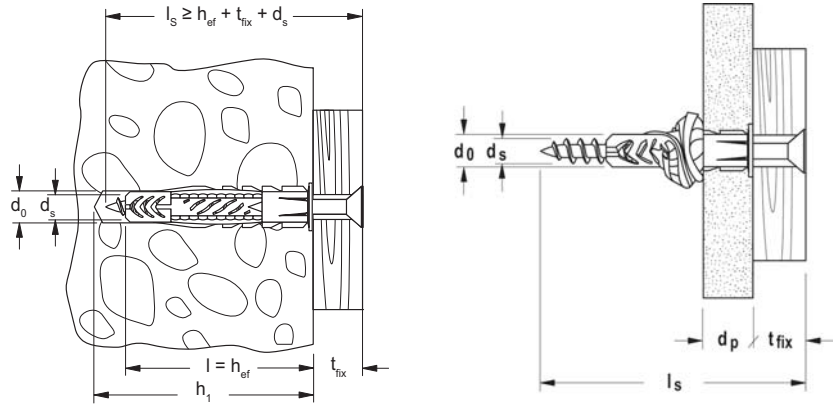

6 General fixings

	Without rim	With rim	With rim and screw	Drill hole diameter d_0 [mm]	Min. drill hole depth h_1 [mm]	Min. panel thickness d_p [mm]	Anchor length l [mm]	Wood and chip-board screws $d_s / d_s \times l_s$ [mm]	Max. fixture thickness t_{fix} [mm]	Sales unit [pcs]
Item	Art.-No. UX	Art.-No. UX R	Art.-No. UX R S							
UX 5 x 30	094721	094722	—	5	40	9,5	30	3 - 4	—	100
UX 6 x 35	062754	062756	—	6	45	9,5	35	4 - 5	—	100
UX 6 x 35	—	—	094758	6	65	9,5	35	4,5 x 60	20	25
UX 6 x 50	072094	072095	—	6	60	9,5	50	4 - 5	—	100
UX 6 x 50	—	—	094759	6	80	9,5	50	4,5 x 75	20	25
UX 8 x 40	—	505483	—	8	50	9,5	40	4,5 - 6	—	100
UX 8 x 50	077869	077870	—	8	60	9,5	50	4,5 - 6	—	100
UX 8 x 50	—	—	094762	8	75	9,5	50	5 x 70	15	25
UX 8 x 50	—	—	094760	8	85	9,5	50	5 x 80	25	25
UX 10 x 60	077871	077872	—	10	75	12,5	60	6 - 8	—	50
UX 10 x 60	094761 ¹⁾	—	—	10	90	12,5	60	6 x 85	20	10
UX 12 x 70	062758	—	—	12	85	—	70	8 - 10	—	25
UX 14 x 75	062757	—	—	14	95	—	75	10 - 12	—	20

1) with screw

TECHNICAL DATA



UX RH - with rim and round hook



UX WH - with rim and angle hook

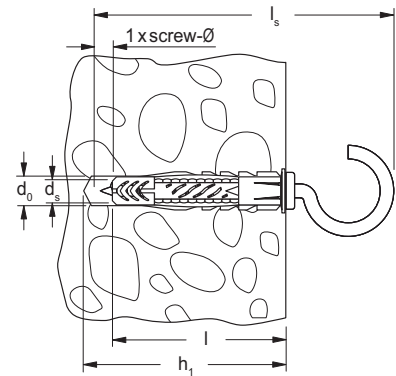

UX RH N - with rim and round hook (white coated)



UX WH N - with rim and angle hook (white coated)



UX OH N - with rim and eyebolt (white coated)

	With rim and round hook	With round hook (white coated)	With rim and angle hook	With angle hook (white coated)	With eyebolt (white coated)	Drill hole diameter d_0 [mm]	Min. drill hole depth h_1 [mm]	Min. panel thickness d_p [mm]	Anchor length l [mm]	Screw dimension $d_s \times l_s$ [Ø mm]	Sales unit [pcs]
Item	RH	RH N	WH	WH N	OH N						
UX 6 x 35	094407	—	—	—	—	6	45	9,5	35	4,5 x 67	25
UX 6 x 35	—	—	094408	—	—	6	45	9,5	35	4,5 x 51	25
UX 8 x 50	094409	094412	—	—	094414	8	60	9,5	50	5,5 x 87	25
UX 8 x 50	—	—	094410	094413	—	8	60	9,5	50	5,5 x 70	25

TECHNICAL DATA



UX in bucket

Item	Art.-No.	Drill hole diameter d_0 [mm]	Min. drill hole depth h_1 [mm]	Min. panel thickness d_p [mm]	Fixing length l [mm]	Wood and chipboard screws $d_s / d_s \times l_s$ [mm]	Sales unit [pcs]
UX 6 x 35 R in bucket	508027	6	45	9,5	35	4 - 5	2500
UX 8 x 50 R in bucket	508028	8	60	9,5	50	4,5 - 6	1000
UX 10 x 60 R in bucket	508029	10	75	12,5	60	6 - 8	600

TECHNICAL DATA



Assortment box UX / SX

Box UX / SX-S

Meister-Box

Item	Art.-No.	Contents	Sales unit [pcs]
Box UX 6/8/10	093182	100 plugs UX 6 x 35, 70 plugs UX 8 x 50, 20 plugs UX 10 x 60	1
Box UX-R 6/8/10	093819	100 plugs UX 6 x 35 R, 70 plugs UX 8 x 50 R, 20 plugs UX 10 x 60 R	1
Box UX / SX-S	093181	50 plugs UX 6 x 35, 50 screws 4,5 x 50, 50 plugs SX 6 x 30, 50 screws 4,5 x 45, 25 plugs UX 8 x 50, 25 screws 5 x 65, 25 plugs SX 8 x 40, 25 screws 5 x 50	1
Assortment box UX / SX	040991	60 plugs SX 6 x 30, 50 plugs SX 8 x 40, 20 plugs SX 10 x 50, 60 plugs UX 5 x 30 R, 40 plugs UX 6 x 50 R, 50 plugs UX 8 x 50 R, 10 plugs UX 10 x 60 R	1
Profi-Box UX + screws + hooks	518526	International version: 50 Universal plugs UX 6 x 35 R, 25 Universal plugs UX 8 x 50 R, 20 Chipboard screws 4,5 x 60, 15 Chipboard screws 5 x 70, 4 Angle hooks 5,5, x 70, 4 Round hooks 5,5 x 80	1
Profi-Box UX / UX-R	518527	International version: 25 Universal plugs UX 6 x 35, 25 Universal plugs UX 6 x 35 R, 25 Universal plugs UX 8 x 50, 25 Universal plugs UX 8 x 50 R, 10 Universal plugs UX 10 x 60	1
Meister-Box UX + screws + hooks	513894	German version: 50 Universal plugs UX 6 x 35 R, 25 Universal plugs UX 8 x 50 R, 20 Chipboard screws 4,5 x 60, 15 Chipboard screws 5 x 70, 4 Angle hooks 5,5, x 70, 4 Round hooks 5,5 x 80	1
Meister-Box UX / UX-R	513893	German version: 25 Universal plugs UX 6 x 35, 25 Universal plugs UX 6 x 35 R, 25 Universal plugs UX 8 x 50, 25 Universal plugs UX 8 x 50 R, 10 Universal plugs UX 10 x 60	1

LOADS

Universal plug UX

Highest recommended tensile loads¹⁾ for a single anchor.

The given loads are valid for wood screws with the specified diameter.

Type			UX 5 x 30	UX 6 x 35	UX 6 x 50	UX 8 x 40 UX 8 x 50	UX 10 x 60	UX 12 x 70	UX 14 x 75
Wood screw diameter	∅ [mm]		4	5	5	6	8	10	12
Recommended loads in the respective base material F_{rec}²⁾									
Concrete	≥ C20/25	[kN]	0,30	0,40	0,60	0,60	1,00	1,50	1,80
Solid brick	≥ Mz 12	[kN]	0,20	0,20	0,30	0,30	0,50	0,70	0,80
Perforated sand-lime brick	≥ KSL 12	[kN]	0,30	0,40	0,40	0,50	0,60	0,80	0,80
Vertically perforated brick	≥ Hlz 12	[kN]	0,20	0,20	0,20	0,20	0,20	0,30	0,40
Aerated concrete	≥ AAC 4	[kN]	0,15	0,20	0,20	0,30	0,40	0,60	0,70
Gypsum plasterboard	12,5 mm	[kN]	0,10	0,10	0,10	0,10	0,10	-	-
Gypsum plasterboard	25 mm	[kN]	0,10	0,15	0,15	0,15	0,15	-	-
Gypsum fibreboard	(Fermacell)	[kN]	0,20	0,20	0,20	0,20	0,25	-	-
Gypsum block	ρ ≥ 0,9 kg/dm ³	[kN]	-	-	-	0,15	0,35	0,45	0,50

¹⁾ Required safety factors are considered.

²⁾ Valid for tensile load, shear load and oblique load under any angle.

LOADS

Universal plug UX with hook screws respective eye screws

Highest recommended tensile loads¹⁾ for a single anchor.

The given loads are valid for the included hook screws respective eye screws.

Type			UX 6 x 35 RH	UX 6 x 35 WH	UX 8 x 50 RH	UX 8 x 50 WH	UX 8 x 50 OE
Recommended loads in the respective base material F_{rec}²⁾							
Concrete	≥ C20/25	[kN]	0,25	0,30	0,40	0,45	0,40
Vertically perforated brick	≥ Hlz 12	[kN]	0,20	0,20	0,20	0,20	0,20
Gypsum plasterboard	12,5 mm	[kN]	0,05	0,05	0,05	0,05	0,05

¹⁾ Required safety factors are considered.

²⁾ Valid for tensile load, shear load and oblique load under any angle.

The nylon plug for all building materials



Curtain rails



Shelves

6
General fixings

BUILDING MATERIALS

- Concrete
- Gypsum plasterboard and gypsum fibreboards
- Vertically perforated brick
- Hollow blocks made from lightweight concrete
- Cavity floor slabs made from bricks and concrete
- Perforated sand-lime brick
- Solid sand-lime brick
- Natural stone
- Aerated concrete
- Chipboard
- Solid panel made from gypsum
- Solid brick made from lightweight concrete
- Solid brick

CERTIFICATES



ADVANTAGES

- Produced with at least 50% renewable raw materials and therefore particularly environmentally friendly.
- Just as effective, secure and durable as regular UX plugs.
- The universal operating principle (knotting or expanding) allows for use in all solid, hollow and board building materials. Thus the UX GREEN is the correct choice for unknown base materials.
- Plug collar for anti-slip safety and saw tooth sides as turning lock ensure the highest installation safety.

APPLICATIONS

- Pictures
- Lighting
- Skirting
- Light cabinets
- Towel rails
- Mirror cabinets
- Curtain rails
- Wash basin fixings
- TV consoles
- Plumbing and heating fixings

FUNCTIONING

- The Universal plug UX with rim is suitable for pre-positioned installation; the UX without rim is suitable for push-through installation.
- When screwing in the screw, the UX GREEN expands in solid building materials and knots itself into cavities.
- Suitable for wood and chipboard screws, as well as stud screws.
- The required screw length is given by: the plug length + fixture thickness + 1 x screw diameter.
- In the case of board building materials, the threadless part of the screw must not be longer than the fixture.
- The edge distance must be at least one plug length.

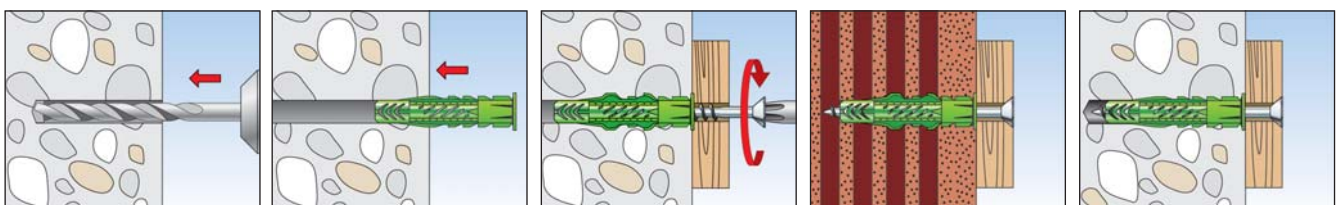

TECHNICAL DATA

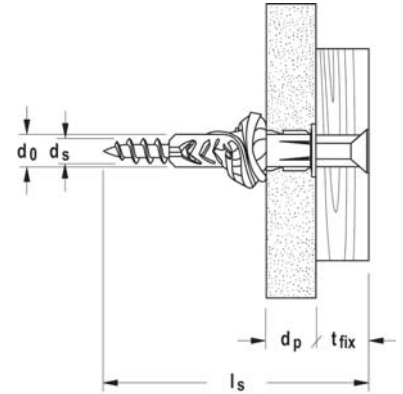
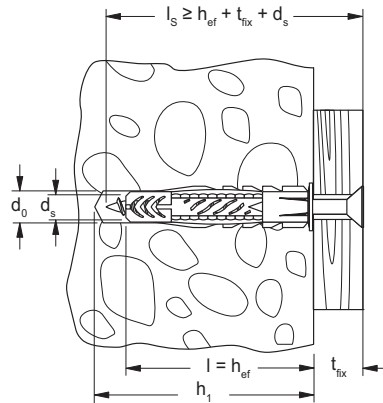

Universal plug **UX GREEN R** - with rim

	With rim	Without rim	Drill hole diameter	Min. drill hole depth	Min. panel thickness	Anchor length	Wood and chip-board screws	Sales unit
	Art.-No.	Art.-No.	d_0 [mm]	h_1 [mm]	d_p [mm]	l [mm]	$d_s / d_s \times l_s$ [mm]	[pcs]
Item	UX R	UX						
UX GREEN 6 x 35	518885	—	6	45	9,5	35	4 - 5	40
UX GREEN 6 x 50	524855	—	6	60	9,5	50	4 - 5	40
UX GREEN 8 x 50	518886	—	8	60	9,5	50	4,5 - 6	40
UX GREEN 10 x 60	518887	—	10	75	12,5	60	6 - 8	20
UX GREEN 12 x 70	—	524858	12	85	—	70	8 - 10	18

LOADS

Universal plug UX GREEN

Highest recommended loads¹⁾ for a single anchor.

The given loads are valid for wood screws with the specified diameter.

Type			UX GREEN 6 x 35	UX GREEN 6 x 50	UX GREEN 8 x 50	UX GREEN 10 x 60	UX GREEN 12 x 70
Screw diameter	\emptyset	[mm]	5	5	6	8	10
Recommended loads in the respective base material F_{rec}²⁾							
Concrete	\geq C20/25	[kN]	0,40	0,60	0,60	1,00	1,50
Solid brick	\geq Mz 12	[kN]	0,20	0,30	0,30	0,50	0,70
Perforated sand-lime brick	\geq KSL 12	[kN]	0,40	0,40	0,50	0,60	0,80
Vertically perforated brick	\geq Hlz 12	[kN]	0,20	0,20	0,20	0,20	0,30
Aerated concrete	\geq AAC 4	[kN]	0,20	0,20	0,30	0,40	0,60
Gypsum plasterboard	12,5 mm	[kN]	0,10	0,10	0,10	0,10	-
Gypsum plasterboard	25 mm	[kN]	0,15	0,15	0,15	0,15	-
Gypsum fibreboard	(Fermacell)	[kN]	0,20	0,20	0,20	0,25	-
Gypsum block	$\rho \geq 0,9 \text{ kg/dm}^3$	[kN]	-	-	0,15	0,35	0,45

¹⁾ Required safety factors are considered.

²⁾ Valid for tensile load, shear load and oblique load under any angle.

The powerful nylon plug with 4-way expansion



Wall consoles



Curtain rails

General fixings 6

BUILDING MATERIALS

- Concrete
- Vertically perforated brick
- Hollow blocks made from lightweight concrete
- Cavity floor slabs made from bricks and concrete
- Perforated sand-lime brick
- Solid sand-lime brick
- Natural stone with dense structure
- Aerated concrete
- Solid panel made from gypsum
- Solid brick made from lightweight concrete
- Solid brick

CERTIFICATES



ADVANTAGES

- The 4-way expansion provides the optimum force distribution in the material, and offers high load-bearing capacities in solid and hollow building materials.
- The expansion-free plug neck prevents the creation of expansion forces on the material surface whilst screwing in the screw. This helps to prevent damage to tiles and plaster.
- The pronounced rim prevents the plug from slipping into the drill hole, thus allowing for a simple installation.
- The greater anchorage depth of the SX 6x50, 8x65 and 10x80 means that the plug is especially suited to fixings in hollow building materials, aerated concrete and to bridge plaster.

APPLICATIONS

- Lighting
- Wardrobes
- Motion detectors
- Skirting
- Light shelves
- Mirror cabinets
- Letter boxes
- TV consoles
- Trellis
- Folding shutters
- Bath and toilet installations

PLFUNCTIONING

- The SX is suitable for pre-positioned and push-through installation.
- When turning in the screw, the SX expands in four directions, thus providing a secure anchoring in the building material.
- The required screw length is given by: Plug length + fixture thickness + 1 x screw diameter.
- Suitable for wood, chipboard and spacing screws (fischer ASL, see page 332).

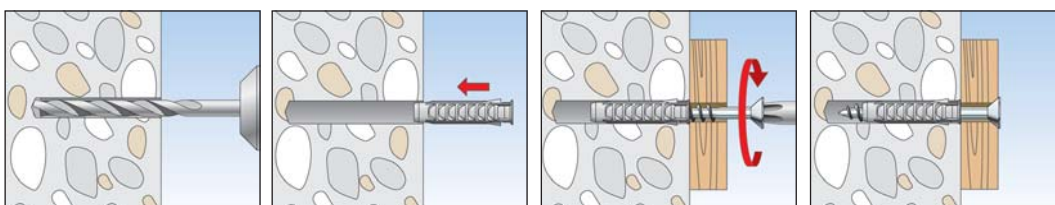

TECHNICAL DATA



Plug **SX** with rim



Plug **SX** - with greater anchorage depth, without rim



Plug **SX** with rim and screw

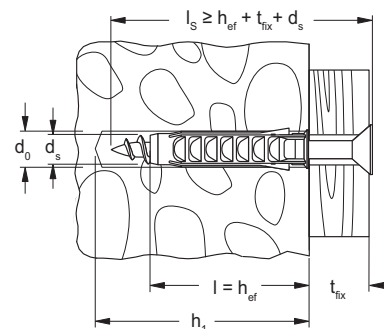

	With rim	With greater anchorage depth, without rim	With rim and screw	Drill hole diameter	Min. drill hole depth	Anchor length	Wood and chipboard screws	Max. fixture thickness	Sales unit
	Art.-No.	Art.-No.	Art.-No.	d_0	h_1	l	$d_s / d_s \times l_s$	t_{fix}	[pcs]
Item	SX	SX	SX-S	[mm]	[mm]	[mm]	[mm]	[mm]	[pcs]
SX 4 x 20	070004	—	—	4	25	20	2 - 3	—	200
SX 5 x 25	070005	—	—	5	35	25	3 - 4	—	100
SX 6 x 30	070006	—	—	6	40	30	4 - 5	—	100
SX 6 x 30	—	—	070021	6	45	30	4,5 x 40	5	50
SX 6 x 50	078185	024827	—	6	60	50	4 - 5	—	100
SX 8 x 40	070008	—	—	8	50	40	4,5 - 6	—	100
SX 8 x 40	—	—	070022	8	65	40	5 x 60	15	50
SX 8 x 65	—	024828	—	8	75	65	4,5 - 6	—	50
SX 10 x 50	070010	—	—	10	70	50	6 - 8	—	50
SX 10 x 80	—	024829	—	10	95	80	6 - 8	—	25
SX 12 x 60	070012	—	—	12	80	60	8 - 10	—	25
SX 14 x 70	070014	—	—	14	90	70	10 - 12	—	20
SX 16 x 80	070016	—	—	16	100	80	12 (1/2")	—	10

TECHNICAL DATA



SX in bucket

Item	Art.-No.	Drill hole diameter	Min. drill hole depth	Anchor length	Max. fixture thickness	Wood and chipboard screws	Sales unit
		d_0	h_1	l	t_{fix}	d_s	[pcs]
		[mm]	[mm]	[mm]	[mm]	[mm]	
SX 6 in bucket	507900	6	40	30	—	4 - 5	3200
SX 8 in bucket	507904	8	50	40	—	4,5 - 6	1200
SX 10 in bucket	507909	10	70	50	—	6 - 8	720
SX 12 in bucket	523269	12	80	60	—	8 - 10	350

TECHNICAL DATA



Box SX 5/6/8

Profi-Box

Box UX / SX-S

Assortment box UX / SX

Item	Art.-No.	Contents	Sales unit [pcs]
Box SX 5/6/8	030191	100 plugs SX 5 x 25, 100 plugs SX 6 x 30, 100 plugs SX 8 x 40	1
Box UX / SX-S	093181	50 plugs UX 6 x 35, 50 screws 4,5 x 50, 50 plugs SX 6 x 30, 50 screws 4,5 x 45, 25 plugs UX 8 x 50, 25 screws 5 x 65, 25 plugs SX 8 x 40, 25 screws 5 x 50	1
Assortment box UX / SX	040991	60 plugs SX 6 x 30, 50 plugs SX 8 x 40, 20 plugs SX 10 x 50, 60 plugs UX 5 x 30 R, 40 plugs UX 6 x 50 R, 50 plugs UX 8 x 50 R, 10 plugs UX 10 x 60 R	1
Profi-Box SX	518524	International version: 60 Expansion plugs SX 6 x 30, 60 Expansion plugs SX 8 x 40, 12 Expansion plugs SX 10 x 50	1
Profi-Box SX + screws	518525	International version: 50 Expansion plugs SX 6 x 30, 30 Expansion plugs SX 8 x 40, 50 Chipboard screws 4,5 x 40, 30 Chipboard screws 5 x 60	1
Meister-Box SX-plug	041648	German version: 60 plugs SX 6 x 30, 60 plugs SX 8 x 40, 12 plugs SX 10 x 50	1
Meister-Box SX + screws	513777	German version: 50 Expansion plugs SX 6 x 30, 30 Expansion plugs SX 8 x 40, 50 Chipboard screws 4,5 x 40, 30 Chipboard screws 5 x 60	1

LOADS

Expansion plug SX

Highest recommended loads¹⁾ for a single anchor.

The given loads are valid for wood screws with the specified diameter.

Type		SX 4 x 20	SX 5 x 25	SX 6 x 30 SX 6 x 50	SX 8 x 40 SX 8 x 65	SX 10 x 50	SX 10 x 80	SX 12 x 60	SX 14 x 70	SX 16 x 80
Wood screw diameter	∅ [mm]	3	4	5	6	8	8	10	12	12
Min. edge distance concrete	c _{min} [mm]	20	25	35	40	50	50	65	100	120
Recommended loads in the respective base material F_{rec}²⁾										
Concrete	≥ C20/25 [kN]	0,16	0,30	0,65	0,70	1,20	1,20	1,70	2,00	2,60
Solid brick	≥ Mz 12 [kN]	0,11	0,25	0,30	0,60	0,65	1,20	0,70	0,80	0,90
Solid sand-lime brick	≥ KS 12 [kN]	0,17	0,30	0,50	0,60	1,20	1,20	1,70	2,00	2,60
Aerated concrete	≥ AAC 2 [kN]	0,03	0,03	0,03	0,04	0,09	0,20	0,14	0,30	0,40
Aerated concrete	≥ AAC 4 [kN]	0,07	0,09	0,09	0,14	0,30	0,60	0,45	0,50	0,60
Vertically perforated brick	≥ Hz 12 (ρ ≥ 1.0 kg/dm ³) [kN]	0,13	0,07	0,07	0,17	0,17	0,50	0,26	0,40	0,60
Perforated sand-lime brick	≥ KSL 12 [kN]	0,15	0,17	0,30	0,35	0,30	0,80	0,35	0,30	0,40
Gypsum block	[kN]	-	-	-	0,26	0,37	-	1,00	1,00	-

¹⁾ Required safety factors are considered.

²⁾ Valid for tensile load, shear load and oblique load under any angle.

The powerful nylon plug with 4-way expansion

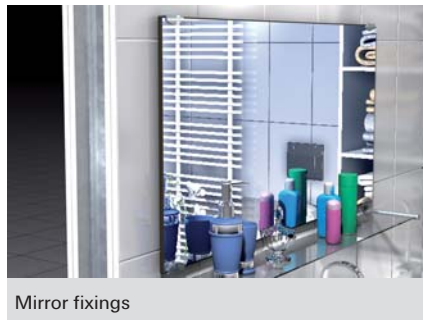

Mirror fixings



Wall consoles

BUILDING MATERIALS

- Concrete
- Vertically perforated brick
- Hollow blocks made from lightweight concrete
- Cavity floor slabs made from bricks and concrete
- Perforated sand-lime brick
- Solid sand-lime brick
- Natural stone with dense structure
- Aerated concrete
- Solid panel made from gypsum
- Solid brick made from lightweight concrete
- Solid brick

CERTIFICATES



ADVANTAGES

- Produced with at least 50% renewable raw materials and therefore particularly environmentally friendly.
- Just as effective, secure and durable as regular SX plugs.
- The powerful 4-way expansion provides optimum force transmission in the building material, thus enabling high load values and security.
- The anti-rotation lock prevents the plug from spinning in the drill hole.
- The expansion-free plug neck prevents the creation of expansion forces on the material whilst screwing in the screw. This helps to prevent damage to tiles and plaster.
- Fast and easy push-through installation reduces installation time.

APPLICATIONS

- Lighting
- Wardrobes
- Motion detectors
- Skirting
- Light shelves
- Mirror cabinets
- Letter boxes
- TV consoles
- Trellis
- Folding shutters
- Bath and toilet installations

FUNCTIONING

- The SX GREEN is suitable for pre-positioned and push-through installation.
- When screwing in the screw, the SX GREEN expands in four directions, thus providing a secure anchoring in the building material.
- The required screw length is given by the plug length + fixture thickness + 1 x screw diameter.
- Suitable for wood, chipboard and spacing screws.

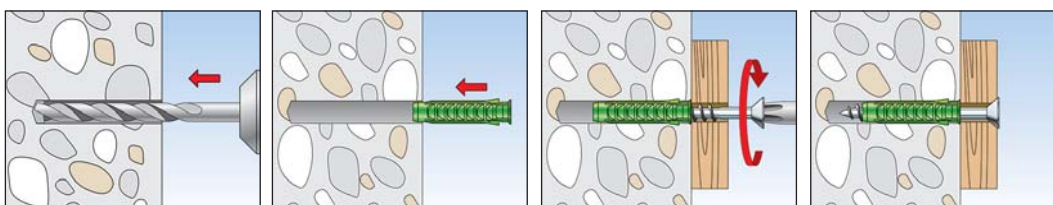

TECHNICAL DATA



Plug **SX GREEN** - with rim



Plug **SX GREEN** - with greater anchorage depth, without rim



Plug **SX GREEN S** - with rim and screw

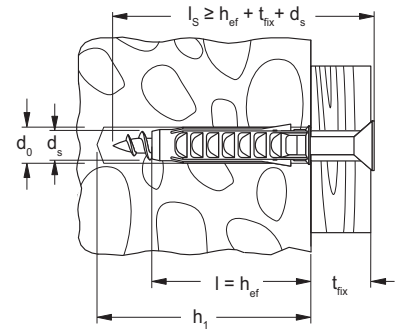

6 General fixings

	With rim	Without rim and large anchorage depth	With rim and screw	Drill hole diameter d_0	Min. drill hole depth h_1	Anchor length l	Max. fixture thickness t_{fix}	Wood and chip-board screws $d_s / d_s \times l_s$	Sales unit [pcs]
	Art.-No.	Art.-No.	Art.-No.	[mm]	[mm]	[mm]	[mm]	[mm]	
Item	SX	SX	SX-S						
SX GREEN 5 x 25	524859	—	—	5	35	25	—	3 - 4	90
SX GREEN 6 x 30	524860	—	—	6	40	30	—	4 - 5	90
SX GREEN 6 x 30	—	—	524866	6	40	30	5	4,5 x 40	45
SX GREEN 6 x 50	—	524861	—	6	60	50	—	4 - 5	90
SX GREEN 8 x 40	524862	—	—	8	50	40	—	4,5 - 6	90
SX GREEN 8 x 40	—	—	524867	8	60	40	15	5 x 60	45
SX GREEN 8 x 65	—	524863	—	8	75	65	—	4,5 - 6	45
SX GREEN 10 x 50	524864	—	—	10	70	50	—	6 - 8	45
SX GREEN 12 x 60	524865	—	—	12	80	60	—	8 - 10	20

LOADS

Expansion plug SX GREEN

Highest recommended loads¹⁾ for a single anchor.

The given loads are valid for wood screws with the specified diameter.

Type		SX GREEN 5 x 25	SX GREEN 6 x 30 SX GREEN 6 x 50	SX GREEN 8 x 40 SX GREEN 8 x 65	SX GREEN 10 x 50	SX GREEN 12 x 60
Wood screw diameter	\emptyset [mm]	4	5	6	8	10
Min. edge distance concrete	c_{min} [mm]	25	35	40	50	65
Recommended loads in the respective base material F_{rec}²⁾						
Concrete	$\geq C20/25$ [kN]	0,30	0,65	0,70	1,20	1,70
Solid brick	$\geq Mz 12$ [kN]	0,25	0,30	0,60	0,65	0,70
Solid sand-lime brick	$\geq KS 12$ [kN]	0,30	0,50	0,60	1,20	1,70
Aerated concrete	$\geq AAC 2$ [kN]	0,03	0,03	0,04	0,09	0,14
Aerated concrete	$\geq AAC 4$ [kN]	0,09	0,09	0,14	0,30	0,45
Vertically perforated brick	$\geq Hlz 12$ ($\rho \geq 1.0 \text{ kg/dm}^3$) [kN]	0,07	0,07	0,17	0,17	0,26
Perforated sand-lime brick	$\geq KSL 12$ [kN]	0,17	0,30	0,35	0,30	0,35
Gypsum block	[kN]	-	-	0,26	0,37	1,00

¹⁾ Required safety factors are considered.

²⁾ Valid for tensile load, shear load and oblique load under any angle.

The installation-friendly nylon plug with 2-way expansion



Small shelves

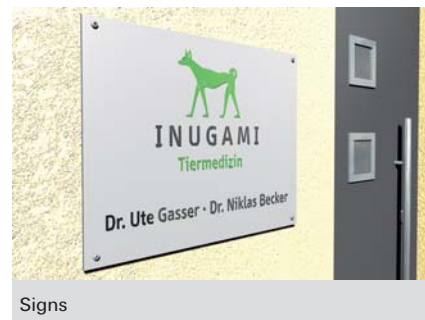

Signs

BUILDING MATERIALS

- Concrete
- Solid sand-lime brick
- Natural stone with dense structure
- Solid brick made from lightweight concrete
- Solid brick

CERTIFICATES



ADVANTAGES

- The rimless plug sleeve allows for the plug to be set as deep as required below the plaster to the bearing substrate to achieve the maximum load-bearing capacity.
- As the plug only expands in two directions, it is possible to direct the expansion forces so that they run parallel to the edge of the building material by turning the plug. This allows for smaller edge distances.
- The slimline plug geometry makes it easy to push the plug into the drill hole. For a fast and simple installation.
- The anti-rotation lock prevents the plug rotating in the drill hole, thus guaranteeing a high level of installation safety.

APPLICATIONS

- Pictures
- Lighting
- Skirting
- Light shelves
- Mirror cabinets
- Letter boxes
- Motion detectors
- Information boards
- Curtain rails
- Electrical installations

FUNCTIONING

- The expansion plug S is suitable for pre-positioned and push-through installation.
- When turning in the screw, the expansion plug S expands in two directions, thus providing a secure anchoring in the building material.
- The required screw length is given by the plug length + plaster and/or insulation material thickness + fixture thickness + 1 x screw diameter.
- Suitable for wood and chipboard screws.
- The edge distance must be at least one plug length.
- For installations close to the edge, turn the plug so that the expansion force acts parallel to the edge.

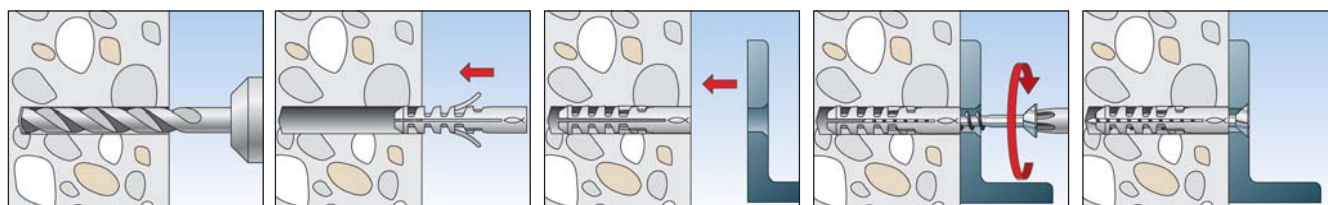

TECHNICAL DATA



Expansion plug S

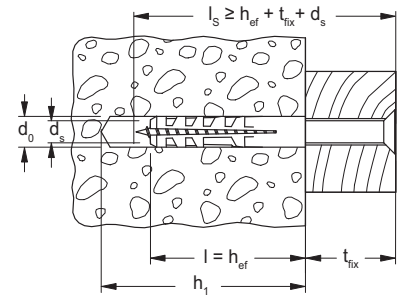

General fixings 6

Item	Art.-No.	Art.-No.	Drill hole diameter d_0 [mm]	Anchor length l [mm]	Min. drill hole depth h_1 [mm]	Wood and chipboard screws d_s [mm]	Sales unit [pcs]		
	Standard	Doublepack							
S 4	050104	—	4	20	25	2 - 3	200		
S 5	050105	—	5	25	35	3 - 4	100		
S 5	—	050124	5	25	35	3 - 4	200		
S 6	050106	—	6	30	40	4 - 5	100		
S 6	—	050125	6	30	40	4 - 5	200		
S 8	050108	—	8	40	55	4,5 - 6	100		
S 8	—	050126	8	40	55	4,5 - 6	200		
S 10	050110	—	10	50	70	6 - 8	50		
S 10	—	050127	10	50	70	6 - 8	100		
S 12	050112	—	12	60	80	8 - 10	25		
S 14	050114	—	14	75	90	10 - 12	20		
S 16	050116	—	16	80	100	12 (1/2")	10		
S 20	050120	—	20	90	120	16	5		

TECHNICAL DATA



S in bucket

Item	Art.-No.	Drill hole diameter d_0 [mm]	Min. drill hole depth h_1 [mm]	Anchor length l [mm]	Wood and chipboard screws d_s [mm]	Sales unit [pcs]	
S 6 in bucket	508024	6	40	30	4 - 5	3200	
S 8 in bucket	508025	8	55	40	4,5 - 6	1400	

TECHNICAL DATA



Stacking box ST



fischerbox

Item	Art.-No.	Contents	Sales unit [pcs]
ST 1 S8 S	060510	34 plugs S 8, 34 countersunk wood screws SH 5 x 60	1
ST 1 S6 S	060509	50 plugs S 6, 50 countersunk wood screws SH 4,5 x 45	1
ST 1 S6/8	060499	50 plugs S 6, 30 plugs S 8	1
Box S 5.6.8	060513	100 plugs S 5, 100 plugs S 6, 100 plugs S 8	1
Box S 6.8.10	060515	100 plugs S 6, 100 plugs S 8, 25 plugs S 10	1
Box empty	060500	–	1

LOADS

Expansion plug S

Highest recommended loads¹⁾ for a single anchor.

The given loads are valid for wood screws with the specified diameter.

Type		S4	S5	S6	S8	S10	S12	S14	S16	S20
Wood screw diameter	∅ [mm]	3	4	5	6	8	10	12	12	16
Min. edge distance concrete	c _{min} [mm]	20	25	30	40	50	60	70	80	100
Recommended loads in the respective base material F_{rec} ²⁾										
Concrete	≥ C20/25 [kN]	0,16	0,28	0,40	0,60	1,10	1,50	1,85	2,26	3,88
Solid brick	≥ Mz 12 [kN]	0,14	0,24	0,28	0,50	- ³⁾	- ³⁾	- ³⁾	- ³⁾	- ³⁾
Solid sand-lime brick	≥ KS 12 [kN]	0,14	0,24	0,28	0,55	- ³⁾	- ³⁾	- ³⁾	- ³⁾	- ³⁾
Aerated concrete	≥ AAC 4 [kN]	- ³⁾	- ³⁾	0,05	0,07	0,16	0,28	0,40	- ³⁾	- ³⁾
Gypsum block	[kN]	- ³⁾	- ³⁾	- ³⁾	0,15	0,23	0,37	0,60	- ³⁾	- ³⁾

¹⁾ Required safety factors are considered.

²⁾ Valid for tensile load, shear load and oblique load under any angle.

³⁾ Due to that the failure of the substrate varies too much no reproducible values can be given.

The economical hammer-set plug - easy and quick fixing of threaded rods



Suspended ceilings



Single pipe suspension

BUILDING MATERIALS

- Concrete
- Solid sand-lime brick
- Solid brick

ADVANTAGES

- The innovative plug geometry allows quick and easy installation of the threaded rod with a few hammer blows.
- The short plug length prevents reinforcement hits and guarantees a secure utilization in reinforced concrete.
- The teeth inside the plug allow standard, metric threads to be held: This saves a large assortment of stud screws.
- Installation without special tools: The only thing needed to set the plug is a hammer. Visible edge of the plug serves as visual setting check and guarantees correct setting.
- The visible edge of the plug serves as visual setting check and guarantees correct setting.
- Easy to check and adjust: To check the setting depth, the closed plug tip is used as a stop point. This predetermined break point also allows the threaded rod to be hammered-in deeper.

APPLICATIONS

- Suspension for individual pipes
- Plumbing and heating fixings
- Cable and pipe clips
- Suspended ceilings
- Ceiling lights
- Consoles
- Mounting rails

FUNCTIONING

- When hammering-in the threaded rod, the plug expands in four directions as a result of the conical inner geometry.
- The plug is set using pre-positioned installation and this is possible in two different ways: Pre-installation of the threaded rods in the plug with both being hammered into the wall together or pre-inserting of the RODFORCE into the drill hole followed by hammering-in of the threaded rod.
- The teeth inside the plug mechanically interlock the metric thread securely with the threaded rod.
- The unique elements on the outside of the plug brace against the wall of the drill hole.

INSTALLATION WITHIN THE SYSTEM

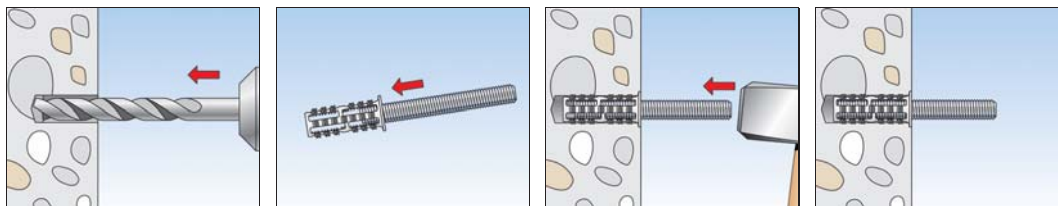

INSTALLATION WITH INDIVIDUAL COMPONENTS

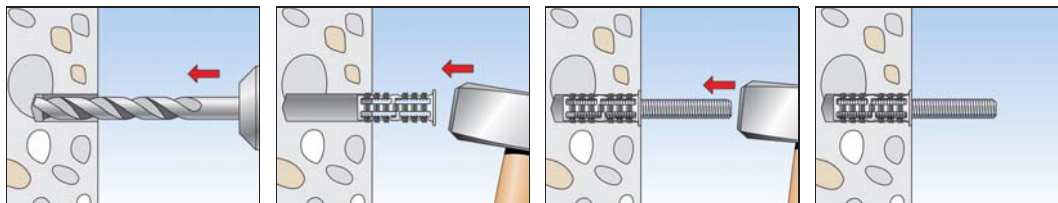

TECHNICAL DATA



Threaded rod plug **RODFORCE FGD**

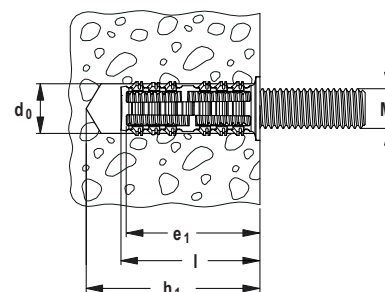

Item	Art.-No.	Drill diameter	Min. drill hole depth	Anchor length	Min. drop-in penetration	Threaded rod	Sales unit
		d_0 [mm]	h_1 [mm]	l [mm]	e_1 [mm]	$\emptyset \times$ length [mm]	[pcs]
RODFORCE FGD 10 M6	542106	10	40	35	33	—	50
RODFORCE FGD 10 M6 TR 50	542107	10	40	35	33	M 6 x 50	25
RODFORCE FGD 10 M6 TR 60	542108	10	40	35	33	M 6 x 60	25
RODFORCE FGD 10 M6 TR 80	542109	10	40	35	33	M 6 x 80	25
RODFORCE FGD 12 M8	542111	12	40	35	33	—	50
RODFORCE FGD 12 M8 TR 50	542112	12	40	35	33	M 8 x 50	25
RODFORCE FGD 12 M8 TR 60	542113	12	40	35	33	M 8 x 60	25
RODFORCE FGD 12 M8 TR 80	542114	12	40	35	33	M 8 x 80	25

LOADS

Threaded rod plug RODFORCE FGD

Highest recommended loads¹⁾ for a single anchor.

The given loads are valid for machine screws or threaded rods with the specified thread size.

Type		RODFORCE FGD M6	RODFORCE FGD M8
Thread size	\emptyset [mm]	M6	M8
Recommended loads in the respective base material F_{rec}²⁾			
Concrete	\geq C20/25 [kN]	0,31	0,36
Solid brick	\geq Mz 12 [kN]	0,19	0,33
Solid sand-lime brick	\geq KS 12 [kN]	0,31	0,36

¹⁾ Required safety factors are considered.

²⁾ Valid for tensile load, shear load and oblique load under any angle.

The metal anchor for wood and chipboard screws



Pipes



Gas meters

BUILDING MATERIALS

- Concrete
- Vertically perforated brick
- Hollow blocks made from lightweight concrete
- Cavity floor slabs made from bricks and concrete
- Perforated sand-lime brick
- Solid sand-lime brick
- Natural stone with dense structure
- Aerated concrete
- Solid brick made from lightweight concrete
- Solid panel made from gypsum

ADVANTAGES

- The metal expansion anchor FMD is especially suited to applications in installation technology.
- The external teeth expand in the building material, thus ensuring a high load-bearing capacity.
- The ribbed internal geometry of the FMD is suitable for wood and chipboard screws, and makes it possible to guide the screw securely. This offers increased installation safety, and enables a broad range of applications.

APPLICATIONS

- Gas pipes
- Water pipes
- Cable and pipe clips

FUNCTIONING

- The FMD is suitable for pre-positioned installation.
- Inserting the screw causes the FMD to expand, and the metal teeth fix the anchor securely in the building material.
- The required (stud) screw length is given by: Anchor length + plaster and/or insulation layer thickness + fixture thickness or installation spacing + 1 x screw diameter.
- Suitable for wood and chipboard screws.
- The drill diameter is relative to the compressive strength of the building material. The higher the compressive strength, the greater the drill diameter. The 6x32 and 8x38 sizes can be hammered directly into low-strength aerated concrete without the need for pre-drilling.

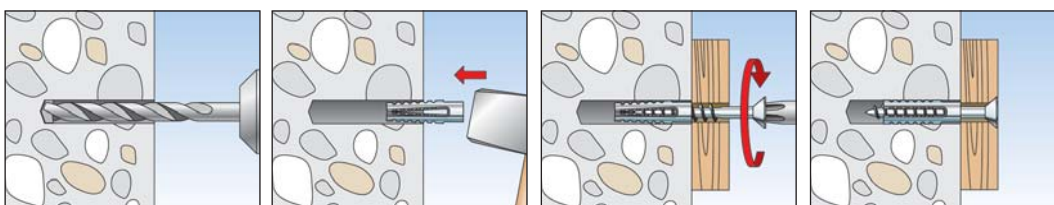

TECHNICAL DATA



Metal expansion fixing FMD

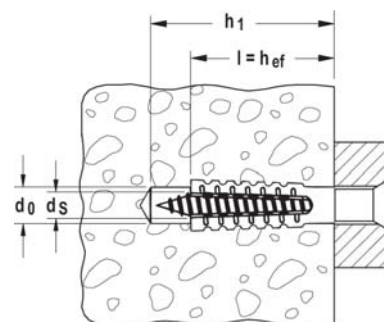

Item	Art.-No.	Drill hole diameter	Min. drill hole depth	Anchor length	Screw diameter	Sales unit		
		d_0 [mm]	h_1 [mm]	l [mm]	d_s [mm]	[pcs]		
FMD 6 x 32	061224 ¹⁾	6 - 7	38	32	5 - 6	100		
FMD 8 x 38	061225 ¹⁾	10 - 12	46	38	6 - 8	100		
FMD 8 x 60	061226 ¹⁾	10 - 12	68	60	6 - 8	50		
FMD 10 x 60	061209 ¹⁾	12 - 14	68	60	8 - 10	50		

¹⁾ The drill diameter is relative to the substrate compressive strength. Generally, the higher the compressive strength, the greater the drill diameter.

Details see table "Recommended drill hole diameter".

RECOMMENDED DRILL HOLE DIAMETER [mm]

Type		FMD 6 x 32	FMD 8 x 38	FMD 8 x 60	FMD 10 x 60
Concrete	C 20/25	7	10	12	14
Aerated concrete	PB4	6	10	10	12
Vertically perforated brick	HLZ 12	7	10	10	12

LOADS

Metal expansion fixing FMD

Highest recommended loads¹⁾ for a single anchor.

The given loads are valid for wood screws with maximum diameter.

Type			FMD 8 x 38	FMD 8 x 60	FMD 10 x 60
Wood screw diameter	\emptyset	[mm]	8	8	10
Recommended loads in the respective base material F_{rec} ²⁾					
Aerated concrete	\geq PB 2, PP 2 (G 2)	[kN]	0,20	0,30	0,40
Aerated concrete	\geq AAC 4	[kN]	0,30	0,40	0,60

¹⁾ Required safety factors are considered.

²⁾ Valid for tensile load, shear load and oblique load under any angle.

The expansion plug for metric screws and threaded bolts

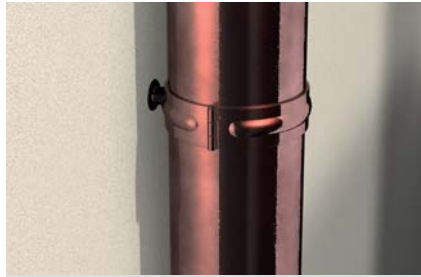

Downpipes



Folding shutters

6
General fixings

BUILDING MATERIALS

- Concrete
- Cavity floor slabs made from bricks and concrete
- Perforated sand-lime brick
- Solid sand-lime brick
- Natural stone with dense structure
- Solid brick made from lightweight concrete
- Solid brick
- Solid panel made from gypsum
- Vertically perforated brick
- Aerated concrete

CERTIFICATES



ADVANTAGES

- The internal geometry of the M-S allows for the use of standard metric screws or threaded rods for the ideal adaptation to suit the intended use.
- The rimless plug sleeve allows for the plug to be set as deep as required below the plaster to the bearing substrate to achieve the maximum load-bearing capacity.
- As the plug only expands in two directions, it is possible to direct the expansion forces so that they run parallel to the edge of the building material by turning the plug. This allows for smaller edge distances.
- The slimline plug geometry makes it easy to push the plug into the drill hole, for a fast and simple installation.

APPLICATIONS

- Handles
- Folding shutters
- Trellis
- Downpipes
- Stand-off installation
- Window fittings
- Gratings

FUNCTIONING

- The M-S is suitable for pre-positioned and push-through installation.
- When turning in the screw, the M-S expands in two directions, thus providing a secure anchoring in the building material.
- The required screw length is given by: Plug length + plaster and/or insulation layer thickness + fixture thickness + 1 x screw diameter.
- Suitable for metric screws and threaded bolts.
- Chamfer the thread to make it easier to screw in screws and threaded rods.

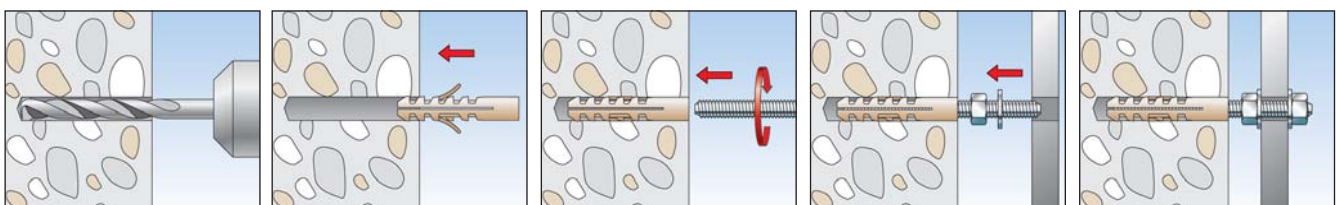

TECHNICAL DATA



Anchor **M-S** for metric screws

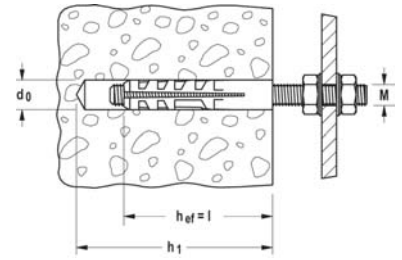

Item	Art.-No.	Drill hole diameter	Min. drill hole depth	Anchor length	Thread	Sales unit		
		d_0 [mm]	h_1 [mm]	l [mm]	M	[pcs]		
M 6 S	050152	8	55	40	M 6	100		
M 8 S	050153	10	70	50	M 8	50		
M 10 S	050154	14	90	70	M 10	20		
M 12 S	050155	16	100	80	M 12	10		

LOADS

Anchor M-S

Highest recommended loads¹⁾ for a single anchor.
The given loads are valid for metric screws with the specified thread size.

Type		M6 S	M8 S	M10 S	M12 S
Thread size	[M]	M6	M8	M10	M12
Recommended loads in the respective base material F_{rec}²⁾					
Concrete	C20/25 [kN]	0,30	0,54	0,66	1,06
Solid brick	Mz 12 [kN]	0,24	0,33	0,46	0,79
Solid sand-lime brick	KS 12 [kN]	0,24	0,33	0,43	0,71

¹⁾ Required safety factors are considered.

²⁾ Valid for tensile load, shear load and oblique load under any angle.

The powerful nylon expansion anchor with brass cone for metric threads



Plant construction



Protective grilles

General fixings 6

BUILDING MATERIALS

- Concrete
- Natural stone with dense structure
- Solid brick
- Solid sand-lime brick
- Solid brick made from lightweight concrete
- Aerated concrete
- Solid panel made from gypsum
- Hollow blocks made from lightweight concrete

CERTIFICATES



ADVANTAGES

- The anchor's large external diameter helps to achieve a large applied load in the building material. This allows for maximum load-bearing capacity.
- The anchor's high expansion makes it insensitive to building material tolerances. This guarantees a simple and secure installation.
- The internal thread allows for the use of standard metric screws or threaded rods, and for surface flush removal and reuse of the fixing point. This provides great flexibility.

APPLICATIONS

- Machines
- Curbs
- Control boxes

FUNCTIONING

- The M anchor is suitable for pre-positioned installation.
- Turning in the screw causes the internal brass cone to expand the M anchor, thus reliably anchoring it in the building material.
- The required screw length is given by anchor length + fixture thickness.
- Suitable for metric screws and threaded bolts.

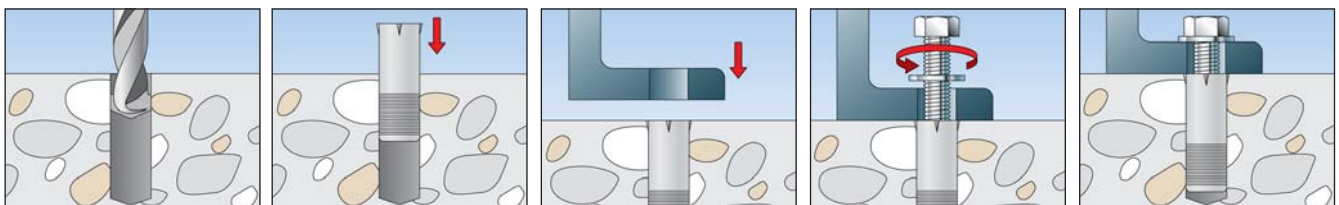

TECHNICAL DATA



Anchor **M** for metric screws

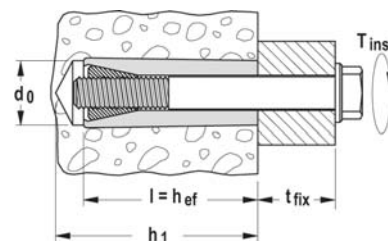

Item	Art.-No.	Drill hole diameter d_0 [mm]	Min. drill hole depth h_1 [mm]	Anchor length l [mm]	Thread M	Max. installation torque T_{inst} [Nm]	Sales unit [pcs]
M 5	050505 ¹⁾	10	45	35	M 5	4	50
M 6	050506 ¹⁾	12	50	40	M 6	7	50
M 8	050508 ¹⁾	16	65	50	M 8	16	20
M 10	050510 ¹⁾	20	80	60	M 10	32	10
M 12	050512 ¹⁾	24	90	65	M 12	54	5

¹⁾ The given torque values apply to screws of strength class ≥ 5.8 .

LOADS

Anchor M

Highest recommended loads¹⁾ for a single anchor.

The given loads are valid for metric screws with the specified thread size.

Type		M 5	M 6	M 8	M 10	M 12
Thread size	[M]	M5	M6	M8	M10	M12
Recommended loads in the respective base material F_{rec} ²⁾						
Concrete	$\geq C20/25$ [kN]	1,10	1,80	2,60	4,40	5,00

¹⁾ Required safety factors are considered.

²⁾ Valid for tensile load, shear load and oblique load under any angle.

The brass expansion fixing with metric thread



Protective wall panels



Small shelves

BUILDING MATERIALS

- Concrete
- Solid sand-lime brick
- Natural stone with dense structure
- Solid brick

ADVANTAGES

- The compact design of the brass fixing reduces the amount of drilling required, helping to ensure a fast installation.
- The special surface structure of the MS prevents the fixing from rotating in the drill hole. This provides increased installation safety.
- The internal thread allows for the use of standard metric screws or threaded rods, and for surface flush removal and reuse of the fixing point. This provides great flexibility.

APPLICATIONS

- Cellar shelves
- Substructures made of wood and metal
- Boilers
- Aggregates
- Control boxes
- Curtain rails

FUNCTIONING

- The MS brass fixing is suitable for pre-positioned installation.
- Turning in the metric screw causes the front part of the brass fixing to expand, thus securely anchoring it in the substrate.
- Calculating screw length for flush fixing installation: Fixing length + fixture thickness = min. screw length.
- Suitable for metric screws and threaded bolts.

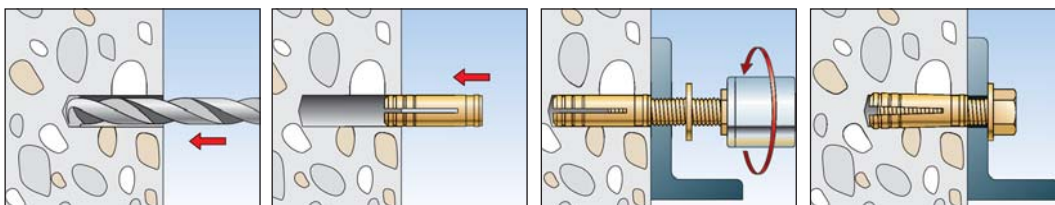

TECHNICAL DATA



Brass fixing **MS** for metric screws

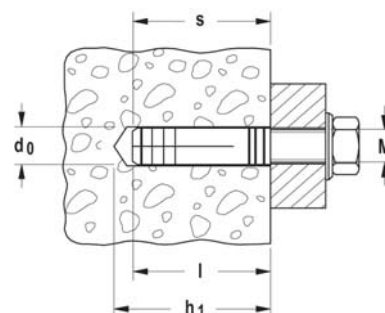

Item	Art.-No.	Drill hole diameter d_0 [mm]	Min. drill hole depth h_1 [mm]	Anchor length l [mm]	Internal thread A1	Min. bolt penetration $l_{E,min}$ [mm]	Sales unit [pcs]
MS 4 x 15	026424	5	20	15	M 4	15	100
MS 5 x 18	026425	6	25	18	M 5	18	100
MS 6 x 22	078660	8	27	22	M 6	22	100
MS 8 x 28	078981	10	35	28	M 8	28	50
MS 10 x 32	078661	12	39	32	M 10	32	25
MS 12 x 37	078662	15	46	37	M 12	37	10
MS 16 x 43	078663	20	50	43	M 16	43	10

LOADS

Brass fixing MS

Highest recommended loads¹⁾ for a single anchor.

The given loads are valid for metric screws with the specified thread size.

Type		MS 4 x 15	MS 5 x 18	MS 6 x 22	MS 8 x 28	MS 10 x 32	MS 12 x 37	MS 16 x 43	
Thread size	[M]	M4	M5	M6	M8	M10	M12	M16	
Recommended loads in the respective base material F_{rec}²⁾									
Concrete	$\geq C20/25$	[kN]	0,25	0,40	0,65	1,10	1,60	2,20	3,30
Solid brick		[kN]	0,20	0,35	0,55	0,90	1,30	1,60	2,30

¹⁾ Required safety factors are considered.

²⁾ Valid for tensile load, shear load and oblique load under any angle.

The special plug for different fixings in aerated concrete

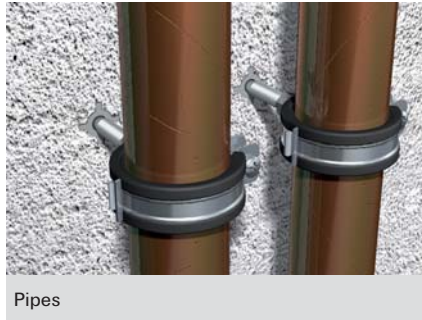

6
General fixings

BUILDING MATERIALS

Approved for (GB 10) resp. suitable for (GB 8 and GB 14):

- Aerated concrete \geq AAC 2

Also suitable for:

Aerated concrete and ceiling panels of compressive strength \geq 3.3

CERTIFICATES



ADVANTAGES

- The general building approval guarantees approved safety for use in safety-relevant applications.
- The spiral-shaped outer ribs cut a positive fit in the soft building material, thus ensuring the best pressure distribution and load-bearing capacity.
- Can be applied with a hammer - there is no need for special tools, thus saving time and money for the installation.
- The GB can also be used safely outside (e.g. in façade installation) when combined with the approved fischer safety screw in A4.

APPLICATIONS

- Light cable trays
- Pipelines
- Guard rails
- Façade and roof constructions made of wood and metal
- Light canopy brackets
- Letter boxes
- Trellis

FUNCTIONING

- The GB is suitable for pre-positioned installation.
- The spiral-shaped outer ribs ensure a positive fit connection between the building material and anchor.
- The required screw length is given by: Anchor length + fixture thickness + 1 x screw diameter.
- The GB 10 must be used with fischer safety screws to fulfil the approval and to achieve the maximum load-bearing capacity.
- Use rotary drilling to create the drill hole
- Can be used in unplastered aerated concrete

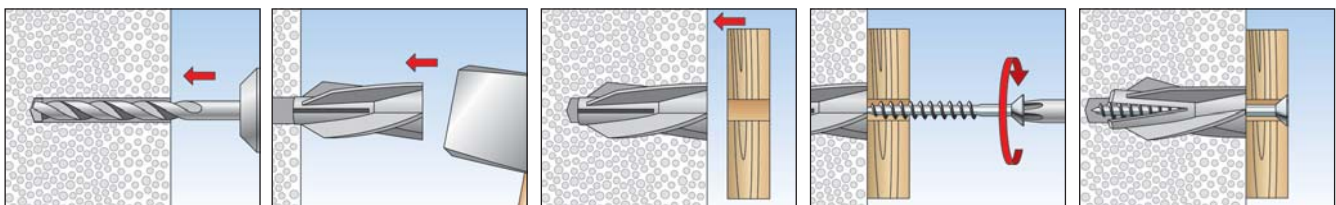

TECHNICAL DATA





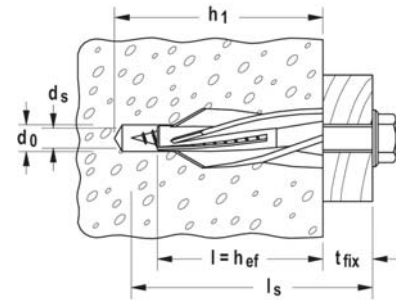

Aircrete anchor GB



Item	Art.-No.	Approval DIBt	Drill hole diameter d_0 [mm]	Min. drill hole depth h_1 [mm]	Plug length = min. anchorage depth $l = h_{ef}$ [mm]	fischer safety screw $d_s \times l_s$ [mm]	Sales unit [pcs]		
GB 8	050491	—	8	60	50	5	25		
GB 10	050492	●	10	65	55	7	20		
GB 14	050493	—	14	90	75	10	10		

FISCHER SAFETY SCREW FOR GB

Fixing type	Usable length t_{fix}		Screw dimension * $\emptyset \times l_s$	Screw material			
	[mm] min.	[mm] max.		Zinc plated and passivated steel		Stainless steel of the corrosion resistance classe III, e.g. A4	
				 Art.-No.	 Art.-No.	 Art.-No.	 Art.-No.
GB 8	5	30	5 x 85	089230 ¹⁾		089240 ¹⁾	
GB 10	0	5	7 x 67		080404		
	5	25	7 x 87	089170	080405	089244	080261
	25	45	7 x 107	089172			
	40	58	7 x 120	089174	080407		
	60	78	7 x 140	089176	080408		
GB 14	85	105	7 x 167	089178			
	0	10	10 x 95		080412		
	0	20	10 x 105	089186	080413		080271
	35	55	10 x 140	089188	080415		
	60	80	10 x 165		080416		

¹⁾ Cross drive recess Z

* Further sizes on request

LOADS

Aircrete anchor GB

Highest permissible, respectively recommended loads¹⁾²⁾ for a single anchor in aerated concrete.

The given loads are valid for fischer safety screws⁴⁾ acc. to selection table.

Type	GB 10 ²⁾		GB 8 ⁹⁾	GB 14 ⁹⁾	
Diameter fischer safety screw	\emptyset	[mm]	7	5	10
Min. spacings ⁶⁾	s_{min}	[mm]	100	150 (100) ⁸⁾	300 (200) ⁸⁾
Min. edge distance ⁷⁾	c_{min}	[mm]	100	100 (75) ⁸⁾	200 (150) ⁸⁾
Minimum member thickness	h_{min}	[mm]	120	75	200
Anchorage depth	h_{ef} (h_v)	[mm]	55	50	75
Load in the respective base material			Recommended loads F_{rec}³⁾		
Aerated concrete	AAC 2	[kN]	0,21	0,20	0,40
Aerated concrete	AAC 3	[kN]	0,32 (0,43) ⁵⁾	0,30	0,80
Aerated concrete	AAC 4	[kN]	0,54 (0,71) ⁵⁾	0,40	0,90

¹⁾ Required safety factors are considered.

²⁾ In case of the design of the GB 10 for tension, shear and bending the complete approval Z-21.2-123 has to be considered.

³⁾ Valid for tensile load, shear load and oblique load under any angle.

⁴⁾ Galvanised steel (gvz) and stainless steel A4.

⁵⁾ The values in brackets are decisive for member thickness ≥ 150 mm.

⁶⁾ Minimum possible axial spacing while reducing the permissible load.

⁷⁾ Minimum possible edge distance.

⁸⁾ Values in brackets apply to AAC 2.

⁹⁾ GB 8 and GB 14 are not part of the approval.

Secure in aerated concrete



BUILDING MATERIALS

- Aerated concrete \geq AAC 2
- Aerated concrete and ceiling panels of compressive strength \geq 3.3

CERTIFICATES



ADVANTAGES

- Produced with at least 50% renewable raw materials and therefore particularly environmentally friendly.
- The spiral-shaped outer ribs cut a positive fit in the soft building material, thus ensuring best pressure distribution and load-bearing capacity.
- Can be applied with a hammer – there is no need for special tools, thus saving time and money for the installation.

APPLICATIONS

- Pipelines
- Letter boxes
- Trellis
- Handles
- Gratings
- Electrical installations

FUNCTIONING

- The aircrete anchor GB GREEN is suitable for pre-positioned installation.
- The spiral-shaped outer ribs cut a positive fit into the soft building material when knocked in, thus ensuring optimal pressure distribution and load-bearing capacity.
- The required screw length is given by the plug length + fixture thickness + 1 x screw diameter.
- Rotary drilling of the hole is required.
- Can be used in unplastered aerated concrete.

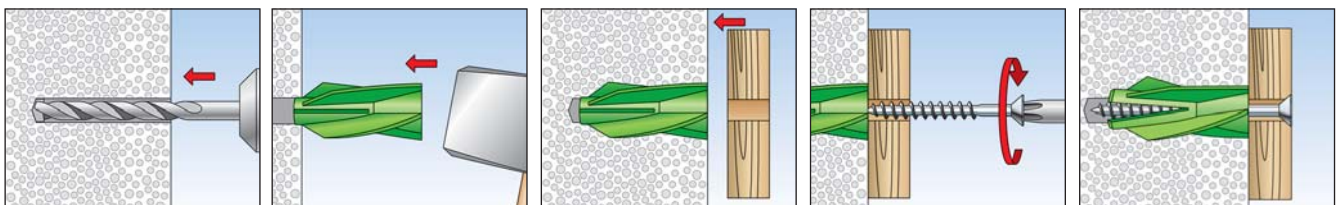

6
General fixings

TECHNICAL DATA



Aircrete anchor **GB GREEN**

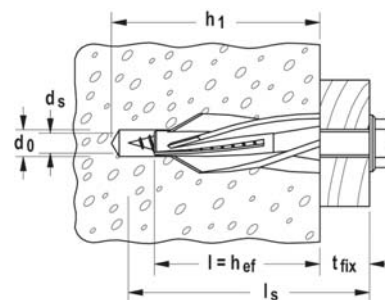

Item	Art.-No.	Drill hole diameter d_0 [mm]	Min. drill hole depth h_1 [mm]	Plug length = min. anchorage depth $l = h_{ef}$ [mm]	fischer safety screw $d_s \times l_s$ [mm]	Sales unit [pcs]
GB GREEN 8	524870	8	60	50	5	20
GB GREEN 10	524871	10	65	55	7	18

LOADS

Aircrete anchor GB GREEN

Highest recommended loads¹⁾ for a single anchor in aerated concrete.

The given loads are valid for fischer safety screws⁴⁾ acc. attached table.

Type			GB GREEN 8	GB GREEN 10
Diameter fischer safety screw	\emptyset	[mm]	5	7
Min. spacing ⁶⁾	s_{min}	[mm]	150 (100) ⁷⁾	100
Min. edge distance ²⁾	c_{min}	[mm]	100 (75) ⁷⁾	100
Minimum member thickness	h_{min}	[mm]	75	120
Anchorage depth	$h_{ef} (h_v)$	[mm]	50	55
Recommended load in the respective base material F_{rec}³⁾				
Aerated concrete	AAC 2	[kN]	0,20	0,21
Aerated concrete	AAC 3	[kN]	0,30	0,32 (0,43) ⁵⁾
Aerated concrete	AAC 4	[kN]	0,40	0,54 (0,71) ⁵⁾

¹⁾ Required safety factors are considered.

²⁾ Minimum possible edge distance.

³⁾ Valid for tensile load, shear load and oblique load under any angle.

⁴⁾ Galvanised steel (gvz) and stainless steel A4.

⁵⁾ The values in brackets are decisive for member thickness ≥ 150 mm.

⁶⁾ Minimum possible axial spacing while reducing the recommended load.

⁷⁾ Values in brackets apply to AAC 2.

The versatile nylon anchor for aerated concrete



External lighting



Radiators

BUILDING MATERIALS

- Aerated concrete
- Solid panel made from gypsum

CERTIFICATES



ADVANTAGES

- The FTP K is suitable for both wood screws and metric screws, and thus offers flexibility in screw choice.
- The spiral-shaped outer thread taps itself into the soft aerated concrete with a positive fit, thus ensuring a secure hold.
- Setting with the FTP EK setting tool requires only a small amount of force. For a convenient installation.
- The special geometry allows for an almost expansion-force-free anchoring. This allows for small edge and spacing distances, and avoids splitting in the case of plastered surfaces.

APPLICATIONS

- Pictures
- Lighting
- Shelves
- Mirror cabinets
- Letter boxes
- Signs
- Motion detectors
- Cable and pipe clips
- Stand-off installations

FUNCTIONING

- The FTP K is suitable for pre-positioned installation.
- Set the FTP K with setting tool FTP EK. The aircrete anchor taps itself into the aerated concrete with a positive fit during the installation process.
- Suitable for wood and metric screws with diameter 4 to 10 mm.

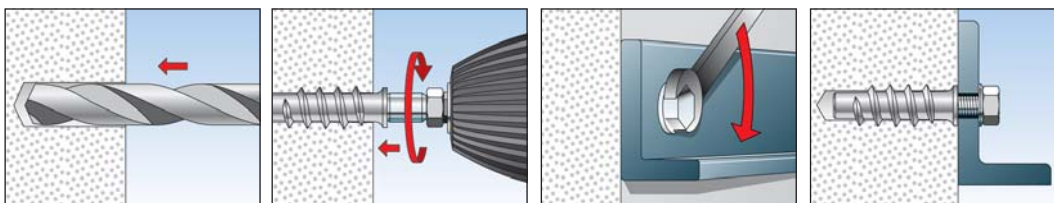

TECHNICAL DATA



Turbo aircrete anchor **FTP K** (nylon)

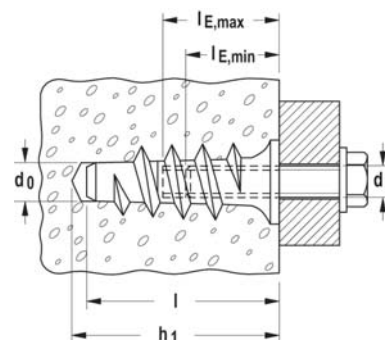

Item	Art.-No.	Drill hole diameter d_0 [mm]	Min. drill hole depth h_1 [mm]	Anchor length l [mm]	Woodscrew diameter d_s [mm]	Metric screw M	Min. bolt penetration $l_{E,min}$ [mm]	Max. bolt penetration $l_{E,max}$ [mm]	Sales unit [pcs]
FTP K 4	078411 ¹⁾	8 - (10)	60	50	4 - 4,5	M 4	35	60	25
FTP K 6	078412 ¹⁾	8 - (10)	60	50	5 - 6	M 5 - 6	40	60	25
FTP K 8	078413 ¹⁾	10 - (12)	70	60	7 - 8	M 8	45	70	25
FTP K 10	078414 ¹⁾	12 - (14)	80	70	9 - 10	M 8 - 10	50	80	10

¹⁾ Values in brackets for drill hole diameter apply for aerated concrete, compressive strength of 5,0 N/mm² or higher.

ACCESSORIES



FTP EK 4/6



FTP EK 8



FTP EK 10

Item	Match	Sales unit [pcs]
FTP EK 4/6	090990 FTP K4 / FTP K6	1
FTP EK 8	090991 FTP K8	1
FTP EK 10	090992 FTP K10	1

LOADS

Turbo aircrete anchor FTP K

Highest recommended loads¹⁾ for a single anchor in aerated concrete and gypsum blocks.

The given loads are valid for screws with the specified diameter.

Type			FTP K 4	FTP K 6	FTP K 8	FTP K 10
Wood screw diameter	\emptyset	[mm]	4	5-6	8	8-10
Min. edge distance	c_{min}	[mm]	100	100	150	200
Recommended loads in the respective base material F_{rec} ²⁾						
Aerated concrete	AAC 2 ($\geq 2,5$ N/mm ²)	[kN]	0,15	0,20	0,30	0,40
Aerated concrete	AAC 4 ($\geq 5,0$ N/mm ²)	[kN]	0,25	0,30	0,40	0,50
Gypsum block		[kN]	-	-	0,29	0,54

¹⁾ Required safety factors are considered.

²⁾ Valid for tensile load, shear load and oblique load under any angle.

The metal anchor for metric screws for aerated concrete



Wall consoles



Shelves

BUILDING MATERIALS

- Aerated concrete
- Solid panel made from gypsum

ADVANTAGES

- The Allen key chuck makes it possible to set the FTP M without the need for a special setting tool. This allows for a simple installation.
- The FTP M achieves a very high load-bearing capacity in aerated concrete for increased safety.
- The spiral-shaped outer thread taps itself into the aerated concrete with a positive fit. This means that it can be set without the need for much force.
- The special geometry allows for an almost expansion-force-free anchoring. This allows for small edge and spacing distances, and avoids splitting in the case of plastered surfaces.

APPLICATIONS

- Pictures
- Lighting
- Shelves
- Mirror cabinets
- Curtain rails
- Cable and pipe clips
- Stand-off installations
- Radiators
- TV consoles

FUNCTIONALITY

- The FTP M is suitable for pre-positioned installation.
- The aircrete anchor taps itself into the aircrete with a positive fit during the installation process.
- Suitable for metric screws with diameter 6 to 10 mm.
- For installation with a hexagon socket: Size of the hexagon socket corresponds to screw diameter, e.g. FTP M6 is installed with hexagon socket size 6.
- For installation with cordless screwdriver: use a low torque and use the correct 6-kt bit FTP EM.

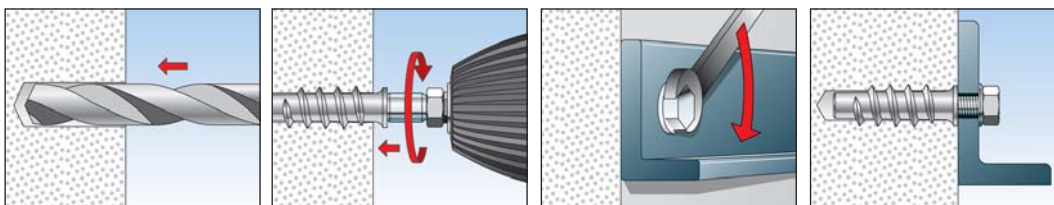

6
General fixings

TECHNICAL DATA



Turbo aircrete anchor **FTP M** (metal)

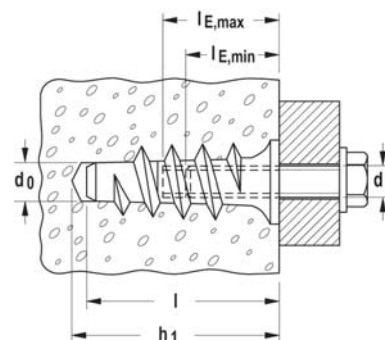

Item	Art.-No.	Drill hole diameter	Min. drill hole depth	Anchor length	Metric screw	Min. bolt penetration	Max. bolt penetration	Sales unit
		d_0 [mm]	h_1 [mm]	l [mm]	M	$l_{E,min}$ [mm]	$l_{E,max}$ [mm]	[pcs]
FTP M 6	078415 ¹⁾	8 - (10)	60	50	M 6	15	20	25
FTP M 8	078416 ¹⁾	10 - (12)	70	60	M 8	20	25	25
FTP M 10	078417 ¹⁾	12 - (14)	80	70	M 10	25	30	25

¹⁾ Values in brackets for drill hole diameter apply for aerated concrete, compressive strength of 5,0 N/mm² or higher.

ACCESSORIES



Setting tool **FTP EM**
for FTP M (metal)

Item	Art.-No.	Match	Sales unit
FTP EM 6	078577	FTP M6	1
FTP EM 8	078578	FTP M8	1
FTP EM 10	078579	FTP M10	1

LOADS

Turbo aircrete anchor FTP M

Highest recommended loads¹⁾ for a single anchor in aerated concrete and gypsum blocks.

The given loads are valid for metric screws with the specified thread size.

Type		FTP M 6	FTP M 8	FTP M 10	
Thread size	[M]	M 6	M 8	M 10	
Min. edge distance	c_{min} [mm]	100	150	200	
Recommended loads in the respective base material F_{rec}²⁾					
Aerated concrete	AAC 2 ($\geq 2,5$ N/mm ²)	[kN]	0,30	0,45	0,60
Aerated concrete	AAC 4 ($\geq 5,0$ N/mm ²)	[kN]	0,50	0,65	0,70
Aerated concrete	AAC 6 ($\geq 7,5$ N/mm ²)	[kN]	0,70	0,80	0,90
Gypsum block		[kN]	-	0,45	0,65

¹⁾ Required safety factors are considered.

²⁾ Valid for tensile load, shear load and oblique load under any angle.

The brass fixing for thin board building materials and solid building materials



Furniture fittings



Furniture hinges

BUILDING MATERIALS

- Wooden board building materials
- Plastic boards
- Concrete
- Solid brick
- Solid sand-lime brick
- Natural stone with dense structure

ADVANTAGES

- The short brass fixing PA 4 only requires a very low anchorage depth and is therefore the solution for thin board building materials.
- The special surface structure of the PA 4 prevents the fixing from rotating in the drill hole. This provides increased installation safety.
- The internal thread allows for the use of standard metric screws and enables the ideal adaptation to suit the intended use.

APPLICATIONS

- Handles
- Angle brackets
- Furniture fittings
- Lamps

FUNCTIONING

- The PA 4 is suitable for pre-positioned installation.
- Turning in the metric screw causes the front part of the brass fixing to expand, thus securely anchoring it in the substrate.
- Calculating screw length for flush fixing installation: Fixing length + fixture thickness = min. screw length

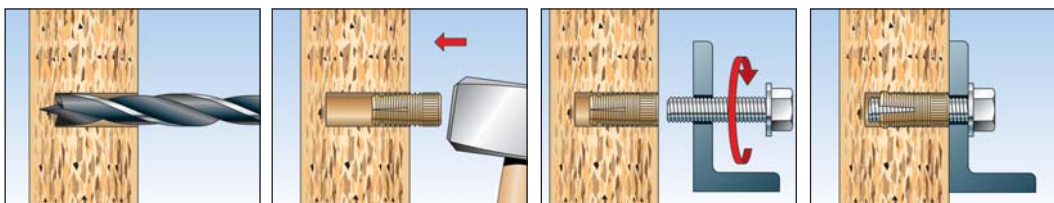

TECHNICAL DATA

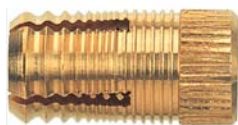

Brass fixing PA4

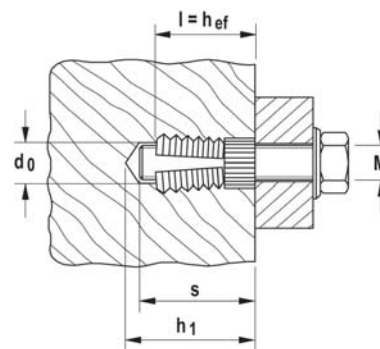

Item	Art.-No.	Drill hole diameter	Min. drill hole depth	Anchor length	Thread	Bolt penetration	Effect. anchorage depth	Sales unit
		d_0 [mm]	h_1 [mm]	l [mm]	M	s [mm]	h_{ef} [mm]	[pcs]
PA 4 M 6/7,5	050484 ¹⁾	8	7,5	7.5	M 6	7,5	7,5	200
PA 4 M 6/10,5	058484 ¹⁾	8	10,5	10.5	M 6	10,5	10,5	100
PA 4 M 6/13,5	059484 ¹⁾	8	13,5	13.5	M 6	13,5	13,5	100
PA 4 M 8/25	050485 ¹⁾	10	25	25	M 8	25	25	50
PA 4 M 10/25	050486 ¹⁾	12	25	25	M 10	25	25	25

¹⁾ Values of drill hole diameter apply for hard building materials. For soft building materials the drill diameter needs to be reduced by 0.5 mm.

LOADS

Brass fixing PA 4

Highest recommended loads¹⁾ for a single anchor.

The given loads are valid for metric screws with the specified thread size.

Type		PA 4 M 6/7,5	PA 4 M 6/10,5	PA 4 M 6/13,5	PA 4 M 8/25	PA 4 M 10/25
Thread size	[M]	M 6	M 6	M 6	M 8	M 10
Recommended loads in the respective base material F_{rec}²⁾						
Chipboard	[kN]	0,20	0,30	0,40	-	-
Fir wood	[kN]	0,18	0,25	0,38	-	-
Beech wood	[kN]	0,50	0,75	1,00	-	-
Plastic material	[kN]	0,75	1,50	2,00	-	-
Solid brick	Mz 12 [kN]	-	-	0,80	1,95	2,30

¹⁾ Required safety factors are considered.

²⁾ Valid for tensile load, shear load and oblique load under any angle.

For the rear-ventilated stand-off fastening of balcony cladding to hollow profiles

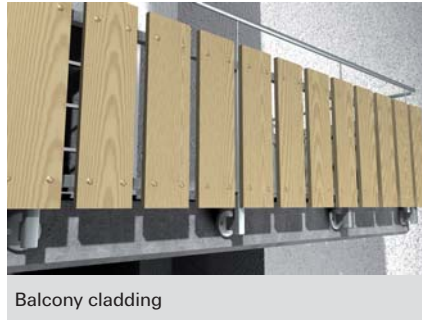

6
General fixings

BUILDING MATERIALS

- For fixing onto hollow metal profiles

ADVANTAGES

- The wide collar of the P9K plug fixes the balcony cladding to the hollow profile with a spacing. This avoids the formation of rot.
- The expansion within the railing post means that no second drilling on the opposite side of the post is necessary. This allows for a practically invisible fixing of the balcony cladding.
- The material quality of the P9K creates an elastic yet load-bearing connection. This allows for the absorption of thermal stresses, thus increasing the lifespan of the cladding.
- The short expansion element means that the balcony cladding fixing only requires a very small cavity. It is therefore suitable for narrow hollow profiles.

APPLICATIONS

- Balcony cladding
- Fittings
- Electrical switches
- Lamps
- Motion detectors

FUNCTIONING

- Turning in the screw causes the plug to expand in the hollow profile, thus ensuring a load-bearing connection.
- The wide collar prevents direct contact between the fixture and the hollow profile.

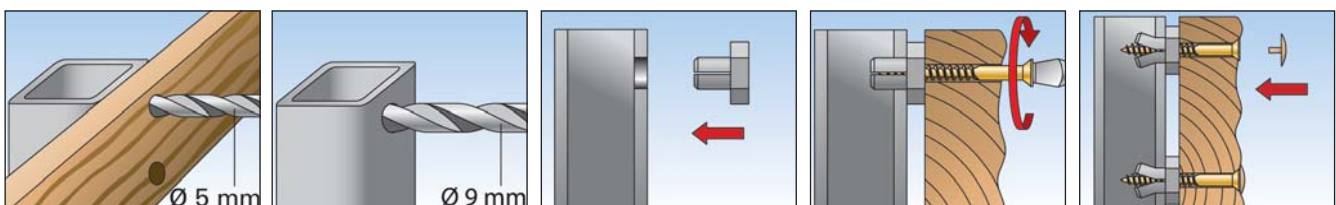

TECHNICAL DATA



Plug **P 9 K**

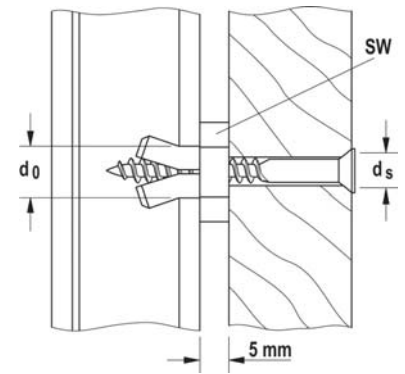

Item	Art.-No.	Drill hole diameter d_0 [mm]	Screw diameter d_s [mm]	Collar height [mm]	Width across nut ○ SW [mm]	Sales unit [pcs]
P 9 K	059395	9	5,0	5	15	50

LOADS

Balcony board fixing P 9 K

Highest recommended loads¹⁾ for a single anchor.

The given loads are valid for wood screws with the specified diameter.

Type			P 9 K
Screw diameter	Ø	[mm]	5
Recommended loads in the respective base material F_{rec}²⁾			
Wall thickness of hollow profile	2 mm	[kN]	0,27
Wall thickness of hollow profile	3 mm	[kN]	0,29
Wall thickness of hollow profile	4 mm	[kN]	0,31

¹⁾ Required safety factors are considered.

²⁾ Valid for tensile load, shear load and oblique load under any angle.

To fix wooden step treads in concrete and steel sub-structures

General fixings 6



BUILDING MATERIALS

- TB for fixing in:**
- Hollow steel profiles
- TBB for fixing in:**
- Concrete
 - Solid building materials

ADVANTAGES

- The elastic shaft geometry allows for the absorption of vibrations, prevents creaking, and thus increases comfort.
- The stair-tread fixing for steel sub-structures (TB) only requires a very small cavity due to the short expansion element. Thus it is suitable even for narrow steel profiles.

APPLICATIONS

- Wooden step treads

FUNCTIONING

- The plastic expansion plugs are suitable for anchoring wooden step treads and wooden boards >30 mm to steel profiles (TB) or in solid building materials (TBB).
- The ideal retention forces are only achieved when using cold wood glue for the fixing in wooden step treads.
- The plastic washers included with the TBB allow you to level out any unevenness in the substrate.

TECHNICAL DATA



Stair-tread fixing **TB** for installation on steel staircase stringers



Stair-tread fixing **TBB** for installation on concrete staircase stringers



Stair-tread fixing **TBZ 2** for centre-marking the stair-tread holes

Item	Art.-No.	Drill hole in stair thread [Ø mm]	Drill hole in steel staircase stringer [Ø mm]	Drill hole in concrete [Ø mm]	Collar height [mm]	Screw d _s x l _s [mm]	Width across nut ○ SW [mm]	Adapted for	Sales unit [pcs]
TB	060580	14 x 25	9	—	5	5 x 40	15	—	50
TBB	060583	14 x 25	—	8 x 55	—	5,5 x 70	—	—	50
TBZ 2	060584	—	—	—	—	—	—	TB and TBB	10

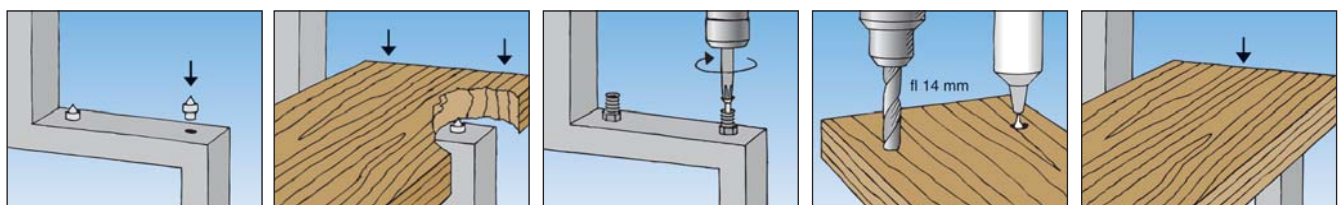

To repair over-sized or damaged drill holes



Repairing damaged drill holes



Repairing damaged drill holes

BUILDING MATERIALS

- Concrete
- Cavity floor slabs made from bricks and concrete
- Vertically perforated brick made from lightweight concrete
- Solid sand-lime brick
- Natural stone with dense structure
- Aerated concrete
- Solid brick made from lightweight concrete
- Solid brick

ADVANTAGES

- Using FIX IT means that you can avoid having to drill another hole, and makes it possible to reuse a pre-existing drill hole.
- The repair pad FIX IT can be used as a single layer or as multiple layers, and thus can be flexibly adapted to suit various drill hole sizes and shapes.
- The pad, which is covered with a special mortar, hardens after only approx. three minutes in the drill hole. This allows for a fast installation of the fixture.

APPLICATIONS

- To repair over-sized or damaged drill holes for use with plastic plugs

FUNCTIONING

- The pad, which is covered with a special mortar, hardens in the drill hole, thus anchoring the plug securely in the damaged or over-sized drill hole.
- Wet the pad with water, wrap it around the plug and push it into the damaged drill hole.
- After about three minutes the special pad will harden and the fixture can then be attached.
- Use several pads for larger tolerances.
- The curing time for the first pad is approx. three minutes. Add an additional minute for each additional pad used.

TECHNICAL DATA

Item	Art.-No.	Contents	Sales unit [pcs]
FIX IT	092507	card with 10 FIX IT pads	10

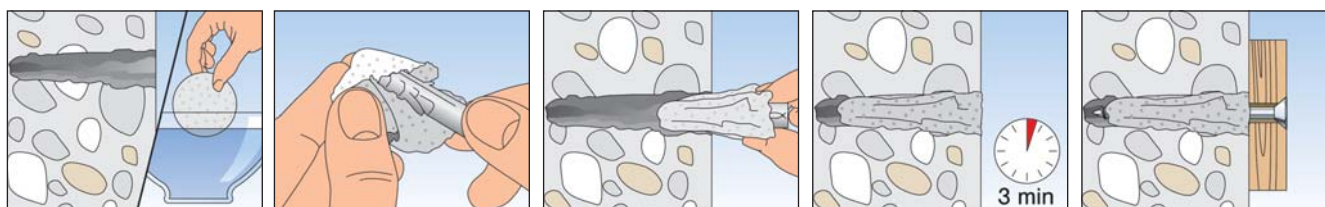

The installation-friendly doorstop

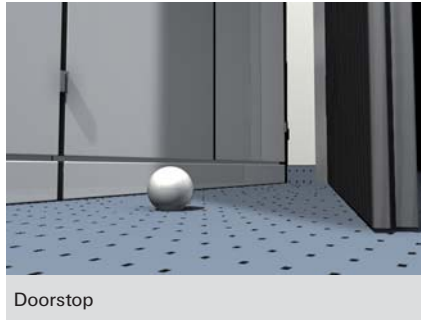

BUILDING MATERIALS

- Concrete
- Floor screed

CHARACTERISTICS



ADVANTAGES

- The extended plug shaft makes it possible to attach the doorstop directly, thus simplifying installation.
- The invisible fixing ensures visual appeal.
- The TS contains all the components required for installation and is therefore a convenient complete solution.
- The doorstop is available in a range of colours to suit every floor covering and individual design wishes.

APPLICATIONS

- Doorstop with flexible positioning

FUNCTIONING

- The doorstop TS is suitable for pre-positioned installation.
- When turning in the screw, the plug expands and anchors itself in the building material.
- The plug must be pushed into the drill hole up to the point where the plug shaft thickens.
- It can be removed by removing the doorstop, unscrewing the screw, and pulling out the plug.

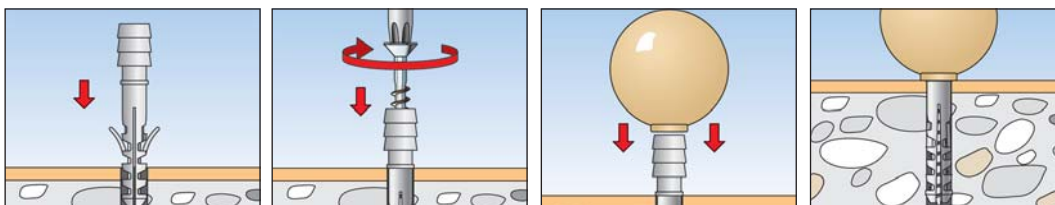

6
General fixings

TECHNICAL DATA



Doorstop **TS**









Doorstop assortment **TS-SORT**

Item	Art.-No.	Drill hole diameter d_0 [mm]	Min. drill hole depth h_1 [mm]	Colour	Contents	Sales unit [pcs]
TS 8 G	060535	8	50	grey	—	10
TS 8 W	060536	8	50	white	—	10
TS 8 S	060539	8	50	black	—	10
TS 8 BR	060540	8	50	brown	—	10
TS 8 BG	060551	8	50	beige	—	10
TS-SORT	060521	8	50	assortment	5 x grey, white, beige, black brown	1





7 Cavity fixings

		Page
Nylon toggle DUOTEC		394
Metal cavity fixing HM		397
Gravity- and spring-toggle K, KD, KDH, KM		400
Board fixing PD		404
Plasterboard fixing DUOBLADE		406
Plasterboard fixing GK		408
Plasterboard fixing GK GREEN		410
Plasterboard fixing metal GKM		412

Easy to install nylon toggle for high loads in all panel building materials

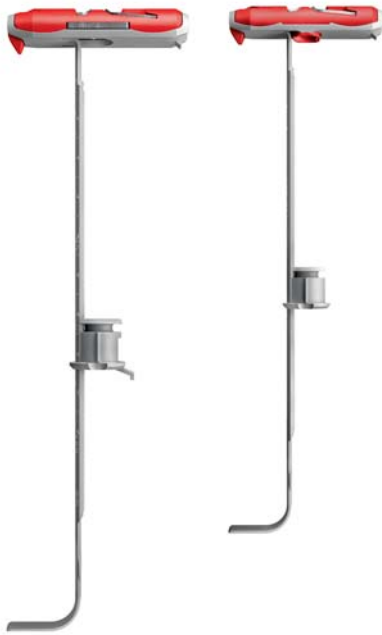

7
Cavity fixings

BUILDING MATERIALS

Suitable for:

- Gypsum plasterboard
- Gypsum fibreboard
- Wooden panels, such as OSB boards, chipboard, MDF sheets
- Steel plates
- Plastic boards
- Hollow blocks made from concrete

Also functioning in:

- Solid materials, such as concrete and wood

CERTIFICATES



ADVANTAGES

- Flexible screw mount allows for the use of screws and hooks with different thread shapes.
- Glass fibre-reinforced plastics and a metal skeleton insert (fischer DUOTEC 12) allow the toggle to handle heavy tensile and transverse loads in all panel building materials.
- Soft grey nylon contact surface distributes the load over the panel surface, thereby minimising weakening of the supporting building material.
- Standard drill hole diameters and short tilting element for easy installation in narrow cavities, including cavities with insulation.
- White flush sleeve with snap function allows the plug to be pre-installed quickly and securely in the drill hole.
- With scale on the grip strap (fischer DUOTEC 12) for determining the required screw length (scale value + 20 mm).

APPLICATIONS

- Kitchen hanging cabinets
- Living room cabinets
- Shelves
- Wardrobes
- Handrails
- Pictures
- Mirrors
- Lamps
- Heavy hanging baskets

FUNCTIONING

- The fischer DUOTEC is designed for pre-positioned installation.
- Simple installation with a standard diameter 10 or 12 mm drill bit.
- The short toggle element makes it suitable for narrow and even with mineral wool insulated cavities. Note the length of the toggle element!
- Functions like an expansion plug in solid building materials such as concrete or wood. Note, not with metric screws!
- Flexible screw insert allows for the use of wood, chipboard and metric screws and hooks.

INSTALLATION IN PLASTERBOARD AND CAVITY FIXINGS

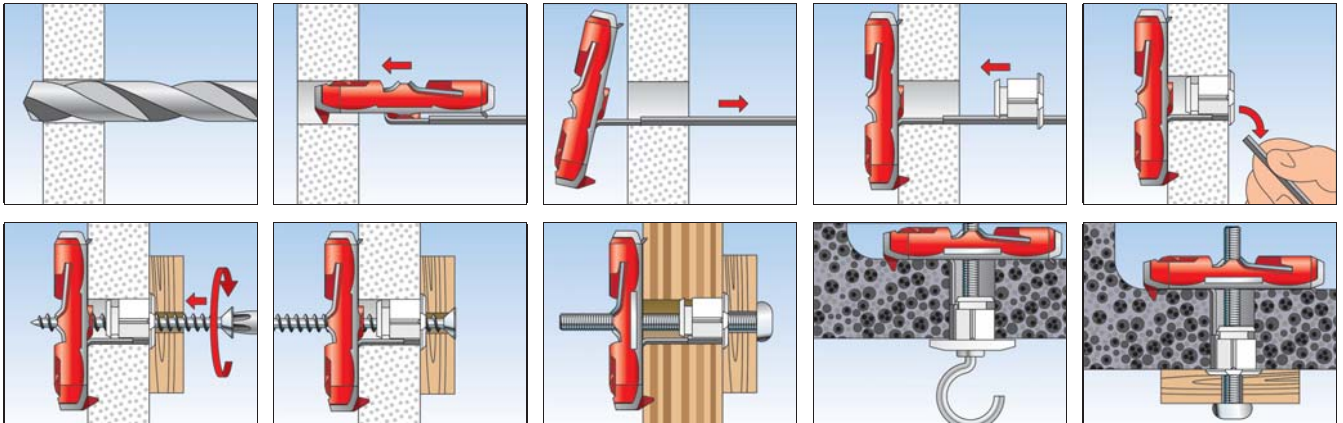

INSTALLATION HITTING IN SOLID MATERIALS

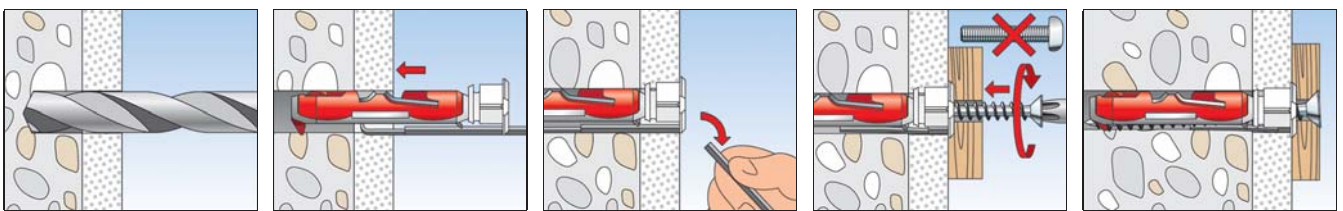

TECHNICAL DATA BOARD MATERIAL

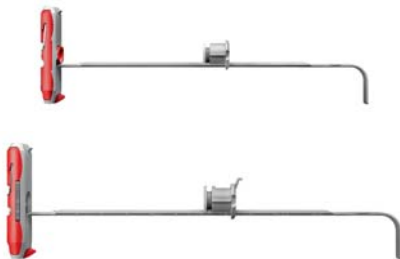

Nylon toggle **fischer DUOTEC 10**

Nylon toggle **fischer DUOTEC 12**

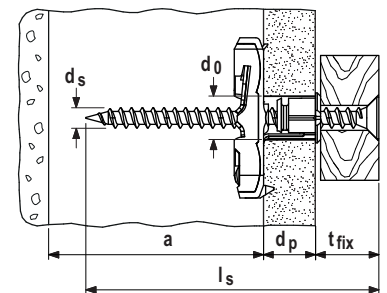

Item	Art.-No.	Drill hole diameter d_0 [mm]	Min. panel thickness d_p [mm]	Max. panel thickness d_p [mm]	Min. cavity depth a [mm]	Screw diameter d_s [mm]	Screw length l_s [mm]	Sales unit [pcs]
fischer DUOTEC 10	537258	10	12	55	40	4,5 - 5,0	$\geq d_p + t_{fix} + 20$	50
fischer DUOTEC 10 S	537259 ¹⁾	10	12	55	40	5,0	70	25
fischer DUOTEC 10 S PH	539025 ²⁾	10	12	55	40	5,0	70	25
fischer DUOTEC 12	542796	12	12	55	50	5,0 - 6,0 / M6	$\geq d_p + t_{fix} + 20$	10
fischer DUOTEC 12 S PH M	542797 ²⁾³⁾	12	12	55	50	M6	55	10
fischer DUOTEC 12 RH	542798 ⁴⁾	12	12	55	50	5,5	70	10

1) fischer DUOTEC S - with chipboard screw countersunk head

2) DUOTEC S PH - with chipboard screw panhead

3) fischer DUOTEC S PH - with machine screw panhead

4) fischer DUOTEC RH - with screw with round hook

TECHNICAL DATA HITTING IN SOLID MATERIALS

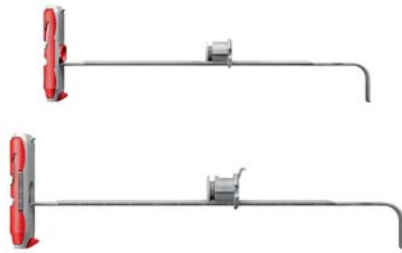

Nylon toggle **fischer DUOTEC 10**

Nylon toggle **fischer DUOTEC 12**

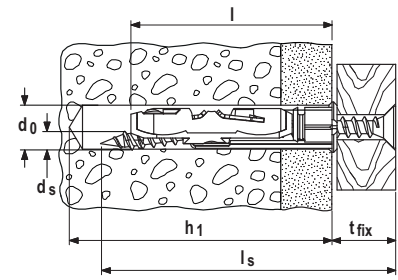

Item	Art.-No.	Drill hole diameter d_0 [mm]	Min. drill hole depth h_1 [mm]	Screw diameter [mm]	Min. screw length l_s [mm]	Anchor length l [mm]	Max. fixture thickness t_{fix} [mm]	Sales unit [pcs]
fischer DUOTEC 10	537258	10	$l_s - t_{fix} + 10$	4,5 - 5,0	$t_{fix} + 55$	50	$l_s - 55$	50
fischer DUOTEC 10 S	537259 ¹⁾	10	65	5,0	70	50	15	25
fischer DUOTEC 10 S PH	539025 ²⁾	10	65	5,0	70	50	15	25
fischer DUOTEC 12	542796	12	$l_s - t_{fix} + 10$	5,0 - 6,0	$t_{fix} + 65$	60	$l_s - 65$	10
fischer DUOTEC 12 RH	542798 ³⁾	12	75	5,5	55	60	-	10

- 1) fischer DUOTEC S - with chipboard screw countersunk head
- 2) DUOTEC S PH - with chipboard screw panhead
- 3) fischer DUOTEC RH - with screw with round hook

LOADS

Nylon toggle fischer DUOTEC

Highest recommended loads¹⁾⁴⁾ for a single anchor.

Type	fischer DUOTEC 10				fischer DUOTEC 12		
	Chipboard screw	Metrical screw	fischer Hook	Chipboard screw	Metrical screw	fischer Hook	
Screw diameter	[mm]	4,5	5	5	5	6	5,5
Recommended loads in the respective base material $F_{rec}^{2)}$ for a span in the construction $b = 625$ mm							
Gypsum plasterboard	9,5 mm	[kN]	0,17	0,17	0,17	0,17	0,17
Gypsum plasterboard	12,5 mm	[kN]	0,20	0,20	0,20	0,20	0,20
Gypsum plasterboard	2 x 12,5 mm	[kN]	0,43	0,43	0,43	0,43	0,43
Gypsum fibreboard	12,5 mm	[kN]	0,51	0,51	0,30 ³⁾	0,51	0,50 ³⁾
Chipboard	16 mm	[kN]	0,71	0,71	0,71	0,75	0,80
OSB board	18 mm	[kN]	0,75	0,75	0,75	0,75	1,30
Recommended loads in the respective base material $F_{rec}^{2)}$ for a span in the construction $b = 120$ mm							
Gypsum plasterboard	9,5 mm	[kN]	0,20	0,20	0,20	0,20	0,20
Gypsum plasterboard	12,5 mm	[kN]	0,36	0,36	0,36	0,36	0,36
Gypsum plasterboard	2 x 12,5 mm	[kN]	0,59	0,59	0,59	0,70	0,80
Gypsum fibreboard	12,5 mm	[kN]	0,75	0,75	0,75	0,80	1,10
Chipboard	16 mm	[kN]	0,75	0,75	0,75	0,80	1,40
OSB board	18 mm	[kN]	0,75	0,75	0,75	0,80	1,50
Recommended loads in solid building materials $F_{rec}^{2)}$							
Concrete	$\geq C20/25$	[kN]	0,45	0,75	-	0,30 ³⁾	0,40
Wood		[kN]	0,30	0,75	-	0,30 ³⁾	0,20
Recommended loads in the respective base material $F_{rec}^{2)}$							
Hollow block of lightweight aggregate concrete 'Sepa Parpaing'	$f_b \geq 8$ N/mm ²	[kN]	-	-	-	-	0,65
Pre-stressed hollow-core concrete slabs		[kN]	-	-	-	-	1,00
Hollow block of lightweight aggregate concrete Hbl acc. EN 771-3	$f_b \geq 2$ N/mm ²	[kN]	-	-	-	-	0,90

¹⁾ Required safety factors are considered.

²⁾ Valid for tensile load, shear load and oblique load under any angle.

³⁾ Bending of the hook is decisive. Only for tension load.

⁴⁾ The recommended loads are reference values and depending to the building material and the workmanship. The values are only valid for the given screw diameter.

The versatile metal cavity fixing with metric screws



Curtain rails



Shelves

BUILDING MATERIALS

- Gypsum plasterboard and gypsum fibreboards
- Cavity floor slabs
- Light building boards made of wood wool
- Chipboard
- Plywood boards

ADVANTAGES

- Due to the extensive range, the HM is suitable for board building materials with a thickness of 3-50 mm and thus suitable for a number of different applications.
- The metric internal thread allows the attachment to be removed and refitted several times, thus offering the best possible flexibility.
- The HM's expanding arms ensure a large supporting surface, thus allowing a high load-bearing capacity.
- The claws around the edge of the fixing penetrate the board building material, preventing the fixing from rotating, thus ensuring a secure installation.

APPLICATIONS

- Pictures
- Lighting
- Light shelves
- Towel rails
- Mirror cabinets
- Curtain rails
- Sub-structures

FUNCTIONING

- The metal cavity fixing HM is suitable for pre-positioned installation.
- The fixing should be selected based on the thickness of the board building material, to allow the very best expansion in the cavity.
- During installation, the expanding arms swing open and press onto the reverse side of the board.
- The HM can be installed using installation pliers. If using a battery operated screwdriver or screwdriver for installation, the pre-assembled screws must be removed first. When screwing in and expanding the fixing, the attachment, or a max. 6 mm plate, needs to be used as a turning stop.

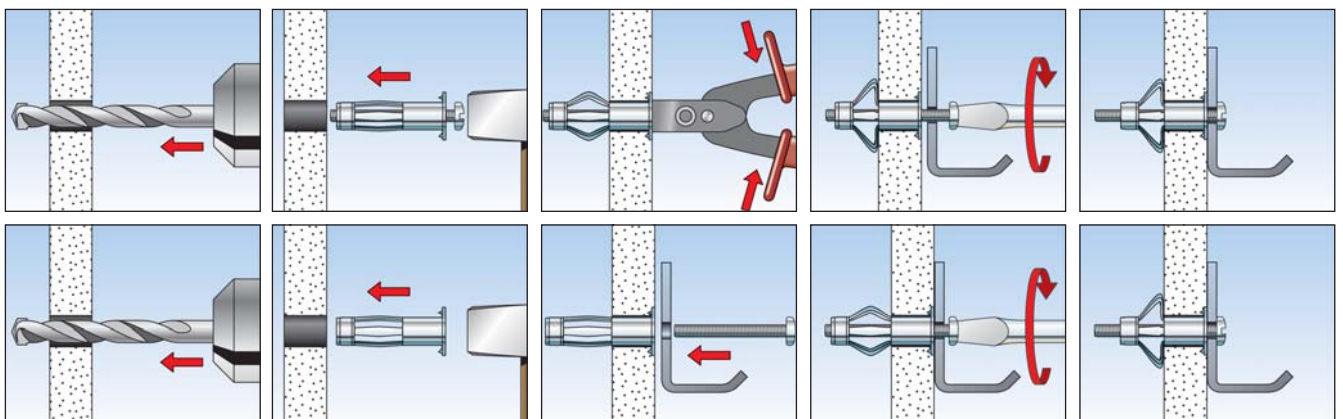

TECHNICAL DATA



HM-S with metric screw



HM-SS with hexagon headed screw



HM-H with angle hook

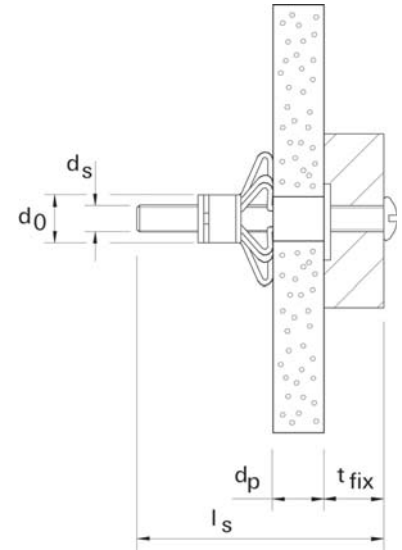

7
Cavity fixings

Item	Art.-No.	Drill hole diameter d_0 [mm]	Min. drill hole depth h_1 [mm]	Anchor length l [mm]	Screw $d_s \times l_s$ [mm]	Panel thickness d_p [mm]	Fixture thickness t_{fix} [mm]	Drive	Sales unit [pcs]
HM 4 x 32 S	519769	8	40	32	M 4 x 40	3 - 13	≤ 15 - 25	PH2	50
HM 4 x 45 S	519770	8	52	45	M 4 x 52	16 - 23	≤ 12 - 21	PH2	50
HM 4 x 60 S	519771	8	65	60	M 4 x 65	31 - 40	≤ 12 - 21	PH2	50
HM 5 x 37 S	519772	10	45	37	M 5 x 45	6 - 15	≤ 8 - 17	PH2	50
HM 5 x 52 S	519774	10	58	52	M 5 x 58	7 - 21	≤ 10 - 24	PH2	50
HM 5 x 65 S	519775	10	71	65	M 5 x 71	20 - 34	≤ 12 - 26	PH2	50
HM 6 x 37 S	519777	12	45	37	M 6 x 45	6 - 15	≤ 12 - 21	PH3	50
HM 6 x 52 S	519778	12	58	52	M 6 x 58	7 - 21	≤ 14 - 28	PH3	50
HM 6 x 65 S	519782	12	71	65	M 6 x 71	17 - 34	≤ 13 - 30	PH3	50
HM 6 x 80 S	519779	12	88	80	M 6 x 88	32 - 50	≤ 16 - 34	PH3	50
HM 8 x 54 SS	519783 1)	12	60	54	M 8 x 60	7 - 21	≤ 16 - 30	SW13	50
HM 4 x 32 H	519780	8	45	32	—	3 - 13	—	—	50
HM 5 x 65 H	519781	10	71	65	—	20 - 34	—	—	50

1) with hexagon headed screw, assembly only by using the professional installation tool HM Z 1

ACCESSORIES



HM Z 1 - the professional installation tool



HM Z 2 - the DIY installation tool

Item	Art.-No.	Adapted for	Sales unit [pcs]
HM Z 1	062320	HM 4 - HM 8	1
HM Z 2	062321	HM 4 - HM 6	1

LOADS

Metal cavity fixing HM

Highest recommended loads¹⁾ for a single anchor.

Type			HM 4 x 32 S	HM 4 x 46 S	HM 5 x 37 S	HM 5 x 52 S	HM 5 x 65 S	HM 6 x 37 S	HM 6 x 52 S	HM 6 x 65 S	HM 8 x 55 SS
Thread size	[M]		M4	M4	M5	M5	M5	M6	M6	M6	M8
Recommended loads in the respective base material F_{rec}²⁾											
Gypsum plasterboard	9,5 mm	[kN]	0,15	0,15	0,15	0,15	-	0,15	-	-	-
Gypsum plasterboard	12,5 mm	[kN]	0,20	0,20	0,20	0,20	-	0,20	0,20	-	0,20
Gypsum plasterboard	19 mm (2 x 9,5 mm)	[kN]	-	-	-	0,25	-	-	0,25	-	0,25
Gypsum plasterboard	25 mm (2 x 12,5 mm)	[kN]	-	-	-	-	0,30	-	-	0,30	-
Chipboard	10 mm	[kN]	0,25	0,25	0,25	0,25	-	0,25	0,25	-	0,25
Chipboard	13 mm	[kN]	0,25	0,25	0,25	0,25	-	0,25	0,25	-	0,25
Chipboard	28 mm	[kN]	-	-	-	-	0,50	-	-	0,50	-
Plywood	4 mm	[kN]	0,10	-	-	-	-	-	-	-	-
Hardboard	3 mm	[kN]	0,10	-	-	-	-	-	-	-	-
Wood wool slab	16 mm	[kN]	-	0,05	-	0,05	-	-	0,05	-	0,05
Wood wool slab	25 mm	[kN]	-	-	-	-	0,05	-	-	0,05	-
Fibre cement board	8 mm	[kN]	0,25	0,25	0,25	0,25	-	0,25	-	-	-
Gypsum fibreboard	10 mm	[kN]	0,25	0,25	0,25	0,25	-	0,25	0,25	-	0,25
Gypsum fibreboard	15 mm	[kN]	-	0,25	0,25	0,25	-	0,25	0,25	-	0,25

¹⁾ Required safety factors are considered.

²⁾ Valid for tensile load, shear load and oblique load under any angle.

The cavity fixing for different board thicknesses and large usage lengths



Ceiling lamps



Wash basins

7
Cavity fixings

BUILDING MATERIALS

- Gypsum plasterboard and gypsum fibreboards
- Cavity floor slabs made from bricks and concrete
- Chipboard
- Plywood boards

CERTIFICATES



ADVANTAGES

- Universal fixing for fastenings in a wide range of drywall and hollow wall materials.
- When the metal crosspiece is pushed through the drill hole, pull it firmly against the inner wall cavity by tugging the plastic pull ring on the outer wall.
- Afterwards cut the plastic legs off and fasten the fixture with e.g. a screw or screw in a hook or an eyebolt according to your demands.
- Suitable for pre-positioned installation.

APPLICATIONS

- Pictures
- Lighting
- Light shelves
- Towel rails
- Mirror cabinets
- Light cabinets
- Wash basins and urinals (KM 10)
- Cable and pipe clips

FUNCTIONING

- The gravity and spring toggle are suitable for pre-positioned installation.
- When placed in the drill hole, the bearing elements of the gravity and spring toggles independently swing open behind the board.
- The KM 10 is specially suited to fixing wash basins and urinals into installation and cavity walls.
- No special installation tool required. For a fast and convenient installation.

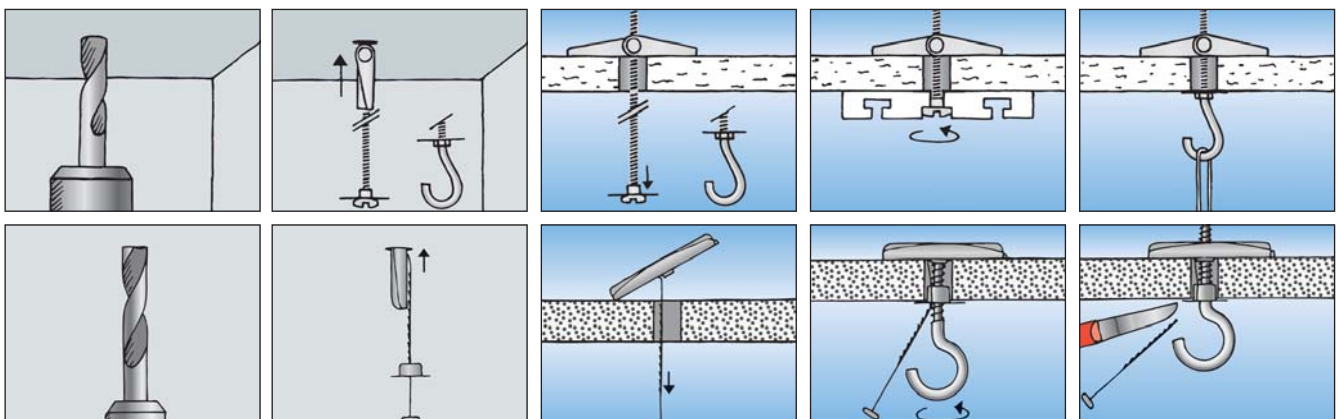

TECHNICAL DATA



Nylon toggle **K 54**

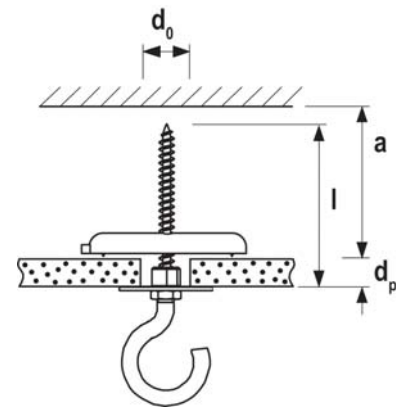

Item	Art.-No.	Drill hole diameter d_0 [mm]	Max. panel thickness d_p [mm]	Min. cavity depth a [mm]	Anchor length l [mm]	Thread $\emptyset \times \text{length}$ [mm]	Sales unit [pcs]
K 54	050323	10	65	58	125	woodscrew 4mm	25

TECHNICAL DATA



Spring toggle **KD 3 + 4**



Spring toggle with hook **KDH 3 + 4**

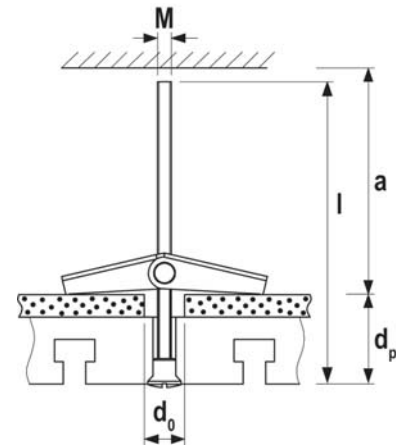

Item	Art.-No.	Drill hole diameter d_0 [mm]	Max. panel thickness d_p [mm]	Min. cavity depth a [mm]	Anchor length l [mm]	Thread $\emptyset \times \text{length}$ [mm]	Sales unit [pcs]
KD 3	080181	12	65	27	95	M 3 x 90	50
KDH 3	080182	12	51	27	105	M 3 x 80	25
KD 3 B	080192	12	65	27	95	M 3 x 90	10
KD 4	080183	14	69	34	105	M 4 x 100	25
KDH 4	080184	14	35	34	95	M 4 x 70	25
KD 4 B	080193	14	69	34	105	M 4 x 100	10

TECHNICAL DATA

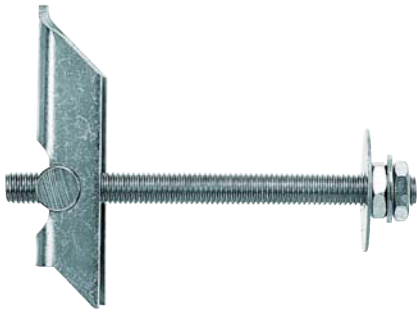

Gravity toggle **KD 5 + 6 + 8**

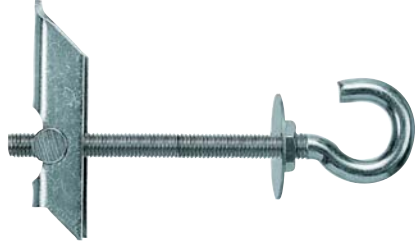

Gravity toggle with hook **KDH 5 + 6 + 8**

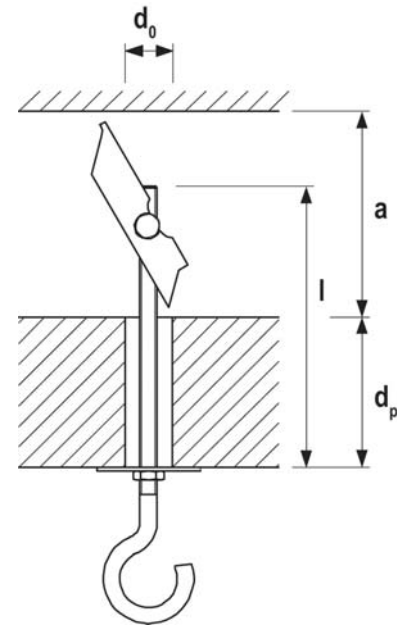

7
Cavity fixings

Item	Art.-No.	Drill hole diameter d_0 [mm]	Max. panel thickness d_p [mm]	Min. cavity depth a [mm]	Anchor length l [mm]	Thread $\emptyset \times \text{length}$ [mm]	Sales unit [pcs]
KD 5	080187	16	63	70	100	M 5 x 100	25
KDH 5	080188	16	60	70	130	M 5 x 90	20
KD 6	080185	16	63	70	100	M 6 x 100	25
KDH 6	080186	16	60	70	130	M 6 x 100	20
KD 8	080178	20	55	75	100	M 8 x 100	20
KDH 8	080179	20	55	75	130	M 8 x 100	20

TECHNICAL DATA

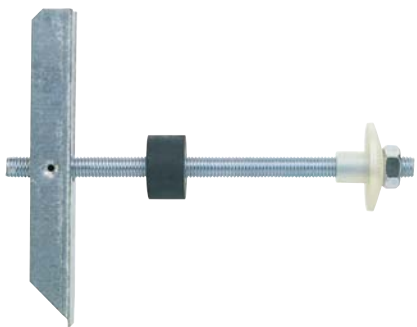

Gravity toggle **KM 10**

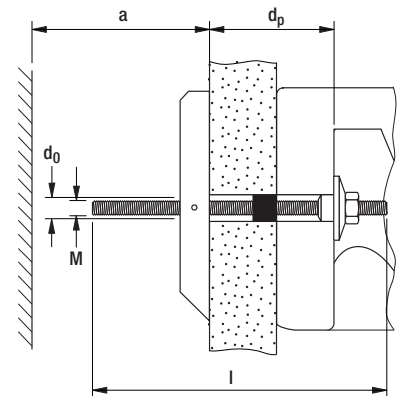

Item	Art.-No.	Drill hole diameter d_0 [mm]	Max. panel thickness d_p [mm]	Min. cavity depth a [mm]	Anchor length l [mm]	Screw $d_s \times l_s$ [mm]	Sales unit [pcs]
KM 10	050326	30	90	140	180	M 10 x 180	25

LOADS

Toggle fixing KD

Highest recommended loads¹⁾ for a single anchor.

Type			KD3	KD4	KD5	KD6	KD8	KDH3	KDH4	KDH5	KDH6	KDH8
Thread size	[M]		M3	M4	M5	M6	M8	M3	M4	M5	M6	M8
Recommended loads in the respective base material F_{rec}²⁾												
Gypsum plasterboard	12,5 mm	[kN]	0,15	0,15	0,15	0,15	0,18	0,07 ³⁾	0,13 ³⁾	0,15	0,15	0,18
OSB board	≥15 mm	[kN]	0,34	0,58	0,85	0,85	0,89	0,07 ³⁾	0,13 ³⁾	0,30 ³⁾	0,45 ³⁾	0,89

¹⁾ Required safety factors are considered.

²⁾ Valid for axial tensile load.

³⁾ Bending of the hook is decisive. Only for tension load.

LOADS

Toggle fixing KM10 and K54

Mean ultimate loads

Type			KM10	K54
Screw diameter			M10	4mm
Mean ultimate loads F_u^{1) 2) 3)}	[kN]		13,0	0,8

¹⁾ Upon these failure loads an appropriate safety factor has to be considered.

²⁾ Valid for tensile load, shear load and oblique load under any angle.

³⁾ If the failure of the base material is not possible.

The expansion plug for fixings in gypsum plasterboard, gypsum fibreboard and wooden panels



Towel rails



Small shelves

7
Cavity fixings

BUILDING MATERIALS

- Gypsum plasterboard and gypsum fibreboards
- Wooden boards
- MDF boards
- Multiplex boards
- OSB boards
- Plywood boards
- Chipboard
- Wood core plywood boards

CERTIFICATES



ADVANTAGES

- The operating principle of the fixing allows for use in various board thicknesses, including in low cavity depths. This provides great flexibility.
- The special fixing geometry with a nylon cone ensures a high tightening torque that can be identified immediately. This offers a high level of installation safety.
- The longitudinal ribs prevent the fixing from rotating in the drill hole, thus allowing for a reliable installation.
- The board fixing PD can be used with the most wide-ranging screws, hooks and eye screws. This allows for a broad range of applications.

APPLICATIONS

- Pictures
- Lighting
- Light shelves
- Towel rails
- Mirror cabinets
- Curtain rails

FUNCTIONING

- The board fixing PD is suitable for pre-positioned installation.
- Use rotary drilling to create the drill hole.
- When the screw is tightened, the plastic cone is pulled into the sleeve and expands the fixing.
- Use full-thread screws, or alternatively, the part of the screw without thread may not be longer than the thickness of the item being attached.
- Do not use screws with double-start threads.

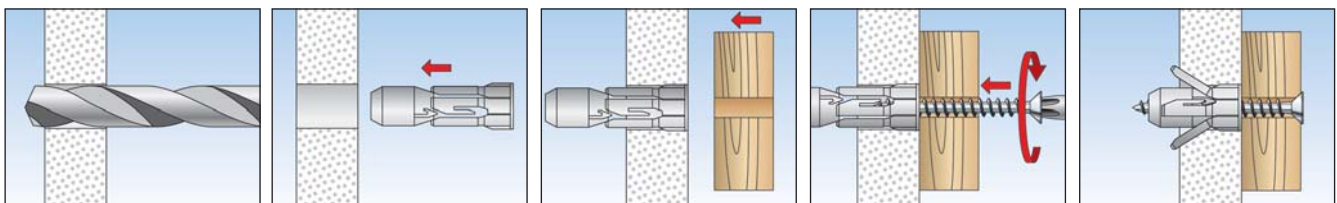

TECHNICAL DATA



Board fixing **PD**



Board fixing **PD S** - with chipboard screw

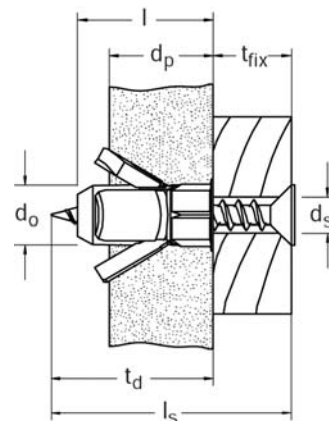

Item	Art.-No.	Drill hole diameter	Min. drill hole depth	Min. panel thickness	Anchor length	Chipboard screw	Max. fixture thickness	Sales unit
		d_0 [mm]	h_1 [mm]	d_p [mm]	l [mm]	$d_s / d_s \times l_s$ [mm]	t_{fix} [mm]	[pcs]
PD 8	024771	8	31	6	29	4	—	100
PD 10	015935	10	30	7	28	5	—	100
PD 12	015937	12	29	9	27	6	—	50
PD 8 S	024772 ¹⁾	8	31	6	29	4 x 40	11	50
PD 10 S	015936 ¹⁾	10	30	7	28	5 x 40	12	50
PD 12 S	015938 ¹⁾	12	29	9	27	6 x 50	22	25

¹⁾ PD-S with chipboard screw.

LOADS

Board fixing PD

Highest recommended loads¹⁾ for a single anchor.

The given loads are valid for chipboard screws with the specified diameter.

Type		PD 8	PD 10	PD 12
Chipboard screw	\emptyset [mm]	4	5	6
Recommended loads in the respective base material F_{rec}²⁾				
Gypsum plasterboard	9,5 mm [kN]	0,10	0,10	0,10
Gypsum plasterboard	12,5 mm [kN]	0,10	0,10	0,15
Gypsum plasterboard	2 x 12,5 mm [kN]	0,15	0,15	0,15
Gypsum fibreboard	12,5 mm [kN]	0,20	0,25	0,30
Plywood	[kN]	0,15	0,40	0,80
Chipboard	16 mm [kN]	0,25	0,25	0,25

¹⁾ Required safety factors are considered.

²⁾ Valid for tensile load, shear load and oblique load under any angle.

The self-drilling plasterboard plug for fast and easy installation



Smoke detectors



Mirrors

BUILDING MATERIALS

- Gypsum plasterboard, single and double-planked
- Gypsum fibreboard
- Lightweight cement boards

CERTIFICATES



ADVANTAGES

- An innovative product of the fischer DUO-Line with intelligent combinations for more power and more intelligence.
- The self-drilling fischer DUOBLADE allows fast and easy installation in gypsum plasterboard and gypsum fibreboard.
- The black metal tip guarantees simple and safe installation.
- High torque when anchor is installed for the feelgood-factor and an optimum feeling when setting.
- PZ 2 drive - same drive for plug and screw.

APPLICATIONS

- Smoke detectors
- Mirrors
- Curtain rods
- Blinds
- Lamps
- Pictures

FUNCTIONING

- The fischer DUOBLADE is suitable for pre-positioned installation.
- The metal tip for better heat-resistant and cutting characteristics. Especially in double-layered plasterboard.
- The fischer DUOBLADE can be used with wood, metal and chipboard screws of Ø4.0 to Ø5.0 mm.

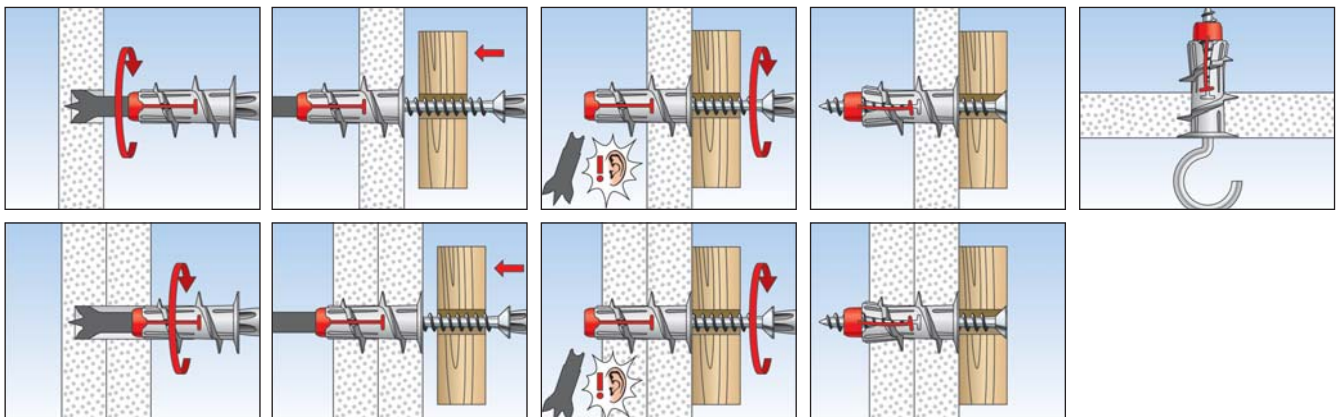

TECHNICAL DATA



DUOBLADE

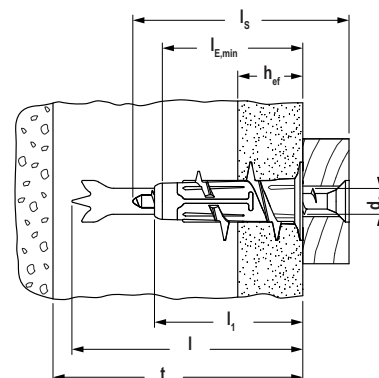

Item	Art.-No.	Min. thickness to first supporting layer t [mm]	Anchor length l [mm]	Anchor length without drill tip l ₁ [mm]	Anchorage depth h _{ef} [mm]	Min. bolt penetration l _{E,min} [mm]	Wood and chipboard screws d _s / d _s x l _s [mm]	Drive	Sales unit [pcs]
DUOBLADE	545675	50	44	29	9,5 - 25	28	4 - 5	—	50
DUOBLADE S	545676 ¹⁾	50	44	29	9,5 - 25	28	4,5 x 40	PZ2	25
DUOBLADE K NV	545683	50	44	29	9,5 - 25	28	4 - 5	—	10
DUOBLADE S K NV	545684 ¹⁾	50	44	29	9,5 - 25	28	4,0 x 46	PZ2	6
DUOBLADE WH K NV	545685 ²⁾	50	44	29	9,5 - 25	28	4,2 x 40	—	6
DUOBLADE RH K NV	545686 ³⁾	50	44	29	9,5 - 25	28	4,5 x 40	—	6

1) With chipboard screw countersunk head.

2) With screw with angle hook.

3) With screw with round hook.

LOADS

Plasterboard fixing DUOBLADE

Highest recommended loads¹⁾ for a single anchor.

The given loads are valid for chipboard screws with the specified diameters.

Type			DUOBLADE
Chipboard screw	Ø	[mm]	4,0 - 5,0
Recommended loads in the respective base material F_{rec} ²⁾			
Gypsum plasterboard	9,5 mm	[kN]	0,08
Gypsum plasterboard	12,5 mm	[kN]	0,10
Gypsum plasterboard (e.g. Knauf Diamant board or Rigips Die Harte)	12,5 mm	[kN]	0,18
Gypsum plasterboard	2 x 12,5 mm	[kN]	0,20
Lightweight Cement Board	12,5 mm	[kN]	0,08
Gypsum fibreboard	12,5 mm	[kN]	0,34

¹⁾ Required safety factors are considered.

²⁾ Valid for tensile load, shear load and oblique load under any angle.

The fastest installation in gypsum plasterboard



Wall lamps



Pictures

7
Cavity fixings

BUILDING MATERIALS

- Gypsum plasterboard, single and double-planked

CERTIFICATES



ADVANTAGES

- The included setting tool combines the drilling and fixing setting functions. It thus allows for a fast and simple installation.
- The sharp, self-tapping thread of the GK enables a secure, positive fit fixing. This achieves a high load-bearing capacity.
- The short fixing length means that only a small amount of space is required behind the board. As a result, the GK can also be used in the case of unknown board thickness and cavity depth.
- The cross-drive recess in the head of the fixing means that the GK can also be screwed out like a screw without a setting tool.
- The GK can be used with the most wide-ranging screws, hooks and eye screws. This allows for a broad range of applications.

APPLICATIONS

- Pictures
- Lighting
- Electrical installations
- Fitting accessories
- Series installations

FUNCTIONING

- The gypsum plasterboard fixing GK is suitable for pre-positioned installation.
- The GK is screwed flush into the gypsum plasterboard using the setting tool provided. Overtightening the fixing should be avoided. Therefore, the installation torque should be limited when using a battery operated screwdriver.
- Adapted for wood, self-tapping and chipboard screws of 4.0 to 5.0 mm diameter.
- For board thicknesses greater than 15 mm, drill a hole first by using the setting tool.
- Not suitable for gypsum fibreboard and tiled plasterboard.

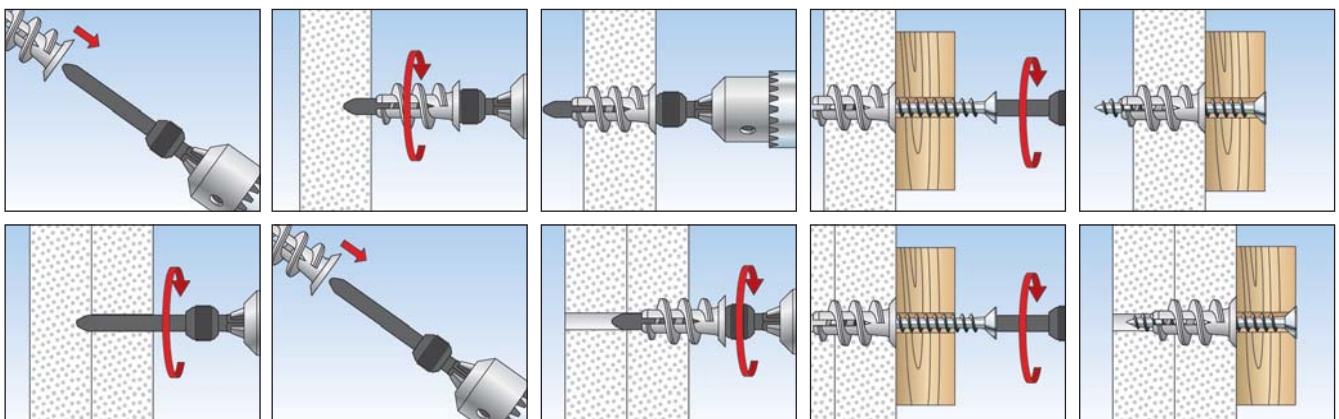

TECHNICAL DATA



Plasterboard fixing **GK**



Plasterboard fixing **GKS**

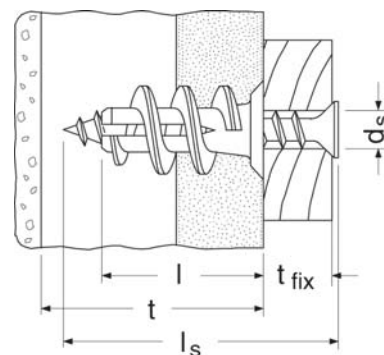

Item	Art.-No.	Anchor length l [mm]	Min. thickness to first supporting layer t [mm]	Max. fixture thick- ness t _{fix} [mm]	Screw d _s x l _s [mm]	Drive	Sales unit [pcs]
GK	052389 ¹⁾²⁾	22	25	—	4,0 - 5,0 x L _s	—	100
GK S	052390 ¹⁾³⁾	22	25	13	4,5 x 35	PZ2	50

1) Including installation tool GWK.

2) Min. screw length = length of plug 22 mm + thickness of building component.

3) Supplied with plasterboard screw.

ACCESSORIES



Installation tool **GWK**



PROFI-BOX GK

Item	Art.-No.	Contents	Sales unit [pcs]
GWK	052393	-	10
PROFI-BOX GK	518528	50 Plasterboard fixings GK, 1 Installation tool, 38 Chipboard screws 4,5 x 35, 6 Angle hooks 4,2 x 40, 6 Round hooks 4 x 46	1

LOADS

Plasterboard fixing GK

Highest recommended loads¹⁾ for a single anchor.

The given loads are valid for chipboard screws with the specified diameter.

Type			GK
Chipboard screw	∅	[mm]	4,0 - 5,0
Recommended loads in the respective base material F_{rec} ²⁾			
Gypsum plasterboard	9,5 mm	[kN]	0,07
Gypsum plasterboard	12,5 mm	[kN]	0,08
Gypsum plasterboard	2 x 12,5 mm	[kN]	0,11

¹⁾ Required safety factors are considered.

²⁾ Valid for tensile load, shear load and oblique load under any angle.

The fastest installation in gypsum plasterboard



Wall lamps



Pictures

7

Cavity fixings

BUILDING MATERIALS

- Gypsum plasterboard, single and double-planked

CERTIFICATES



ADVANTAGES

- Produced with at least 50% renewable raw materials and therefore particularly environmentally friendly.
- Just as effective, secure and durable as regular GK plugs.
- The included setting tool combine the functions of drilling and setting fixings for direct and easy installation.
- Sharp, self-tapping thread for a positive-fit connection with a high load-bearing capacity.
- The cross-drive recess in the head of the fixing means that the GK GREEN can also easily be screwed out like a screw.
- The GK GREEN can be used with various screws, hooks and eye screws, making it very versatile in its applications.

APPLICATIONS

- Pictures
- Lighting
- Electrical installations
- Fitting accessories
- Series installations

FUNCTIONING

- The gypsum plasterboard fixing GK GREEN is suitable for pre-positioned installation.
- The GK GREEN is screwed flush into the gypsum plasterboard using the setting tool provided. Avoid manual and machine-aided overtightening.
- For board thicknesses greater than 15 mm, drill a hole first by using the setting tool.
- Adapted for wood, sheet metal and chipboard screws with a diameter of 4.0 to 5.0 mm.
- Not suitable for gypsum fibreboard and tiled plasterboard.

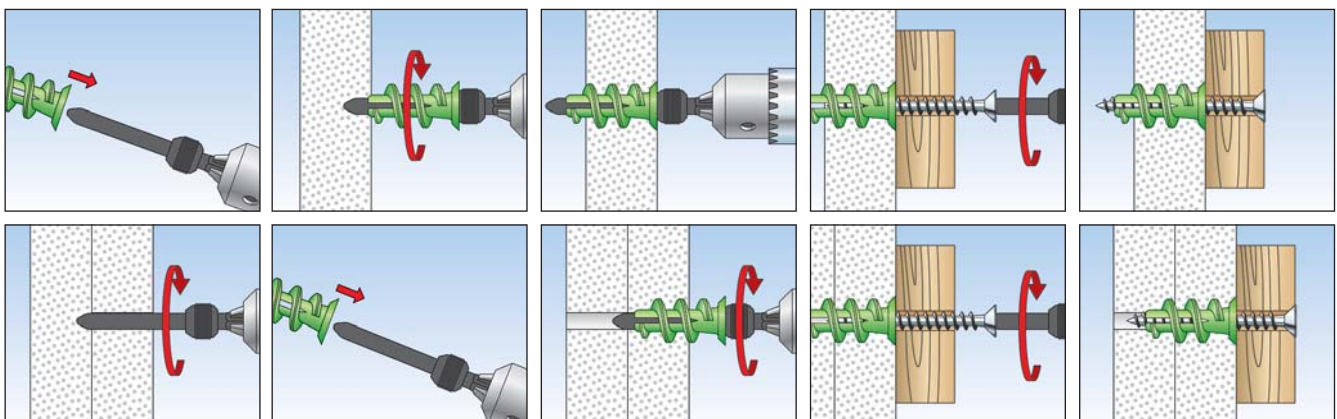

TECHNICAL DATA

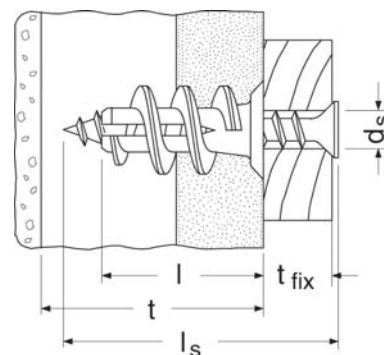

Item	Art.-No.	Anchor length l [mm]	Min. thickness to first supporting layer t [mm]	Max. fixture thick- ness t _{fix} [mm]	Screw d _s x l _s [mm]	Drive	Sales unit [pcs]
GK GREEN	524868 ^{1) 2)}	22	25	—	4,0 - 5,0 x L _s	—	90
GK GREEN S	524869 ^{1) 3)}	22	25	13	4,5 x 35	PZ2	45

1) Including installation tool GKW.

2) Min. screw length = length of plug 22 mm + thickness of building component.

3) Supplied with plasterboard screw.

ACCESSORIES



Item	Art.-No.	Sales unit [pcs]
GKW	052393	10

LOADS

Plasterboard fixing GK GREEN

Highest recommended loads¹⁾ for a single anchor.

The given loads are valid for chipboard screws with the specified diameter.

Type	GK GREEN	
Chipboard screw	Ø [mm]	4,0 - 5,0
Recommended loads in the respective base material F_{rec}²⁾		
Gypsum plasterboard	9,5 mm [kN]	0,07
Gypsum plasterboard	12,5 mm [kN]	0,08
Gypsum plasterboard	2 x 12,5 mm [kN]	0,11

¹⁾ Required safety factors are considered.

²⁾ Valid for tensile load, shear load and oblique load under any angle.

The self-tapping metal fixing for gypsum plasterboard and gypsum fibreboard



Wall lamps



Speaker cabinets

BUILDING MATERIALS

- Gypsum fibreboard
- Gypsum plasterboard

ADVANTAGES

- Due to its material properties, the GKM can be used in gypsum plasterboard and gypsum fibreboard, and can be used with the most wide-ranging screws, hooks and eye screws. This allows for a broad range of applications.
- The sharp, self-tapping thread enables a secure, positive fit fixing. This achieves a high load-bearing capacity.
- The cross-drive recess means that a standard screwdriver or bit can be used. No special setting tool is required.
- The short fixing length means that only a small amount of space is required behind the board. As a result, the GKM can also be used in the case of unknown board thickness and cavity depth.

APPLICATIONS

- Pictures
- Lighting
- Electrical installations
- Fitting accessories

FUNCTIONING

- The GKM is suitable for pre-positioned installation.
- The self-tapping metal fixing GKM taps itself into the plasterboard with a positive fit.
- Flush installation in the board building material. Overtightening the fixing should be avoided. Therefore, the installation torque should be limited when using a battery operated screwdriver.
- Adapted for wood, self-tapping and chipboard screws of 4.0 to 5.0 mm diameter.
- Pre-drill with a \varnothing 8 mm drill bit when using gypsum fibreboard and double-planked gypsum plasterboard.
- Not suitable for tiled plasterboard.

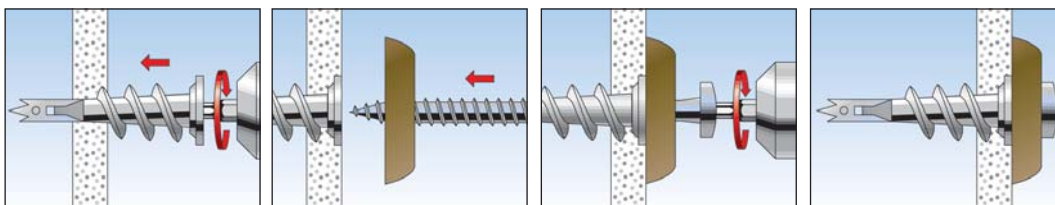

TECHNICAL DATA



Plasterboard fixing metal **GKM**

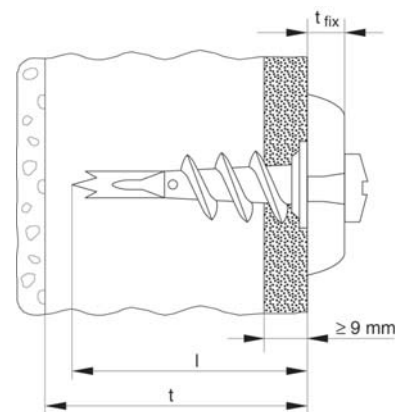

Item	Art.-No.	Anchor length l [mm]	Min. thickness to first supporting layer t [mm]	Max. fixture thick- ness t _{fix} [mm]	Screw d _s x l _s [mm]	Drive	Sales unit [pcs]
GKM	024556	31	35	—	4,0 - 5,0 x Ls	—	100
GKM 12	040432 ¹⁾	31	35	12	4,5 x 35	PZ2	100
GKM 27	040434 ²⁾	31	35	27	4,5 x 50	PZ2	100

¹⁾ Supplied with plasterboard screws panhead.

²⁾ Supplied with plasterboard screws countersunk head.

LOADS

Plasterboard fixing metal GKM

Highest recommended loads¹⁾ for a single anchor.

The given loads are valid for chipboard screws with the specified diameter.

Type			GKM
Chipboard screw	∅	[mm]	4,0 - 5,0
Recommended loads in the respective base material F_{rec} ²⁾			
Gypsum plasterboard	9,5 mm	[kN]	0,07
Gypsum plasterboard	12,5 mm	[kN]	0,08
Gypsum plasterboard	2 x 12,5 mm	[kN]	0,11

















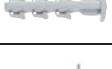

¹⁾ Required safety factors are considered.

²⁾ Valid for tensile load, shear load and oblique load under any angle.



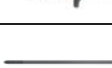
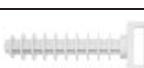

8 Electrical fixings

		Page
Locking clip SCN		416
Pipe clip RC		418
Pipe clip FC		420
Saddle clip SCH		422
Fastening tie FF		424
ClipFix plus LS/ES/ZS		426
ClipFix plus SD		428
Cable clasp KB		430
Cable harness SHA		432
Multi cable support metal SHA M		434
Wall slot clip FWSC		436
Nail disc NSB		437
Nail clip NS/MNS		439
Spacer pipe clamp AM		441
Conduit clip BSM		443
Textile web strapping GWB		445
Perforated steel banding LBV / LBK		446
Impact nail ED		447
Cable tie BN/UBN		449
Cable tie plug FCTP		451
Wireclip		452

The easy-to-install and secure locking clip for fixing of pipes



Plastic pipes



Plastic pipes

BUILDING MATERIALS

When using 2-component DUOPOWER plug:

- Concrete
- Solid brick
- Solid sand-lime brick
- Aerated concrete
- Vertically perforated brick
- Perforated sand-lime brick
- Plasterboard
- Gypsum plasterboard and gypsum fibreboards
- Hollow blocks made from lightweight concrete
- Cavity floor slabs made from bricks and concrete or similar
- Natural stone
- Chipboard
- Solid panel made from gypsum
- Solid brick made from lightweight concrete

CHARACTERISTICS



ADVANTAGES

- When pressing, the locking clip SCN automatically embraces and locks the pipe, thus enabling convenient installation.
- The mechanical lock provides a secure and reopenable fixing.
- The integrated slotted hole allows for an easy and adjustable installation.
- The double-sided couplings allow several clips to be coupled together. This saves installation time and money.
- Flexible mounting with plugs and screws or with 11 mm C-profile rails.
- The durable nylon material is halogen- and silicone-free, allows year-round use even under frost and thus ensures a high level of safety.

APPLICATIONS

- Plastic, empty pipes
- Flexible and rigid electric tubes
- Aluminium-, copper- and steel pipes

FUNCTIONING

- The locking clip SCN is fixed in pre-positioned installation with a suitable plug and screw or in 11 mm C-profile rails.
- Due to the mechanical locking, the pipes are securely fixed with the clip.
- Installation temperature -20 °C + 60 °C
- Temperature resistance when installed -40 °C to +80 °C.

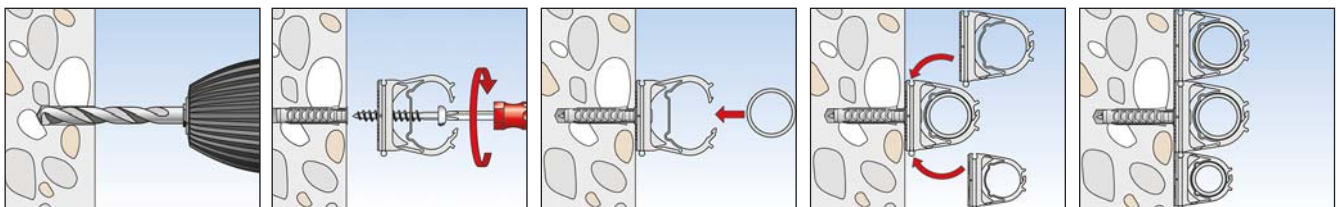

TECHNICAL DATA



Locking clip **SCN**

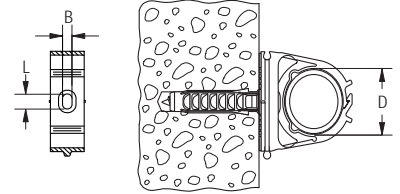

Item	Art.-No.	Pipe to wall distance	Clamping range	Dimension of slot	Sales unit			
		[mm]	D [mm]	B x L [mm]	[pcs]			
SCN 16	501261	11	16	4,5 x 4,5	100			
SCN 20	501262	11	20	4,5 x 6,5	100			
SCN 25	501263	11	25	4,5 x 6,5	50			
SCN 32	501264	13	32	4,5 x 7,5	50			
SCN 40	501265	13	40	4,5 x 7,5	25			
SCN 50	501266	14	50	4,5 x 7,5	25			

The convenient pipe fixing

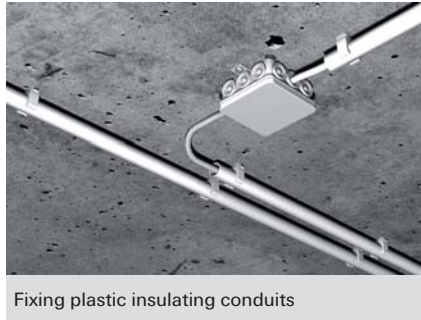

Fixing plastic insulating conduits



Fixing plastic insulating conduits

BUILDING MATERIALS

When using ClipFix SD:

- Concrete
- Solid pumice block
- Solid sand-lime brick
- Natural stone with dense structure
- Solid brick

CHARACTERISTICS



ADVANTAGES

- The pipe clip RC can be used with pre-installed clip fixing SD, with Hammerfix N 6 or in 11 mm C-shaped profile-rails, and thus allows for a flexible and cost-effective installation.
- The 6 mm-long hole allows for the optimal alignment of the pipe fixing and ensures a more user-friendly installation.
- Two additional pipe clips can be added to the sides of a pre-fixed pipe clip. This saves assembly time and materials.
- The long-lasting nylon material is halogen- and silicone-free. It can be used all year round, including during a frost. This ensures a high level of safety.

APPLICATIONS

For fixing of:

- Flexible and rigid plastic insulating pipes

FUNCTIONING

- Plastic insulation pipes are laid into the pipe clip. The pre-tensioning of the pipe clip holds the pipes securely.
- The pipe clip RC is adapted to be fixed with either clip fixing SD or Hammerfix N 6.
- Manually place the ClipFix plus SD directly into the drill hole. No additional screws are needed.
- The Hammerfix N is expanded when the nail is driven in, and holds by friction in the drill hole.
- Temperature resistance once installed from -20 °C to +80 °C.

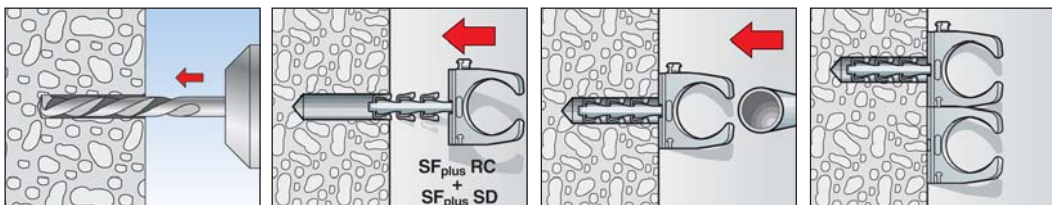

TECHNICAL DATA



Clipfix plus pipe clip **RC**



Pipe clip **RC PG**

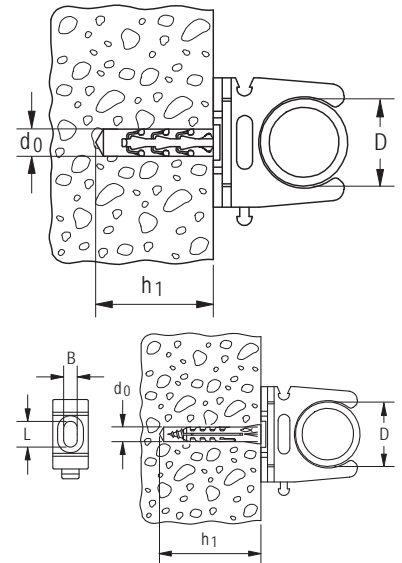

Item	Art.-No.	Drill hole	Min. drill hole depth	Suitable for IEC	Clamping range	Dimension of slot	Sales unit
		d_0 [Ø mm]	h_1 [mm]		D [mm]	B x L [mm]	
SF plus RC IEC 12	048190	6	35	12	12 - 13	6 x 7	100
SF plus RC IEC 16	048191	6	35	16	15 - 16	6 x 8	100
SF plus RC IEC 20	048193	6	35	20	20 - 21	6 x 10	100
SF plus RC IEC 25	048197	6	35	25	24 - 25	6 x 10	50
SF plus RC IEC 32	048198	6	35	32	31 - 32	6 x 10	25
SF plus RC IEC 40	048199	6	35	40	38 - 40	6 x 10	25
RC IEC 12	058194	–	–	12	12 - 13	6 x 7	100
RC IEC 16	058120	–	–	16	15 - 16	6 x 8	100
RC IEC 20	058122	–	–	20	20 - 21	6 x 10	100
RC IEC 25	058198	–	–	25	24 - 25	6 x 10	50
RC IEC 32	058199	–	–	32	31 - 32	6 x 10	40
RC IEC 40	058200	–	–	40	39 - 40	6 x 10	40
RC IEC 50	079194 ¹	–	–	50	50 - 51	6 x 10	20
RC IEC 63	079196 ¹	–	–	63	62 - 64	6 x 10	15

1) Does not include latching catches, therefore cannot be mounted side by side.

The flexible pipe clip for various diameters

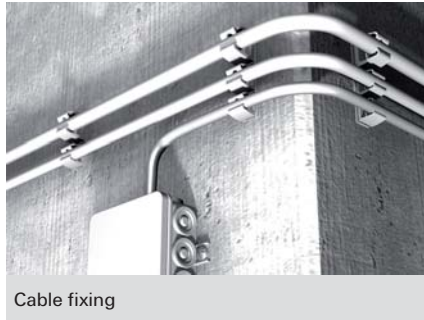

BUILDING MATERIALS

When using Hammerfix N:

- Concrete
- Vertically perforated brick
- Hollow blocks made from lightweight concrete
- Perforated sand-lime brick
- Solid sand-lime brick
- Building brick
- Natural stone
- Aerated concrete
- Solid panel made from gypsum
- Solid brick made from lightweight concrete

CHARACTERISTICS



ADVANTAGES

- The flexible pipe clip socket ensures a secure hold for various cable and pipe diameters, and reduces the number of products required.
- The pipe clip FC can be installed with both N 5 Hammerfixes and 11 mm-C-shaped profile-rails, and thus offers great flexibility.
- Two additional pipe clips can be added to the sides of a pre-fixed clip clamp. This saves assembly time and materials.
- The long-lasting nylon material is halogen-free. It can be used all year round, including during a frost. This ensures a high level of safety.

APPLICATIONS

For fixing of:

- Electric cables
- Flexible and rigid plastic insulating pipes

FUNCTIONALITY

- The clip clamp FC is adapted to suit the fixture using N5 Hammerfixes.
- The Hammerfix N is expanded when the nail is driven in, and holds by friction in the drill hole.
- The cables or pipes are then laid in the clip clamp FC. The pre-tensioning of the clip clamp holds the cables or pipes securely.
- Temperature resistance once installed from -40 °C to +80 °C.

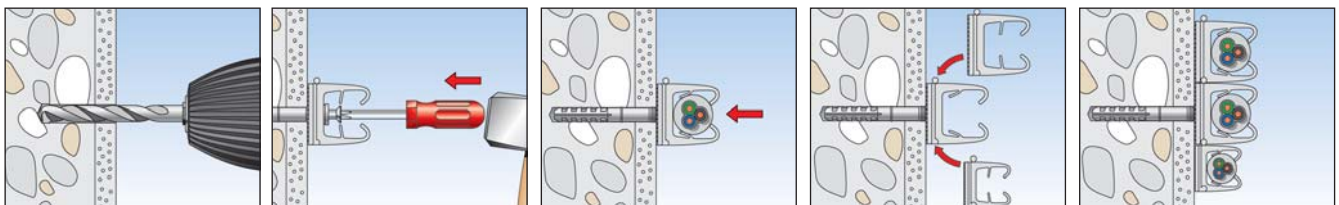

TECHNICAL DATA



Pipe clip **FC**

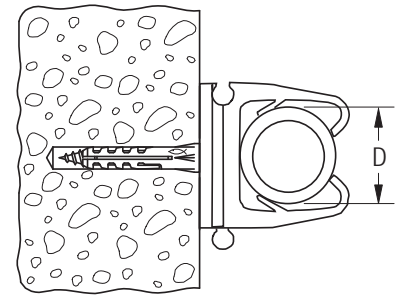

Item	Art.-No.	Clamping range D [mm]	Sales unit [pcs]					
FC 6 - 9 GR	068060	6 - 9	100					
FC 9 - 12 GR	068062	9 - 12	100					
FC 12 - 16 GR	068064	12 - 16	50					
FC 16 - 20 GR	068066	16 - 20	25					

The flexible cable clamp for various diameters

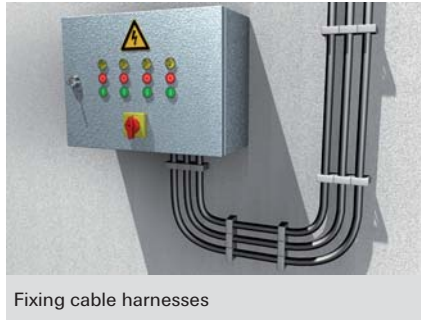

Fixing cable harnesses

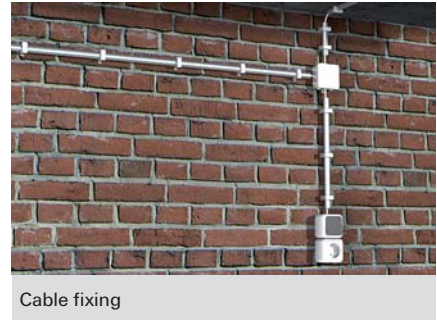

Cable fixing

BUILDING MATERIALS

When using Hammerfix N:

- Concrete
- Vertically perforated brick
- Hollow blocks made from lightweight concrete
- Perforated sand-lime brick
- Solid sand-lime brick
- Building brick
- Natural stone
- Aerated concrete
- Solid panel made from gypsum
- Solid brick made from lightweight concrete

CHARACTERISTICS



ADVANTAGES

- With its elastic spring tabs, the saddle clip SCH can bear different cable diameters. This increases flexibility and reduces the number of products required.
- Additional clips can be added to the sides of a pre-fixed clip. This saves installation time and materials.
- The long-lasting nylon material is halogen- and silicone-free. It can be used all year round, including during a frost. This ensures a high level of safety.

APPLICATIONS

For fixing of:

- Electric cables
- Flexible and rigid plastic insulating pipes

FUNCTIONALITY

- The clamp SCH is adapted to suit the fixture using N 5 Hammerfixes.
- The Hammerfix N is expanded when the nail is driven in, and holds by friction in the drill hole.
- The cables or pipes are then laid in the clamp SCH and fixed by inserting the locking latch.
- The internal tabs adapt to fit various cable or pipe diameters.
- Temperature resistance once installed from -40 °C to +80 °C.

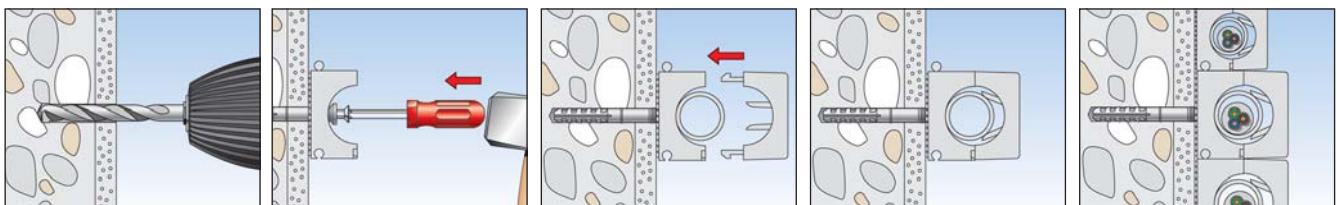



Saddle **SCH**, colour: Nylon transparent

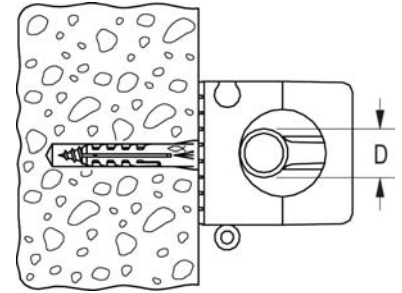

Saddle **SCH**, colour: grey RAL 7035

	Art.-No.		Clamping range D [mm]	Dimension of insulated pipes	Sales unit [pcs]			
	Grey RAL 7035	Nylon trans- parent						
SCH 812	068012	060012	8 - 12	6 x 1 - 8 x 1	100			
SCH 1216	068016	060016	12 - 16	10 x 1 - 12 x 1	50			
SCH 1619	068019	060019	16 - 19	—	50			
SCH 1623	068023	060023	16 - 23	15 x 1 - 18 x 1	50			
SCH 2332	068032	060032	23 - 32	22 x 1 - 22 x 1,5	25			
SCH 3242	—	060042	32 - 42	22 x 1 - 22 x 1,5	25			

Fixing tie for bundling and fixing of cables and pipes to the substrate



Electric cables



Plastic pipes

BUILDING MATERIALS

When using 2-component DUOPO-WER plug:

- Concrete
- Solid brick
- Solid sand-lime brick
- Aerated concrete
- Vertically perforated brick
- Perforated sand-lime brick
- Plasterboard
- Gypsum plasterboard and gypsum fibreboards
- Hollow blocks made from lightweight concrete
- Cavity floor slabs made from bricks and concrete or similar
- Natural stone
- Chipboard
- Solid panel made from gypsum
- Solid brick made from lightweight concrete

CHARACTERISTICS



ADVANTAGES

- The socket of the FF fixing tie is fixed to the substrate with a screw or screw and plug.
- The fixing tie can be used to bundle and fix several cables or pipes.
- Adjustable diameter of the tie loop.
- The socket of the fixing tie can be adjusted through its slotted hole.

APPLICATIONS

- For bundling and fixing of:
- Electric cables
 - Flexible and rigid electric tubes
 - Steel conduits

FUNCTIONING

- The Socket of the fixing tie is fixed with the plug and screw suitable for the substrate.
- Recommended application temperature -20 °C to +60 °C.
- Temperature resistant when installed -40 °C to +80 °C.

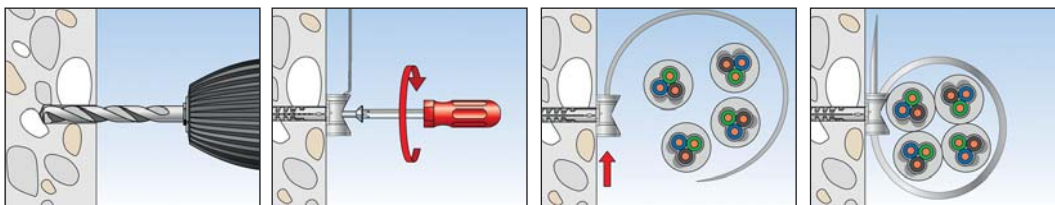

TECHNICAL DATA



Fastening tie FF

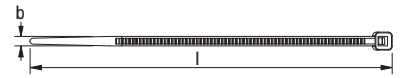

Item	Art.-No.	Length l [mm]	Dimension fixing base [mm]	For cables and pipes from / to $d_{min} - d_{max}$ [Ø mm]	max. screw diameter [mm]	Sales unit [pcs]		
FF 8 - 32	519808	172	25 x 15 x 20	8 - 32	4.5	80		
FF 16 - 63	519809	270	25 x 15 x 20	16 - 63	4.5	40		

The user-friendly clip fixing for pipes and conduits



Cable fixing



Fixing flexible pipes

BUILDING MATERIALS

- Concrete
- Solid pumice block
- Solid sand-lime brick
- Natural stone with dense structure
- Solid brick

CHARACTERISTICS



ADVANTAGES

- The complete element combines anchor, screw and clamp. This saves materials, allows for one-handed installation, and reduces assembly time.
- The slimline geometry of the fixing element only protrudes slightly, thus saving space.
- The three different sizes of each of the cable strap LS, twin clamp ZS and single clamp ES cover a range of cable diameters, thus reducing storage.
- The long-lasting nylon material is flame resistant, halogen- and silicone-free, can be used all year round, including during a frost. This ensures a high level of safety.

APPLICATIONS

- For fixing of:**
- Individual electric cables
 - Cable bundles
 - Flexible pipes
 - Rigid plastic pipes

FUNCTIONING

- The clip fixing is set into the drill hole without the need for any additional screws and fixes the pipe directly to the base material.
- The clamping force of the locking catch allows the ClipFix to hold itself in the drill hole.
- Place the clasp of the cable strap LS into the drill hole so that it is level and the teeth grip.
- Recommended loads (required safety factor considered): cable strap LS up to 6 kg, twin clamp ZS and single clamp ES up to 11 kg.
- Temperature resistance once installed from -20 °C to +80 °C.

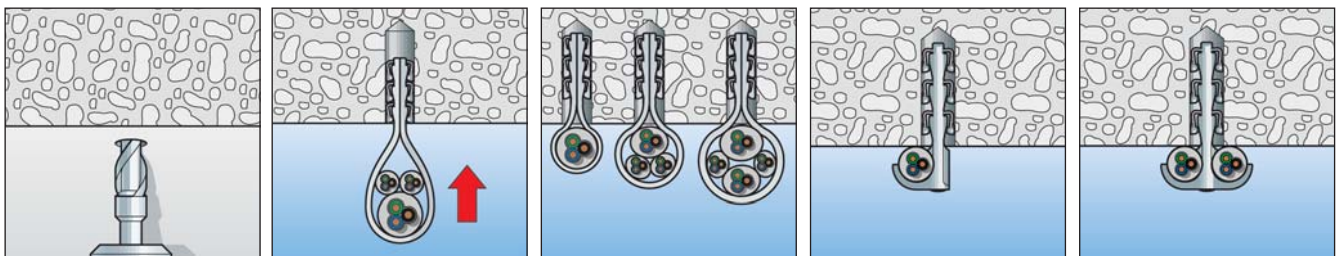

TECHNICAL DATA



Clip fix plus cable strap **SF plus LS**

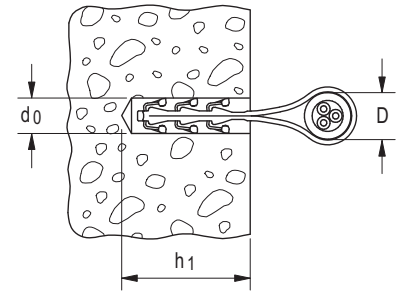

Clip fix plus single clamp **SF plus ES**

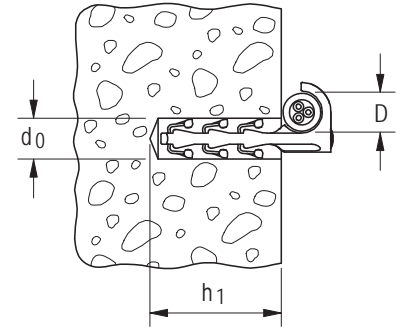

ClipFix plus twin clamp **SF plus ZS**

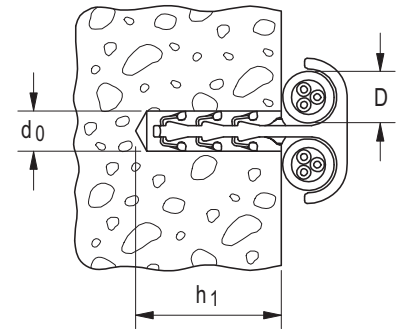

Item	Art.-No.	Drill hole d_0 [Ø mm]	Min. drill hole depth h_1 [mm]	Clamping range D [mm]	Sales unit [pcs]			
SF plus LS 3/13	058155	6	35	3 - 13	100			
SF plus LS 8/28	058156	6	50	8 - 28	100			
SF plus LS 20/40	058157	6	50	20 - 40	100			
SF plus ES 10	048151	6	40	3 - 12	100			
SF plus ES 18	048152	6	40	10 - 25	100			
SF plus ES 28	058183	6	40	15 - 31	100			
SF plus ZS 10	058184	6	35	3 - 12	100			
SF plus ZS 18	048161	6	40	10 - 25	100			
SF plus ZS 28	048162	6	40	15 - 31	75			

The user-friendly clip fixing for cable ducts and cable clasps



Fixing cable ducts

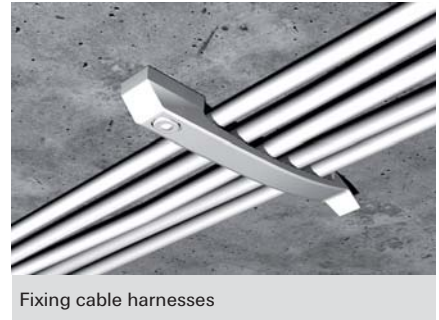

Fixing cable harnesses

BUILDING MATERIALS

- Concrete
- Solid pumice block
- Solid sand-lime brick
- Natural stone with dense structure
- Solid brick

CHARACTERISTICS



ADVANTAGES

- The ClipFix plus SD combines anchor and screw. This saves on materials and makes it easier to affix cable ducts that are difficult to access without the need for additional tools.
- The simple clip fixing reduces installation time.
- The extended shank of the FS plus SD 40 allows bridging of non-bearing plaster layers, as well as the fixing of thicker attachments.
- The long-lasting nylon material is flame resistant, halogen- and silicone-free. It can be used all year round, including during a frost. This ensures a high level of safety.

APPLICATIONS

- For fixing of:**
- Cable channels
 - Cable clasps
 - Installation base cable harness
 - Flat building components

FUNCTIONING

- To fix, manually place the ClipFix plus SD directly into the drill hole. No additional screws are needed.
- The clamping force of the locking catch allows the ClipFix to hold itself in the drill hole.
- Recommended loads (required safety factor considered): clip fixing SD up to 11 kg.
- Temperature resistance once installed from -20 °C to +80 °C.

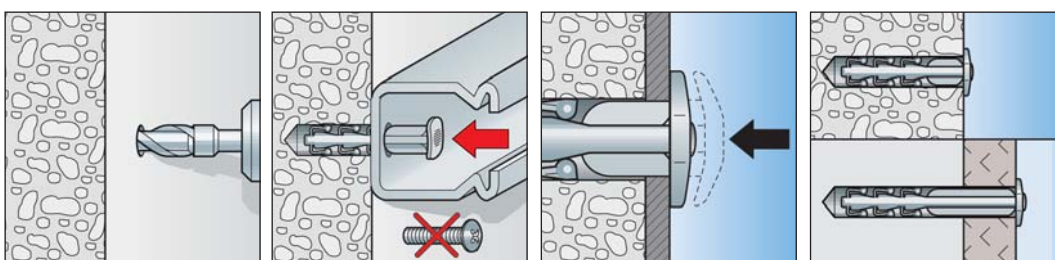

TECHNICAL DATA



fischer ClipFix plus clip fixing **SF plus SD**

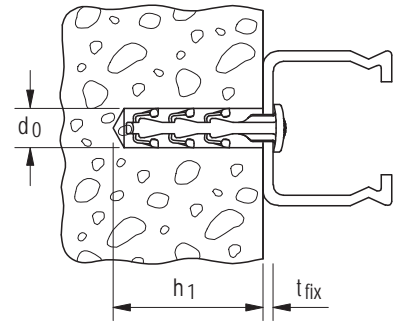

Item	Art.-No.	Drill hole d_0 [Ø mm]	Min. drill hole depth h_1 [mm]	Max. usable length t_{fix} [mm]	Sales unit [pcs]			
SF plus SD 30	058178	6	35	4	200			
SF plus SD 40	058179	6	35	15	100			

The flat cable clasp for space-saving cable fixing

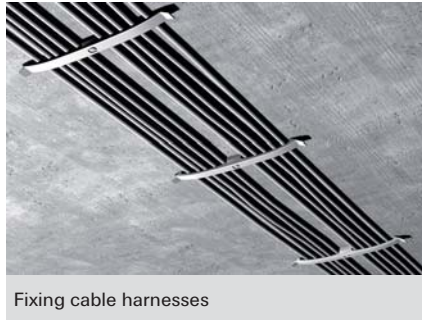

Fixing cable harnesses

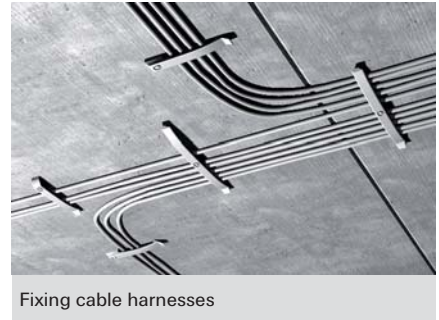

Fixing cable harnesses

BUILDING MATERIALS

When using ClipFix SD:

- Concrete
- Solid pumice block
- Solid sand-lime brick
- Natural stone with dense structure
- Solid brick

CHARACTERISTICS



ADVANTAGES

- The flat design of the KB cable clasp allows for a space-saving cable fixing, and simplifies subsequent cable-laying.
- The combination of cable clasp KB and ClipFix SD allows for one-handed installation, thus enabling a flexible and economic installation.
- The long-lasting nylon material is halogen- and silicone-free. It can be used all year round, including during a frost. This ensures a high level of safety.

APPLICATIONS

- For the fixing of several individual cables

FUNCTIONALITY

- The cable clasp KB is adapted to suit the fixture with clip fixing SD or Hammerfix N6.
- Place the ClipFix plus SD directly into the drill hole by hand. No additional screws are needed.
- The Hammerfix N is expanded when the nail is driven in, and holds by friction in the drill hole.
- After installation, the cables are pulled under the clasp. Additional cables can be easily laid after installation too.
- Temperature resistance once installed from -20 °C to +80 °C.

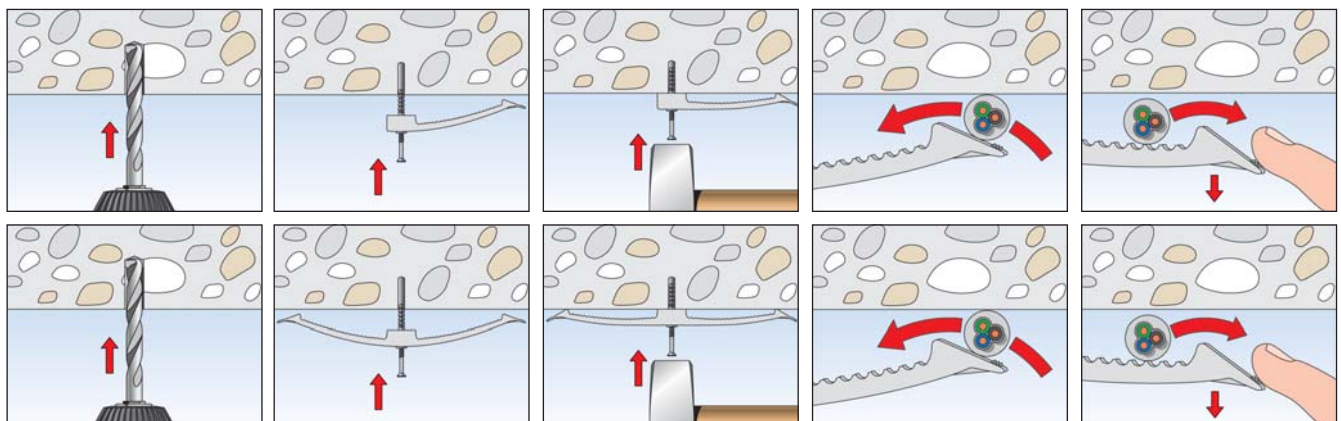

TECHNICAL DATA



Cable clasp with nailplug **KB N 8**



Cable clasp with nailplug **KB N 16**



ClipFix plus cable clasp **SF plus KB 8**



ClipFix plus cable clasp **SF plus KB 16**



Cable clasp **KB 8**



Cable clasp **KB 16**

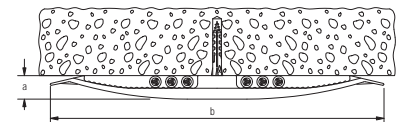
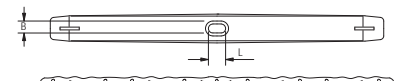
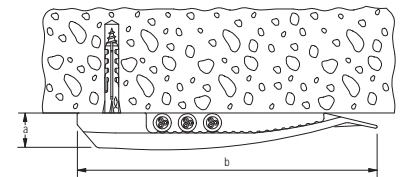
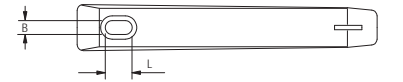
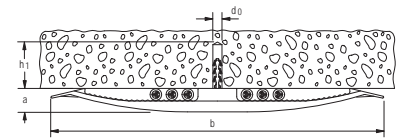
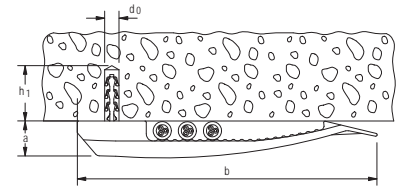
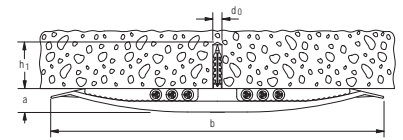
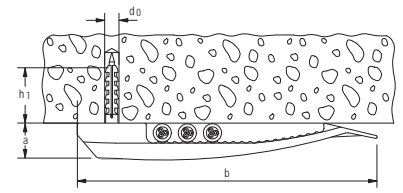

Item	Art.-No.	Drill hole	Min. drill hole depth	Dimensions	Dimension of slot	Max. number of ducts	Sales unit
		d ₀ [Ø mm]	h ₁ [mm]	a x b [mm]	B x L [mm]		
KB N 8	545522	6	35	15 x 133	6 x 10	8 ducts NYM 3 x 1,5	50
KB N 16	545523	6	35	15 x 133	6 x 10	16 ducts NYM 3 x 1,5	25
SF plus KB 8	048171	6	35	15 x 133	6 x 10	8 ducts NYM 3 x 1,5	50
SF plus KB 16	048172	6	35	15 x 230	6 x 10	16 ducts NYM 3 x 1,5	25
KB 8	058135	—	—	15 x 133	6 x 10	8 ducts NYM 3 x 1,5	50
KB 16	058136	—	—	15 x 230	6 x 10	16 ducts NYM 3 x 1,5	50

The adaptable cable harness for fixing cable bundles

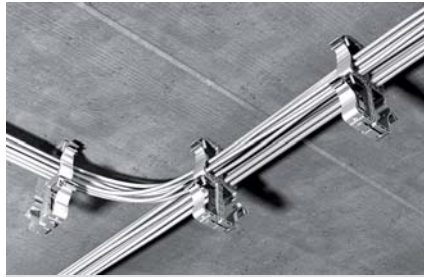

Fixing cable bundles

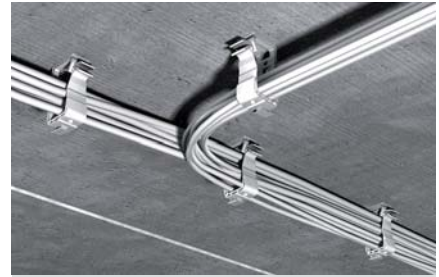

Fixing cable bundles

BUILDING MATERIALS

When using ClipFix SD:

- Concrete
- Solid pumice block
- Solid sand-lime brick
- Natural stone with dense structure
- Solid brick

CHARACTERISTICS



ADVANTAGES

- Simple bundling and economical laying of multiple electric cables.
- The seal of the cable harness SHA makes it easy to lay cables at a later date, thus ensuring high user-friendliness.
- Combining several SHA cable harnesses allows for a cost-effective fixing of cables to just one MS installation base.
- The MS installation base allows for various fixing options, and offers great flexibility for the installation.
- The long-lasting nylon material is halogen- and silicone-free, can be used all year round, including during a frost, and thus ensures a high level of safety.

APPLICATIONS

For fixing of:

- Electric cables, loose and bundled

FUNCTIONING

- Cable bundles can be laid in the cable harness SHA. The seal makes it easy to lay cables at a later date.
- The cable harness SHA can either be affixed with ClipFix plus, installation base MS or with plugs and screws.
- Several SHA cable harnesses can be combined below one another.
- The SHA cable harnesses can also be lined up adjacent to one another with the connection piece SHA KP.
- The maximum installation distance of 80 cm must not be exceeded.
- Temperature resistance once installed from -20 °C to +80 °C.

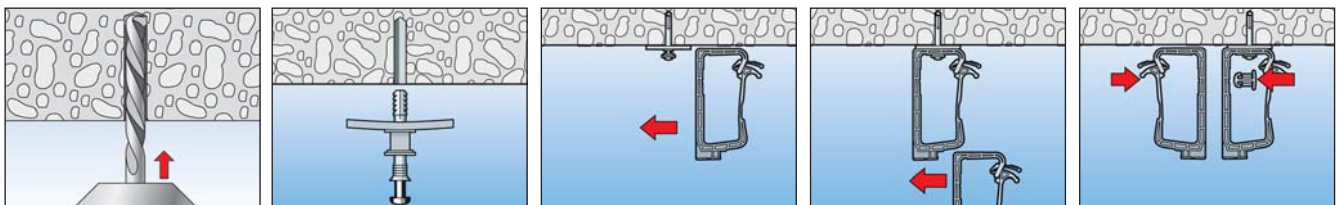

TECHNICAL DATA



Cable harness **SHA**

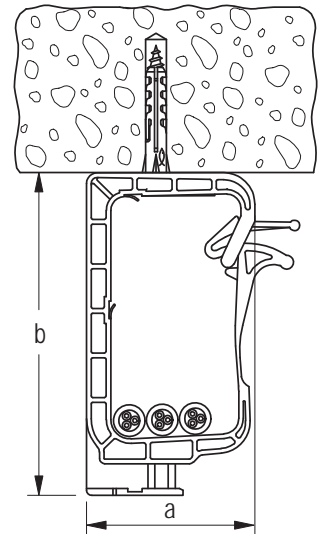

Installation base **SHA MS**

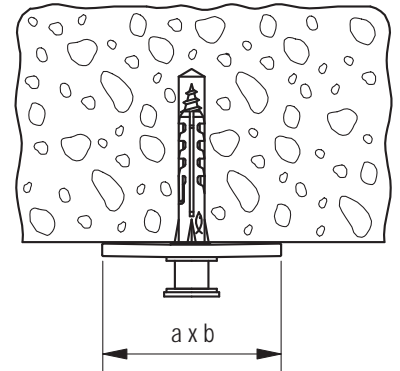

Steckfix plus installation base **SF plus MS**

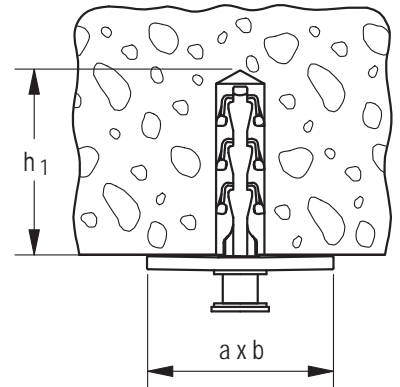

Connection piece **SHA KP**

Item	Art.-No.	Drill hole d_0 [Ø mm]	Min. drill hole depth h_1 [mm]	Dimensions $a \times b$ [mm]	Max. number of ducts	Sales unit [pcs]
SHA 15	058139	–	–	93 x 49	15 ducts NYM 3 x 1,5	50
SHA 30	058140	–	–	128 x 59	30 ducts NYM 3 x 1,5	25
SHA MS	058141	–	–	41 x 27	connection piece	50
SF plus MS	048181	6	35	41 x 27	installation base with clip-plug	50
SHA KP	058142	–	–	–	installation base	50

Metal multi-cable support with high mechanical resistance and approval



Cable fixing to the ceiling



Cable fixing to the wall

ADVANTAGES

- The fischer metal multi cable support SHA M has a high mechanical strength and thus offers a long service life and safety in the event of fire.
- It is approved as a cable-specific variant for circuit integrity maintenance of electric cable systems in accordance with DIN 4102 Part 12.
- This makes it suitable for safe installation above fire protection ceilings.
- Depending on the version, 15, 30 or 70 cables can be fixed.
- The lock, which can be operated without tools, allows easy subsequent cable-laying and thus ensures a high degree of ease of installation.
- The multi cable support is variably suitable for wall and ceiling installation.
- Halogen-free and without fire load.

APPLICATIONS

- Fixing of cables with circuit integrity maintenance.
- Installation of electrical cables above fire protection ceilings.

FUNCTIONING

- The multi cable support is fixed to walls or ceilings with plugs and screws or metal anchors suitable for the substrate and application.

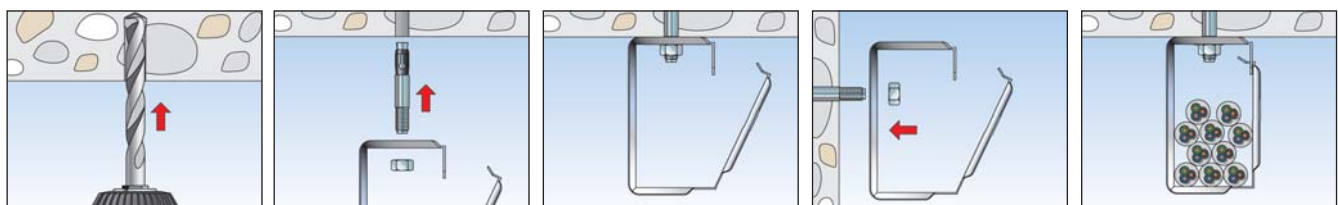

TECHNICAL DATA



Multi cable support metal **SHA M**

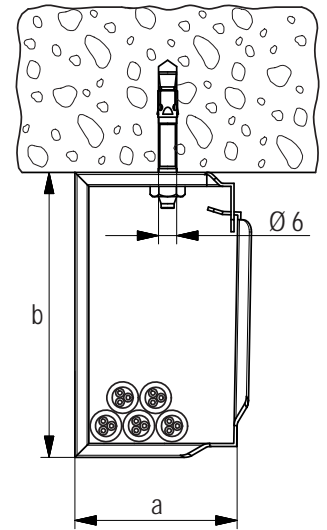

Item	Art.-No.	Mounting pipe Ø [mm]	Dimension in [mm]	Max. number of ducts	Sales unit [pcs]
SHA M 15	544933	6	66,7 x 41,9 x 30,6	15 ducts NYM 3 x 1,5	50
SHA M 30	544934	6	92,8 x 58,1 x 33,6	30 ducts NYM 3 x 1,5	25
SHA M 70	544935	6	126,0 x 104,0 x 80,0	70 ducts NYM 3 x 1,5	10

The quick tool-free cable fixing in wall slots



Cable fixing in wall slots > 30 mm



Cable fixing in wall slots < 55 mm

BUILDING MATERIALS

- Concrete
- Masonry

ADVANTAGES

- With the fischer FWSC wall slot clip, cables can be fixed quickly and without tools in wall slots 20 to 60 mm wide.
- This reduces installation time by up to 50%.
- The high expansion power of the wall slot clip guarantees a reliable fixing of the cables.
- Damage to the cables can be excluded due to the expansion principle.
- Thanks to its neutral colour, the wall slot clip does not shine through the plaster.
- The wall slot clip is made of halogen-free material.

APPLICATIONS

- Fixing of cables in wall slots of 20 - 60 mm width.

FUNCTIONING

- The cables to be fastened are inserted into the wall slot.
- By pressing together the wall slot clip is compressed and tensed to be ready for installation in the wall slot.
- The wall slot clip can be compressed in length or width as required and thus used for wall slots with a width of 20 to 60 mm.

TECHNICAL DATA



Wall slot clip FWSC

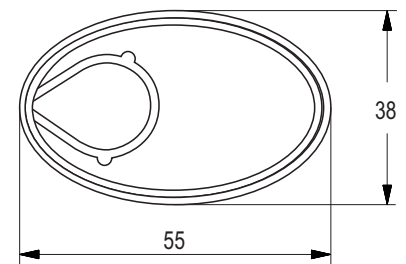

Item	Art.-No.	Max. slot width [mm]	Dimension in [mm]	Sales unit [pcs]			
FWSC 20 - 60	545792	60	38 x 60 x 4	50			

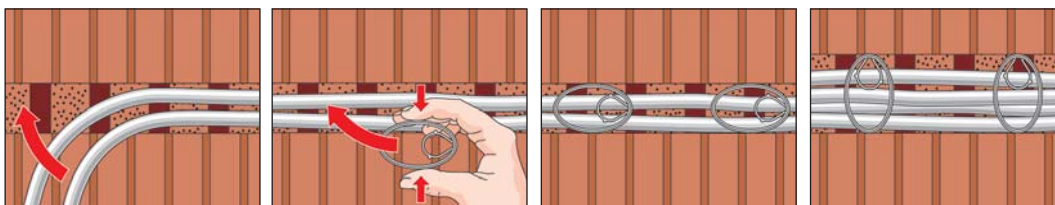

The secure cable fixing in wall slots



Cable fixing



Cable fixing in slits

BUILDING MATERIALS

- Vertically perforated brick
- Pumice
- Lightweight aggregate concrete
- Aerated concrete
- Hardboard
- Wood
- Chipboard
- Plywood
- Solid panel made from gypsum

ADVANTAGES

- The nail disc NSB allows for use in two slot widths.
- The vaulted structure of the nail disc ensures an optimal contact pressure and, as such, for a secure hold.
- The flat nail disc only protrudes slightly, and can thus be easily plastered over.
- The nail disc NSB is made from high-strength polypropylene. The nail is made from hardened, galvanised steel. The tried and tested material combination for in-wall installation.

APPLICATIONS

- For fixing cables in wall slots

FUNCTIONALITY

- Remove cable.
- Align the nail disc with either dimensions 27 mm or 34 mm, depending on the slot width, and hit the nail in with a hammer.
- The cables are fixed in the wall slots by the curved washer.

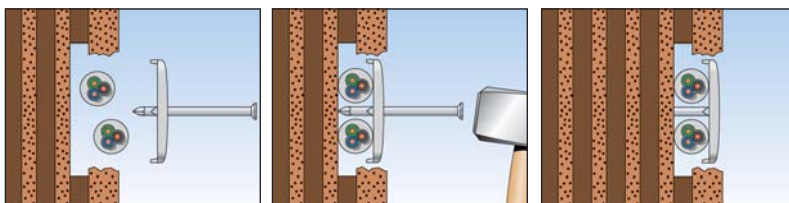

TECHNICAL DATA

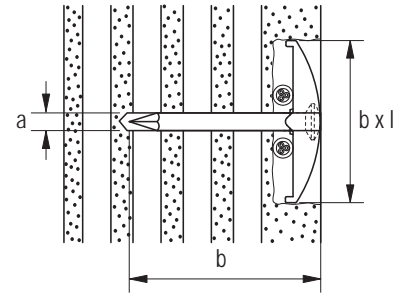
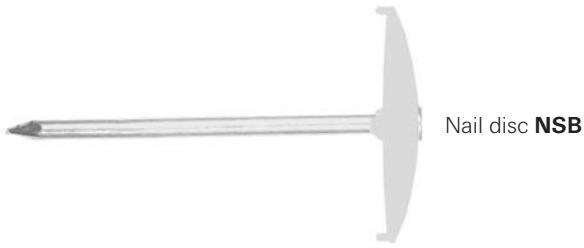

Item	Art.-No.	Dimension of nail	Dimension of disc	Sales unit				
		a x b [mm]	b x l [mm]	[pcs]				
NSB 2/40	048308	2 x 40	27 x 34	200				
NSB 2/50	048309	2 x 50	27 x 34	150				
NSB 2/60	048310	2 x 60	27 x 34	100				
NSB 3/40	048311	3 x 40	27 x 34	150				
NSB 3/50	048312	3 x 50	27 x 34	150				
NSB 3/60	048313	3 x 60	27 x 34	100				

The fast fixing for electric cables



BUILDING MATERIALS

- Hardboard
- Wood
- Aerated concrete
- Chipboard
- Plywood
- Solid gypsum panels and other plastered substrates

ADVANTAGES

- The nail clip features a pre-assembled zinc-plated nail, allowing for a fast fixing, thus reducing assembly time.
- The small space required for fixing simplifies installation in narrow spaces.
- The nail clip MNS covers cable diameters from 4 mm to 14 mm with just 3 sizes.

APPLICATIONS

- To fix single electric cables with varying diameters

FUNCTIONING

- Position the nail clip with the laid cable. Hammer in the pre-assembled nail with a hammer.

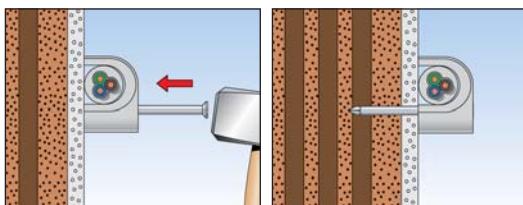

TECHNICAL DATA



Nail clip **NS**

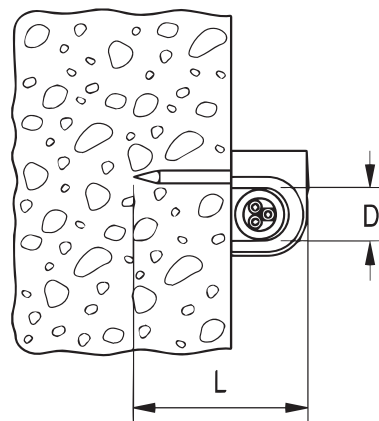

Nail clip **MNS**

Electrical fixings 8

Item	Art.-No.	For cable	Clamping range	Length of nail	Sales unit			
		[Ø mm]	D [mm]	L [mm]	[pcs]			
NS 7	058173	7	7	25	100			
NS 8	058174	8	8	25	100			
NS 9	058175	9	9	25	100			
NS 10	058176	10	10	30	100			
NS 12	058177	12	12	35	100			
MNS 4-7	094673	–	4 - 7	25	100			
MNS 7-11	094674	–	7 - 11	25	100			
MNS 10-14	094675	–	10 - 14	30	100			

The installation-friendly metal spacing disc for cables and pipes

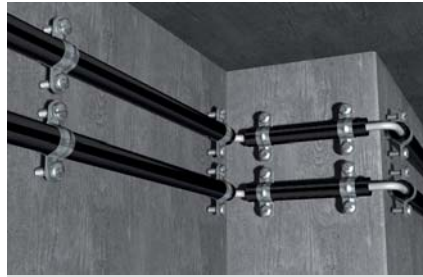

Fixing steel armoured conduits



Fixing conduits

BUILDING MATERIALS

When using nail anchor FNA II:

- Concrete
- Solid sand-lime brick
- Natural stone with dense structure
- Pre-stressed concrete hollow slabs

When using Hammerfix N:

- Concrete
- Solid sand-lime brick
- Building brick
- Natural stone
- Solid brick made from lightweight concrete

ADVANTAGES

- The fast-locking latch ensures easy opening and closing without completely removing the screw, and allows for a simple and fast installation.
- The pre-fitted combination screw with conventional slotted or recessed screw head allows for the use of different screwdrivers, thus allowing for a simple installation.

APPLICATIONS

For fixing of:

- Steel conduits
- Electric cables
- Copper and metal pipes

FUNCTIONING

- The spacer clamp AM with M6 thread can either be affixed with fischer nail anchor FNA II 6x30 M6x43, stud screw STST 6x60 and STST 6x80 or with Hammerfix N 6x40/10 M6.

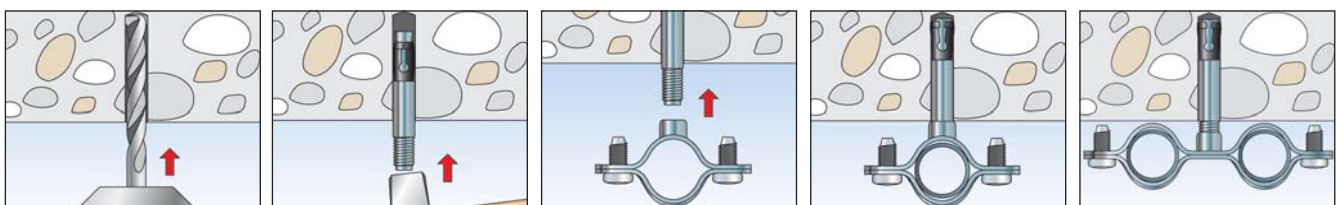

TECHNICAL DATA



Metal two-piece pipe clamp **AM**

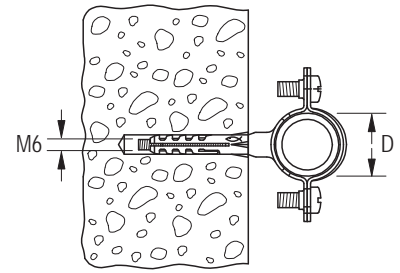

Item	Art.-No.	Dimension IEC	Clamping range D [mm]	Sales unit [pcs]				
AM 8	060185	–	8 - 10	50				
AM 10	060186	–	10 - 11	50				
AM 12	060187	12	12 - 13	50				
AM 14	060188	–	14 - 15	50				
AM 16	060189	16	15 - 17	50				
AM 18	060190	–	18 - 19	50				
AM 20	060191	20	20 - 21	50				
AM 22	060192	–	22 - 23	50				
AM 24	060193	–	24 - 25	50				
AM 26	060194	25	26 - 27	50				
AM 28	060195	–	28 - 29	50				
AM 30	060196	–	30 - 31	50				
AM 32	060209	32	32 - 33	25				
AM 34	060210	–	34 - 35	25				
AM 37	060211	37	37 - 39	20				
AM 40	090849	40	40 - 42	15				
AM 50	090850	50	50 - 52	10				
AM 63	090851	63	63 - 65	10				

TECHNICAL DATA



Metal two-piece pipe clamp **AMD**

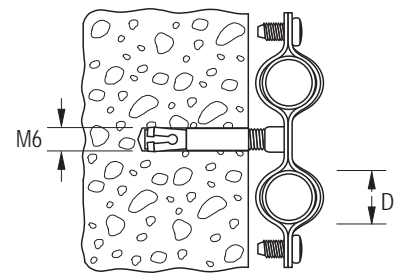

Item	Art.-No.	Clamping range D [mm]	Sales unit [pcs]					
AMD 10 - 12	545772	10 - 12	25					
AMD 14 - 16	545773	14 - 16	25					
AMD 17 - 19	545774	17 - 19	25					
AMD 20 - 23	545775	20 - 23	25					
AMD 24 - 27	545776	24 - 27	25					

The flat metal clip for cables and pipes

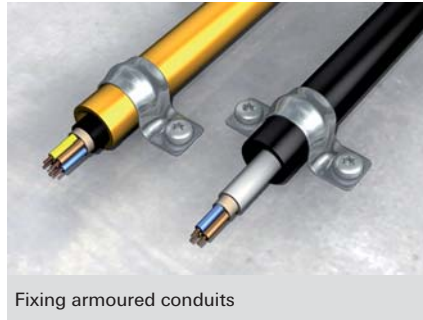

Fixing armoured conduits



Fixing armoured conduits

BUILDING MATERIALS

When using impact nail ED:

- Concrete

ADVANTAGES

- The open conduit clip BSM is ideal for the post-installation fixing of conduits.
- The conduit clip allows for a direct fixing with impact nails and is, therefore, quick and easy to install.
- Two conduits or pipes can be fixed with just one fixing point with the twin clamp BSMZ.

APPLICATIONS

For fixing of:

- Electrical conduits
- Flexible and rigid plastic insulating pipes
- Steel conduits

FUNCTIONING

- Depending on your requirements, use a conduit clip with 1 or 2 fixing points, or a twin clamp.
- The conduits or pipes are laid in the conduit clip. Assembling the clip fixes the conduits / pipes.
- Our recommendation for fixtures on concrete (not older than 6 months): Impact nail.

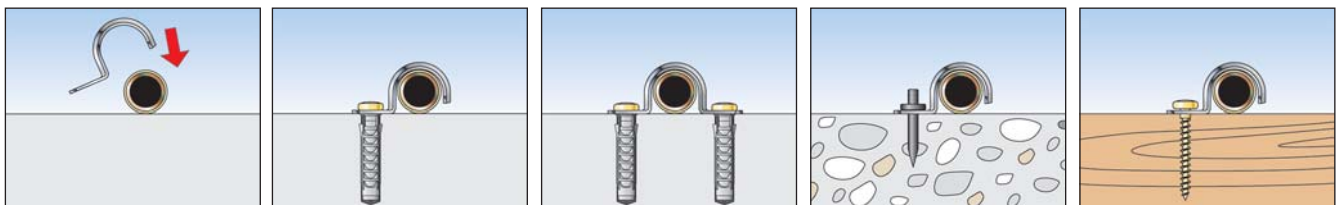

TECHNICAL DATA



Conduit clip **BSM**



Conduit clip **BSM-D**



Conduit clip **BSM-Z**

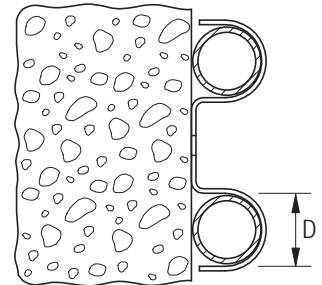
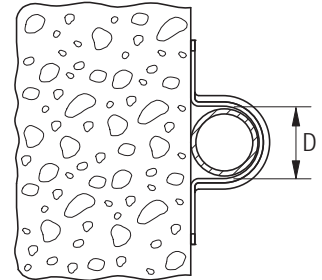
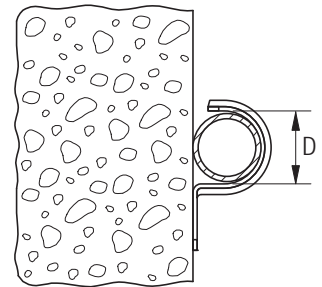

Item	Art.-No.			Dimension IEC	Clamping range D [mm]	Sales unit [pcs]	
	BSM	BSM-D	BSM-Z				
6	015014	—	—	—	6	100	
8	015015	—	—	—	8	100	
10	015016	—	—	—	10	100	
10	—	015068	—	—	10	50	
12	015017	015069	—	—	12	50	
14	015018	015070	—	—	14	50	
15	015093	—	—	15	15	50	
16	060149	060169	—	16	16	50	
18	060150	060170	—	—	18	50	
20	060151	060171	079535	20	20	50	
22	060152	060172	—	—	22	50	
24	060153	—	079536	—	24	50	
25	090839	090844	—	25	25	50	
26	096958	015076	—	—	26	50	
28	—	060175	—	—	28	25	
28	060155	—	079537	—	28	50	
30	015019	—	—	—	30	50	
32	090840	—	—	32	32	50	
32	—	090845	—	32	32	25	
37	060158	060178	—	—	37	25	
40	090841	090846	—	40	40	25	
42	—	015081	—	—	42	20	
42	015021	—	—	—	42	25	
47	—	015082	—	—	47	20	
50	090842	—	—	50	50	20	
50	—	090847	—	50	50	15	
63	—	090848	—	63	63	10	
63	090843	—	—	63	63	15	

Textile web strapping GWB for cost-effective, easy pipe fixings



Flexible and rigid plastic insulation pipes

ADVANTAGES/BENEFITS

- Pipe fastening using textile tape allows cheap and simple installation.
- The textile tape roll allows the correct tape length to be chosen to suit the diameter in question.
- Hangings with textile tape are a fast solution for temporary fixings.

APPLICATIONS

- Tear-proof textile tape for simple and load-bearing installation
- Fixing to concrete using the fischer impact nail ED

PROPERTIES

- **Material:** polypropylene

TECHNICAL DATA

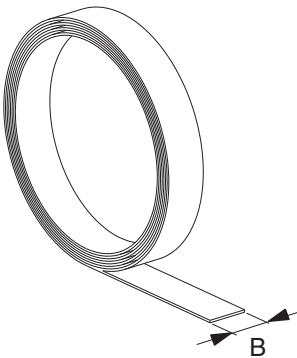

Item	Art.-No.	Total length [mm]	Width [mm]	Thickness S [mm]	Sales unit [pcs]
GWB	020959	10000	15	1.1	10

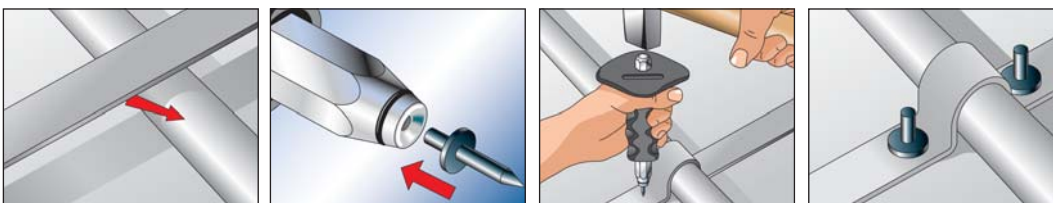

Perforated steel banding LBV / LBK for the fast fixing of pipelines



Plastic pipes

ADVANTAGES/BENEFITS

- The perforated tape's material thicknesses and plastic covering allows the tapes to be easily cut to size using metal shears.
- The perforated tape's hole geometry enables concrete fixing using the fischer impact nail ED.

APPLICATIONS

- Steel tape with stamped holes for simple installation; available zinc-plated LBV or plastic-covered LKB
- The fischer nail anchor FNA II is suitable for ceiling fixing in concrete
- Use fischer thread hanger RAH for fastening to threaded rods

PROPERTIES

- **Material:** steel DX51D+Z (material no. 1.0226) acc. to DIN EN 10327
- **Zinc plating:** electro zinc-plated, min. 7 µm
- **Protective coating LBK:** PE

TECHNICAL DATA

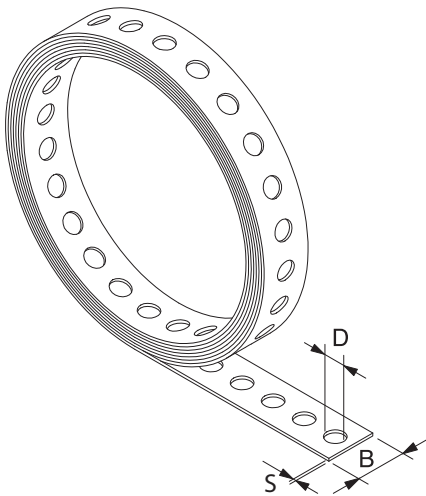

Item	Art.-No.	Total length	Width B	Thickness	Eye-Ø	Sales unit
		l [mm]	B [mm]	S [mm]	D [mm]	[pcs]
LBV 12	079549	10000	12	0.75	5	10
LBV 17	079550	10000	17	0.75	6.5	10
LBV 25	079551	10000	25	0.88	8.5	8
LBK 14	079553	10000	14	2.6	5	10
LBK 19	079554	10000	19	2.4	6.5	8
LBK 27	079555	10000	27	2.4	8.5	5

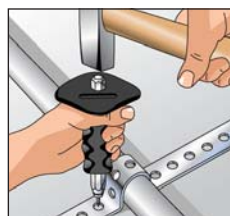
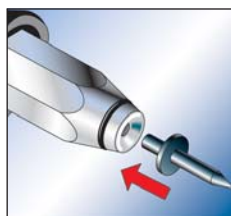
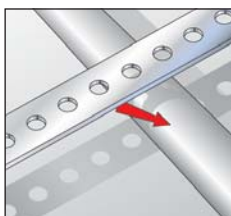

Fixing in concrete without pre-drilling



Fixing armoured conduits



Fixing perforated tapes

BUILDING MATERIALS

- Fresh concrete (not older than 6 months)

ADVANTAGES

- The stable impact nail ED can be set in concrete with the impact nail setting tool SZE without pre-drilling. This allows for a fast installation.
- The setting tool SZE impact protection provides the best protection for your hand, thus ensuring a safe installation.

APPLICATIONS

For fixing of:

- Conduit clips such as BSM, BSMD, BSMZ
- Perforated band such as LBK, LBV

FUNCTIONALITY

- The impact nail ED is set in the setting tool SZE.
- The bracket in the setting tool holds the nail securely in place during the installation procedure.
- Pre-positioning of the element to be fixed.
- The nail can be hammered through the fixing element directly into the concrete (not older than 6 months).

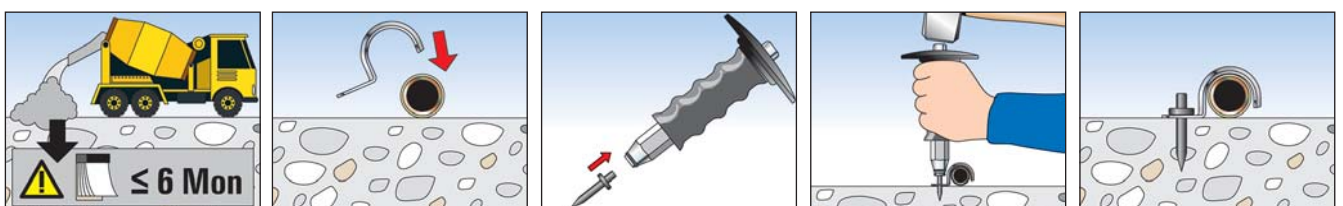

TECHNICAL DATA



Impact nail ED

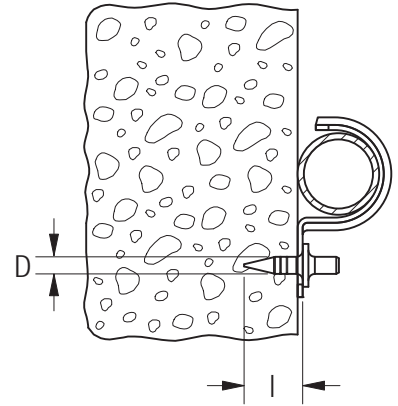

Item	Art.-No.	Length	Diameter	Sales unit				
		l [mm]	d [mm]	[pcs]				
ED 15	048212	15	4.0	200				
ED 18	079815	18	4.0	200				
ED 22	014570	22	4.0	200				

TECHNICAL DATA



Impact nail setting tool SZE

Toolset for SZE

Item	Art.-No.	Sales unit						
		[pcs]						
SZE	079820	1						
Toolset for SZE	043365	4						

For the simple bundling of cables and pipes



Bundling electric cables

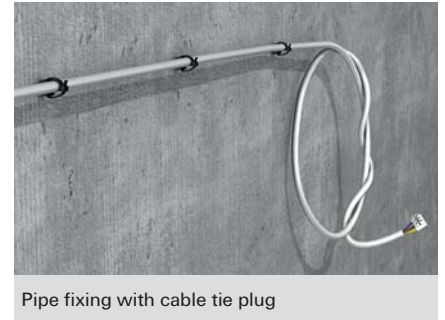

Pipe fixing with cable tie plug

CHARACTERISTICS



ADVANTAGES

- The long-lasting nylon material is halogen- and silicone-free.
- The cable tie UBN (black) is made from UV-stabilised material.

APPLICATIONS

- For bundling of:**
- Electric cables
 - Flexible and rigid plastic insulating pipes
 - Steel conduits

FUNCTIONING

- Lie the cable tie around the object to be fixed, and pull the band through the head of the cable tie. The cable tie can no longer be opened due to the latching of the tab in the teeth.
- Temperature resistance once installed from -10 °C to +85 °C.
- Recommended installation temperature from -10 °C to +85 °C.

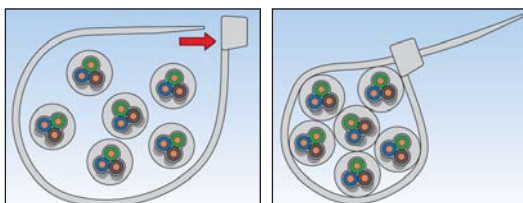

TECHNICAL DATA

 Cable tie **BN**, colour: transparent

 Cable tie **UBN**, colour: black

 Cable tie **GBN**, colour: green

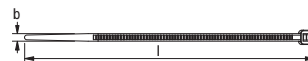

Item	Art.-No.			Dimensions [mm]	Sales unit [pcs]	Outer carton [pcs]	
	Colour: black	Colour: transparent	Colour: green				
BN/UBN/GBN 2,5 x 100	087488	087478	543924	2,5 x 100	100	20000	
BN/UBN 2,5 x 120	087489	087479	—	2,5 x 120	100	15000	
GBN 2,5 x 150	—	—	543925	2,5 x 150	100	20000	
BN/UBN/GBN 2,5 x 200	087490	087480	543926	2,5 x 200	100	10000	
BN/UBN 2,5 x 160	069363	037489	—	2,5 x 160	100	20000	
BN/UBN/GBN 3,6 x 150	087491	087481	543927	3,6 x 150	100	10000	
BN/UBN 3,6 x 200	037573	019802	—	3,6 x 200	100	10000	
BN/UBN 3,6 x 300	069364	037490	—	3,6 x 300	100	7500	
BN/UBN 4,6 x 160	069365	037501	—	4,6 x 160	100	10000	
BN/UBN 4,6 x 190	069366	037581	—	4,6 x 190	100	10000	
BN/UBN/GBN 4,6 x 200	087494	087484	543928	4,6 x 200	100	7500	
BN/UBN 4,8 x 250	069367	—	—	4,8 x 250	100	5000	
BN/UBN 4,8 x 250	—	037582	—	4,8 x 250	100	5000	
BN/UBN/GBN 4,8 x 280	087495	087485	543929	4,8 x 280	100	5000	
BN/UBN 4,8 x 350	069368	037653	—	4,8 x 350	100	5000	
BN/UBN 4,8 x 370	069369	037583	—	4,8 x 370	100	5000	
BN/UBN 4,8 x 430	069370	037708	—	4,8 x 430	100	5000	
BN/UBN 7,6 x 200	069372	037945	—	7,6 x 200	100	4500	
BN/UBN 7,8 x 300	069373	037949	—	7,6 x 300	100	2500	
BN/UBN 7,6 x 350	087497	087487	—	7,6 x 350	100	2500	
BN/UBN 7,6 x 450	069374	037996	—	7,6 x 450	100	2500	
BN/UBN 7,6 x 550	069375	037997	—	7,6 x 550	100	2000	
BN/UBN 8,8 x 760	069376	037998	—	8,8 x 760	100	1000	
BN/UBN 8,8 x 810	069377	038000	—	8,8 x 810	100	1000	
BN/UBN 8,8 x 1168	069379	038002	—	8,8 x 1168	100	500	

The universal fixing point for cable ties

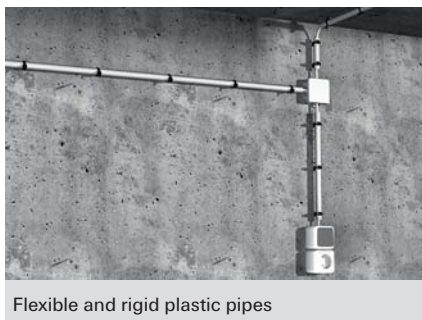
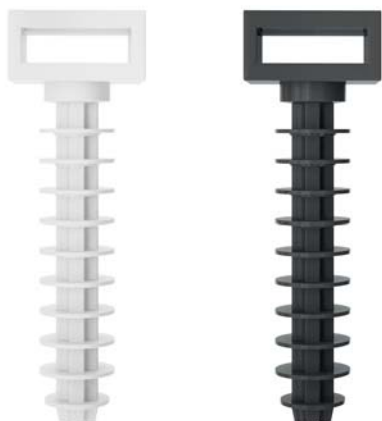

Flexible and rigid plastic pipes

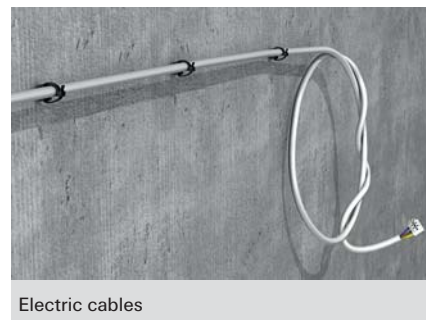

Electric cables

BUILDING MATERIALS

- Concrete
- Solid brick
- Solid sand-lime brick

ADVANTAGES

- The FCTP cable tie plug combines the function of a plug and an eyelet to which cable ties up to 9.5 mm width can be attached (e.g. fischer BN or UBN).
- It offers a universal fixing point to which various cables and pipes can be attached.
- Installation is simple and time-saving by driving the plug into the drill hole.
- The lamellas of the plug ensure a secure hold in the building material and thus fix the cable tie in the intended position.

APPLICATIONS

- Universal fixing point for fixing of cables and pipes using cable ties

FUNCTIONING

- The cable tie plug can be hammer set.
- A cable tie is inserted through the eyelet and the object to be fastened is fixed in the intended position.
- The eyelet with a width of 9.5 mm and a height of 3 mm is suitable for all fischer cable ties.

TECHNICAL DATA

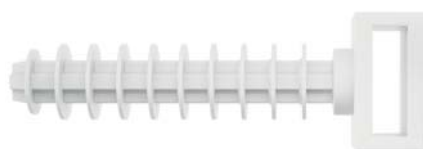

Cable tie plug FCTP

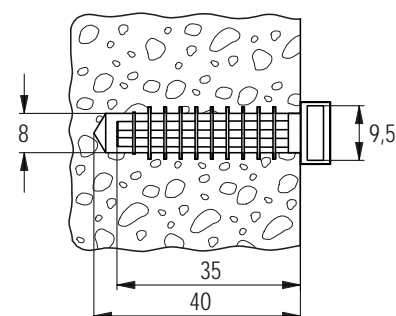

Item	Art.-No.	Drill diameter d_0 [mm]	Min. drill hole depth h_1 [mm]	Anchorage depth h_{ef} [mm]	Total length l [mm]	Sales unit [pcs]		
FCTP-W	545786	8	40	35	45	100		
FCTP-B	545787	8	40	35	45	100		

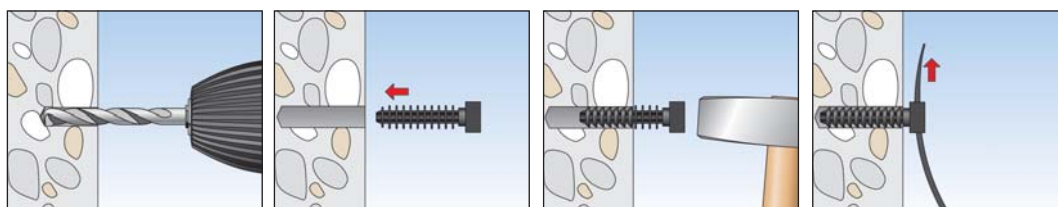

Infinitely variable fixing of wire suspensions



ADVANTAGES

- The simple system guarantees ease of use.
- The Wireclip's simple closing mechanism means that no tools are needed. This allows for a cost-effective installation.
- The reclosable Wireclips make it possible to adjust the length at any time. This guarantees the greatest flexibility.

APPLICATIONS

For suspension of:

- Lighting strips
- Cable trays
- Ventilation ducts
- Pipes
- Signs
- Chilled ceilings

FUNCTIONALITY

- Loops are formed from the wire, which can be threaded through the wireclip. This allows objects to be hung. The wireclips can be adjusted at any time.
- The FNA II 6x25 OE is suitable for fixing the wire.

Note:

- Do not apply paint or any other coating.
- Do not apply lubricant.
- Do not use for lifting loads.
- Remove damaged wire ends using the wire cutter WIZ prior to introducing wires into the wire clip.

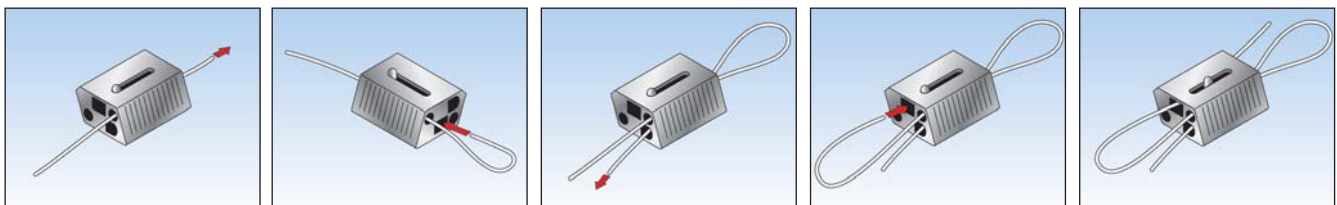

TECHNICAL DATA



WIC 2

WIC 3

WIC 4

Item	Art.-No.	Wire-Ø [mm]	Sales unit [pcs]					
WIC 2 VE20	044559	2 - 2,5	20					
WIC 3 VE20	044561	2,5 - 3,5	20					
WIC 2 VE100	044560	2 - 2,5	100					
WIC 4 VE50	044564	3 - 4	50					

TECHNICAL DATA



WIS cable set with eyelet



Wire cutter WIZ

Item	Art.-No.	Cable length [m]	Wire-Ø [mm]	Sales unit [pcs]				
WIS 2/1	045956	1	2	10				
WIS 2/2	045957	2	2	10				
WIS 2/3	045958	3	2	10				
WIS 2/5	045959	5	2	10				
WIS 2/10	045960	10	2	10				
WI Ø 2 mm	044565 ¹⁾	200	2	1				
WIZ	044721	–	–	1				

¹⁾ on a roll

LOADS

Wireclip

Highest recommended loads¹⁾ per Wireclip

Type	Diameter of wire cable [mm]	Recommended tensile load [kN]
WIS complete system	2,0	0,5
WIC 2 ²⁾	2,0	0,6
WIC 2 ²⁾	2,5	1,0
WIC 3 ²⁾	3,0	1,2
WIC 4 ²⁾	4,0	2,3



¹⁾ Required safety factors are considered.

²⁾ Only in combination with fischer wire cable.





9 Sanitary fixings

		Page
Sanitary fixings for board materials		456
Ceramic fixings		458
Wash basin and urinal fixings		460

Complete fixing sets for wash basins and urinals in board building materials and plumbing walls



Urinals



Wash basins

BUILDING MATERIALS

- Gypsum plasterboard and gypsum fibreboards
- Chipboard

ADVANTAGES

- With their special geometries, KM and WDP are the specialists for fixings in plumbing and hollow walls.
- The wide transition beams of the KM and the large base plate of the WDP ensure a good load distribution, thus allowing for a high load-bearing capacity.

APPLICATIONS

- Wash basins
- Urinals

FUNCTIONING

- KM is suitable for push-through installation.
- When placed in the drill hole, the wide transition beam of the KM independently swings open behind the board.
- WDP is set into the plumbing walls during wall installation.

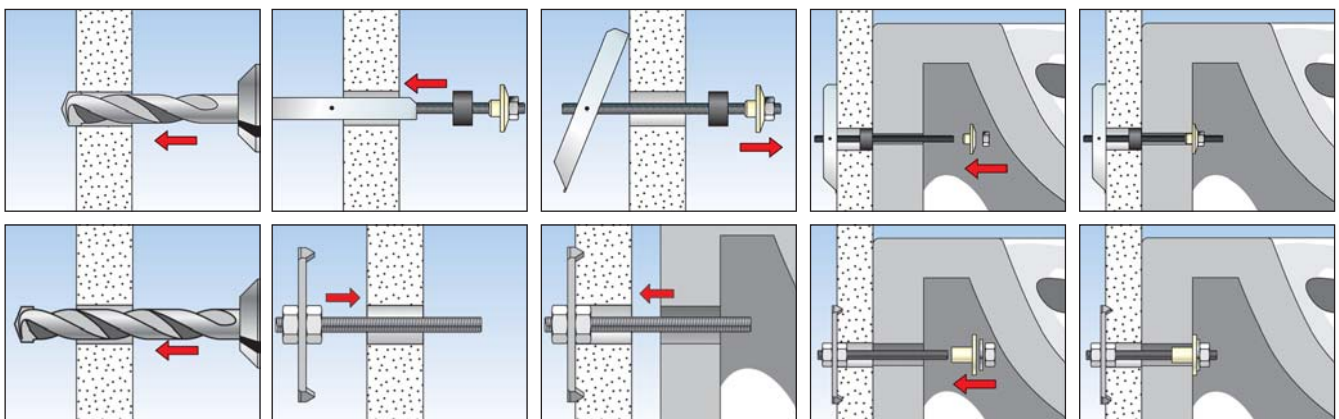

TECHNICAL DATA



Wash basin and urinal fixing **WDP**

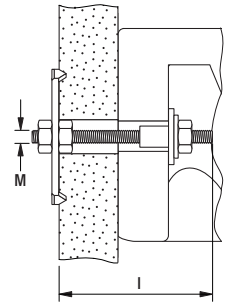

Item	Art.-No.	Contents per plastic bag	Sales unit
		[pcs]	[pcs]
WDP 10 x 170	014320	2 Threaded rods M10 x 170 with base plate 60x60x3, 2 flanged bushes BDH M10, 2 hexagon nuts M10 zinc-plated	10

TECHNICAL DATA

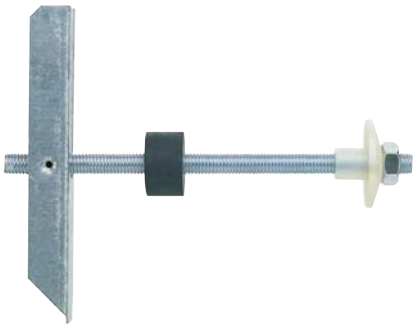

Gravity toggle **KM 10**

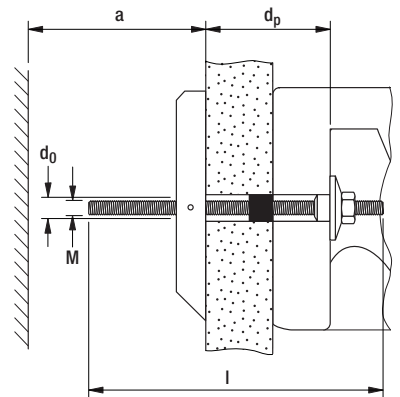

Item	Art.-No.	Drill hole diameter	Anchor length	Min. cavity depth	Max. panel thickness	Screw	Sales unit
		d_0 [mm]	l [mm]	a [mm]	d_p [mm]	$d_s \times l_s$ [mm]	[pcs]
KM 10	050326	30	180	140	90	M 10 x 180	25

Complete fixing sets for free-standing toilets and bidets



BUILDING MATERIALS

- Concrete
- Solid sand-lime brick
- Natural stone with dense structure
- Solid brick made from lightweight concrete
- Solid brick

CHARACTERISTICS



ADVANTAGES

- Complete fixing sets including brass screws allow for quick and easy installation.
- A pronounced rim prevents contact between the screw and ceramics, thus ensuring nothing gets damaged during fixing.
- The WB5N's assembly bracket with pre-drilled rows of holes allows for a flexible fixing with two directions.
- The WCN is also suitable for fixing ceramic shelves and mirrors, and can thus be used for a wide range of applications.

APPLICATIONS

- Free-standing toilets
- Bidets
- Ceramic shelves
- Mirrors

FUNCTIONING

- S 8 RD is suitable for push-through installation.
- WCN and S 8 D are suitable for both pre-positioned and push-through installation.
- The WB5N's assembly bracket is flexibly positioned on the base using the long hole. The ceramics are then fixed to the bracket via the rows of holes. These counterbalance any height differences in the ceramic assembly holes.

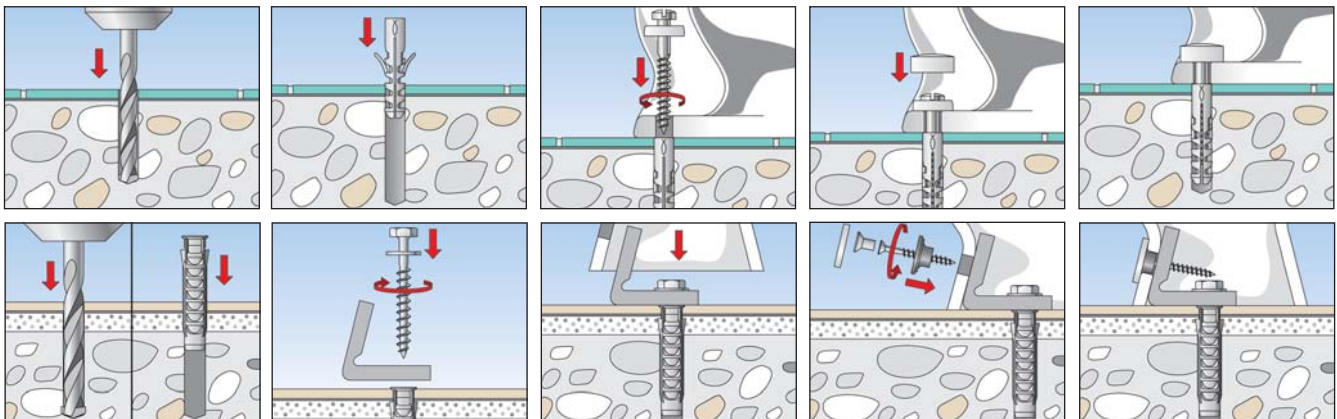

TECHNICAL DATA



Item	Art.-No.	Contents per plastic bag [pcs]	Sales unit [pcs]
WCN 1	060561	2 wall plugs S 8, 2 brass screws 6 x 70 hex., 2 cover caps white, 2 snap-fit sleeves	50
WCN 2	060562	2 wall plugs S 8, 2 brass screws 6 x 70 hex., 2 cover caps chrome, 2 snap-fit sleeves	50

TECHNICAL DATA



Item	Art.-No.	Contents per plastic bag [pcs]	Sales unit [pcs]
S 8 D 70 WCR	060564	2 wall plugs S 8, 2 brass screws 6 x 70 hex., 2 cover caps chrome and white, 2 snap-fit sleeves	50

TECHNICAL DATA



Item	Art.-No.	Contents per plastic bag [pcs]	Sales unit [pcs]
S 8 RD 60 WCR	060570	2 wall plugs S 8 RD 60, 2 brass screws 6 x 65 hex., 2 cover caps chrome and white	50
S 8 RD 80 WCR	060568	2 wall plugs S 8 RD 80, 2 brass screws 6 x 85 hex., 2 cover caps chrome and white	50

TECHNICAL DATA



Item	Art.-No.	Contents	Sales unit [pcs]
WB 5N	018652	2 S plugs SX 10, 2 Screws 7x65 zinc-plated, 2 Nylon angles, 2 washers 8mm, 2 screws A2 stainless steel, 2 flanged sleeves, 2 cover caps chrom	50

Complete fixing sets for wash basins, urinals and sanitary installations



Urinals



Wash basins

BUILDING MATERIALS

- Concrete
- Vertically perforated brick
- Hollow blocks made from lightweight concrete
- Perforated sand-lime brick
- Solid sand-lime brick
- Natural stone
- Aerated concrete
- Solid panel made from gypsum
- Solid brick made from lightweight concrete
- Solid brick

CHARACTERISTICS



ADVANTAGES

- Complete fixing sets allow for quick and easy installation.
- The universal plug UX can be used in solid and hollow materials, thus offering a high level of flexibility.
- Flanged nuts and collar sleeves made of high-strength nylon are resistant to ageing and chemicals, and guarantee a long-lasting fixing that will not damage the ceramics.
- Cover caps with a high-quality chrome finish ensure the fixture remains visually attractive for a long period of time.

APPLICATIONS

- Wash basins
- Urinals
- Built-in toilets
- Boilers
- Gas heaters
- Cisterns
- Consoles

FUNCTIONING

- The rimless UX is suitable for pre-positioned and push-through installation.
- Screwing in the screw causes the UX to expand in solid and hollow building material.
- Maximum load-bearing capacity is only achieved when the minimum screw-in depth is reached.
- Tiles and plaster are not classed as load-bearing base materials.

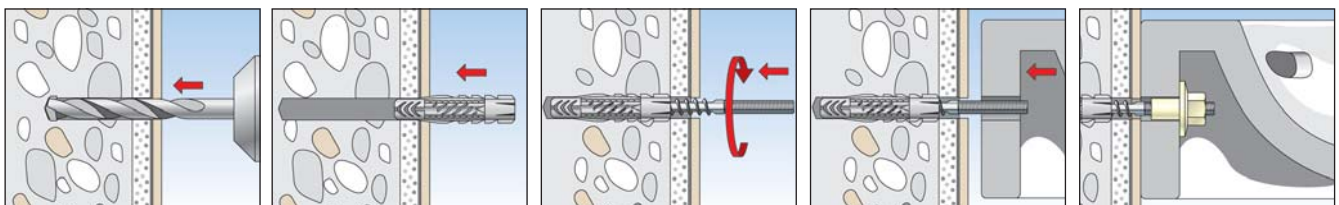

TECHNICAL DATA



Wash basin and urinal fixing **WD**

Item	Art.-No.	Contents per plastic bag	Sales unit
		[pcs]	[pcs]
WD 8 x 90	080659	2 wall plugs UX 10 x 60, 2 stud screws M8 x 90 zinc-plated, 2 flanged nuts BU M8	50
WD 8 x 110	080658	2 wall plugs UX 10 x 60, 2 stud screws M8 x 110 zinc-plated, 2 flanged nuts BU M8	50
WD 10 x 120	080655	2 wall plugs UX 14 x 75, 2 stud screws M10 x 120 zinc-plated, 2 flanged nuts BU M10 MH	50
WD 10 x 140	080656	2 wall plugs UX 14 x 75, 2 stud screws M10 x 140 zinc-plated, 2 flanged nuts BU M10 MH	50

TECHNICAL DATA



Boiler fixing **BO**

Item	Art.-No.	Contents per plastic bag	Sales unit
		[pcs]	[pcs]
BO 120	080654	4 wall plugs UX 14 x 75, 4 stud screws M10 x 120 zinc-plated, 4 flanged nuts BU M10	25

TECHNICAL DATA



Washbasin fixing **WST**

Item	Art.-No.	Contents per plastic bag	Sales unit
		[pcs]	[pcs]
WST 10 x 140	080660	2 wall plugs UX 14 x 75, 2 stud screws M10 x 140 zinc-plated, 2 hexagon nuts M10 zinc-plated, 2 flanged bushes BDH M10	50
WST 12 x 150	080661	2 wall plugs UX 14 x 75, 2 stud screws M12 x 150 zinc-plated, 2 hexagon nuts M12 zinc-plated, 2 flanged bushes BDH M12	50
WST 12 x 180	080662	2 wall plugs UX 14 x 75, 2 stud screws M12 x 180 zinc-plated, 2 hexagon nuts M12 zinc-plated, 2 flanged bushes BDH M12	50

TECHNICAL DATA



Urinal fixing **UST 8 x 110**



Urinal fixing **UST 10 x 120**

Item	Art.-No.	Contents per plastic bag	Sales unit
		[pcs]	[pcs]
UST 8 x 110	083578	2 wall plugs UX 10 x 60, 2 stud screws M8 x 110, 2 washers B 8.4 DIN 125, 2 plastic washer 8,4 x 16 x 1,6, 2 cap nuts FA 8, 2 cover caps chrome plated	50
UST 10 x 120	080668	2 wall plugs UX 14 x 75, 2 stud screws M10 x 120, 2 flanged nuts BU M10, 2 cover caps AKM 10 CR	10

TECHNICAL DATA



Sanitary fixing **WL**

Item	Art.-No.	Contents per plastic bag	Sales unit
		[pcs]	[pcs]
WL 7 x 60	080651	2 plugs S 10, 2 screws 7 x 65 hex. head zinc-plated, 2 washers zinc-plated	100
WL 8 x 70	080652	2 plugs S 10, 2 screws 8 x 70 hex. DIN 571 zinc-plated, 2 washers zinc-plated	100
WL 10 x 80	080650	2 plugs S 12, 2 screws 10 x 80 hex. DIN 571 zinc-plated, 2 washers zinc-plated	50

ACCESSORIES



Flanged nut **BUM**

Item	Art.-No.	Thread	Width across nut	Washer	Match	Sales unit
		M	○ SW [mm]	[mm]		[pcs]
BU M8 MH	060200	M 8	17	40	STS M8	25
BU M10 MH	060201	M 10	17	40	STS M10	25
BU M12 MH	060204	M 12	19	40	STS M12	25

ACCESSORIES



Cover cap **AKM**

Item	Art.-No.	Colour	Match	Sales unit
				[pcs]
AKM 10 W	080972	white	BU M10 MH	20
AKM 10 CR	080951	chrome	BU M10 MH	100
AKM 12 CR	080952	chrome	BU M12 MH	100

ACCESSORIES



Installation tool **HED**

Item	Art.-No.	Match	Sales unit
			[pcs]
HED	079831	M6, M8, M10, M12	1

INSTALLATION DATA

Item	Art.-No.	Drill diameter	Min. drill hole depth	Usable length (with assembled flanged nut)	Min. bolt penetration
		d_0 [mm]	h_1 [mm]	t_{fix} [mm]	$l_{E,min}$ [mm]
WD 8 x 90	080659	10	75	5	68
WD 8 x 110	080658	10	75	25	68
WD 10 x 120	080655	14	95	18	85
WD 10 x 140	080656	14	95	38	85
BO 120	080654	14	95	18	85
WST 10 x 140	080660	14	95	38	85
WST 12 x 150	080661	14	95	48	85
WST 12 x 180	080662	14	95	78	85
UST 8 x 110	083578	10	75	32	68
UST 10 x 120	080668	14	95	18	85
WL 7 x 60	080651	10	70	10	57
WL 8 x 70	080652	10	70	12	58
WL 10 x 80	080650	12	80	10	70

LOADS

Washbasin and urinal fixings

Highest recommended loads¹⁾ for a single anchor.

The given loads are valid for stud screws with the specified diameter.

Type	Screw diameter \emptyset [mm]	WD 8x90	WD 10x120	WST 10x140	WST 12x150	UST 8x110	UST 10x120	WL 7x60	WL 8x70	WL 10x80
		WD 8x110	WD 10x140	BO 120	WST 12x180					
Screw diameter \emptyset [mm]		8	10	10	12	8	10	7	8	10
Recommended loads in the respective base material F_{rec}²⁾										
Concrete $\geq C20/25$	[kN]	0,90	0,90	0,90	1,80	0,90	0,90	1,10	1,10	1,50
Solid brick $\geq Mz 12$	[kN]	0,50	0,50	0,50	0,80	0,50	0,50	- ³⁾	- ³⁾	- ³⁾
Perforated sand-lime brick $\geq KSL 12$	[kN]	0,40	0,40	0,40	0,80	0,40	0,40	-	-	-
Vertically perforated brick $\geq Hlz 12$	[kN]	0,20	0,30	0,30	0,40	0,20	0,30	-	-	-
Aerated concrete $\geq PB 4, PP 4 (G4)$	[kN]	0,30	0,30	0,30	0,70	0,30	0,30	0,16	0,16	0,28

¹⁾ Required safety factors are considered.





²⁾ Valid for tensile load, shear load and oblique load under any angle.

³⁾ Due to that the failure of the substrate varies too much no reproducible values can be given.





10 Scaffold and eye screw fixings

		Page
Scaffold anchoring GS 12 + plug		466
Scaffold anchoring FI G		468
Eye screw GS		470
Ring nut RI		472

The standard scaffold anchoring



Scaffold anchoring



Façade scaffolds

BUILDING MATERIALS

GS 12 + S 14 ROE suitable for:

- Concrete
- Solid sand-lime brick
- Natural stone with dense structure
- Solid brick
- Solid brick made from lightweight concrete

GS 12 + S 16 H R suitable for:

- Vertically perforated brick
- Perforated sand-lime brick
- Aerated concrete

CERTIFICATES



ADVANTAGES

- The ideal interaction of the scaffold eyebolt and plug allows for a high load-bearing capacity, thus providing increased safety.
- The high-quality weld stops the eye from opening.
- The large diameter of the cover caps (available separately) covers drill holes completely and discreetly, even those with slightly broken edges.

APPLICATIONS

- Façade scaffolds
- Ropes
- Chains
- Trellises
- Lighting
- Clothes lines
- Hanging baskets

FUNCTIONING

- In order to achieve the maximum load-bearing capacity, nylon plugs should only be used once.
- The combination with plug S 16 H R is recommended for perforated brick and aerated concrete.
- The screw-in markings provide a visual control during assembly, and thus allow for a simple and problem-free installation.
- Pre-drill into wood when not using plugs. The drill bit diameter should equal the core diameter of the screw.
- Suitable cover caps AD 12x40 (see page 469) for closing off remaining drill holes for S14 ROE.
- Not suitable for swings, hammocks etc.

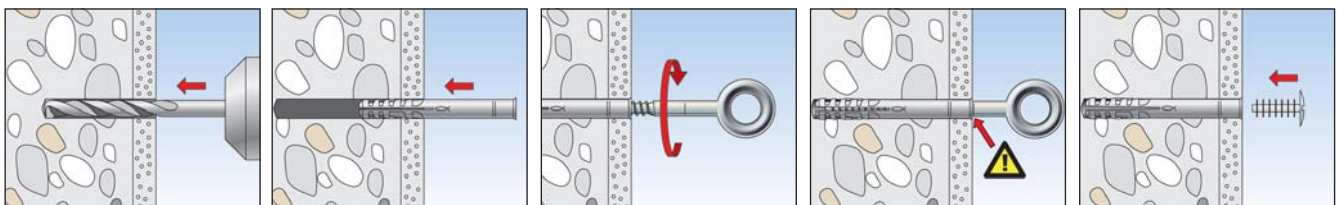

TECHNICAL DATA



Scaffold eyebolt **GS 12**

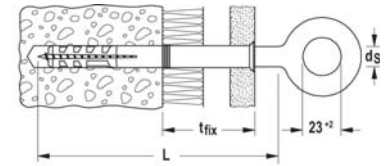

Item	Art.-No.	Shaft diameter d_s [mm]	Shaft length L [mm]	Max. thickness of non-bearing layer t_{fix} [mm]	Eye- \emptyset [mm]	Match	Sales unit [pcs]
GS 12 x 90	080925	12	90	15	23	S 14 ROE 70	25
GS 12 x 120	080926	12	120	30 / 10	23	S 14 ROE 100 / S 16 H 100 R	25
GS 12 x 160	080927	12	160	65 / 45	23	S 14 ROE 135 / S 16 H 135 R	25
GS 12 x 190	080960	12	190	110 / 70	23	S 14 ROE 185 / S 16 H 160 R	25
GS 12 x 230	080961	12	230	110 / 70	23	S 14 ROE 185 / S 16 H 160 R	25
GS 12 x 300	081269	12	300	110 / 70	23	S 14 ROE 185 / S 16 H 160 R	25
GS 12 x 350	080962	12	350	110 / 70	23	S 14 ROE 185 / S 16 H 160 R	25

TECHNICAL DATA



Plug **S 14 ROE**



Plug **S 16 H R**

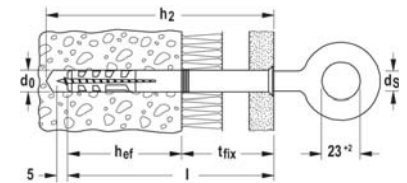

Item	Art.-No.	Drill hole diameter d_0 [mm]	Min. drill hole depth for through fixings h_2 [mm]	Effect. anchorage depth h_{ef} [mm]	Anchor length l [mm]	Max. thickness of non-bearing layer t_{fix} [mm]	Min. bolt penetration $l+5$ [mm]	Sales unit [pcs]
S 14 ROE 70	052160	14	80	70	70	—	75	25
S 14 ROE 100	052161	14	110	70	100	30	105	25
S 14 ROE 135	052162	14	145	70	135	65	140	25
S 14 ROE 185	052164	14	195	70	185	110	190	25
S 16 H 100 R	059187 ¹⁾	16	120	90	100	10	105	50
S 16 H 135 R	059188 ¹⁾	16	155	90	135	45	140	50
S 16 H 160 R	059189 ¹⁾	16	180	90	160	70	165	50

¹⁾ Also suitable for screws with metric thread M12.

LOADS

Scaffold anchoring S 14 ROE / S 16 H R + GS 12

Mean ultimate loads¹⁾ for tension of a single anchor.

Type	S 14 ROE + GS 12		S 16 H R + GS 12	
Mean ultimate loads for tension in the respective base material N_u				
Concrete	$\geq C20/25$	[kN]	14,5	-
Solid brick	$\geq Mz 12$	[kN]	13,0	-
Solid sand-lime brick	$\geq KS 12$	[kN]	14,5	-
Solid brick of lightweight aggregate concrete	$\geq V 2$	[kN]	3,0	-
Perforated sand-lime brick	$\geq KSL 12$	[kN]	-	5,0
Vertically perforated brick	$\geq Hlz 12$	[kN]	-	3,5
Aerated concrete	$\geq AAC 4$	[kN]	3,0	3,0

¹⁾ On these values an appropriate safety factor has to be considered.

The scaffold anchoring with metric thread M 12



Scaffold anchoring



Façade scaffolds

BUILDING MATERIALS

When combined with internal threaded anchor:

- Concrete C20/25 - C50/60:
Injection mortar FIS EM / FIS V
Internal threaded anchor
RG 18x125 M12 I,
Art.-No. 50562 /
ZYKON undercut anchor FZA-I
FZA 22x100 M12 I, Art.-No. 060763
- Masonry:
Injection mortar FIS V 360 S
Perforated sleeve FIS H 20x85 K,
Art.-No. 41904 /
Internal threaded anchor
FIS E 15x85 M12,
Art.-No. 43634

ADVANTAGES

- When used together with an internal threaded anchor or a steel fixture with internal thread M 12, the scaffold screw FI G allows for repeated installation and removal using the same fixing point.
- The high-quality weld stops the eye from opening, thus providing increased safety.

APPLICATIONS

- Façade scaffolds
- Trellises
- Tensioning ropes
- Chains
- Lighting
- Clothes lines
- Hanging baskets

FUNCTIONING

- The scaffold anchoring FI G should be used with an internal threaded anchor. Detailed information about its functioning can be found in the „Chemical fixings“ chapter.
- Not suitable for swings, hammocks etc.

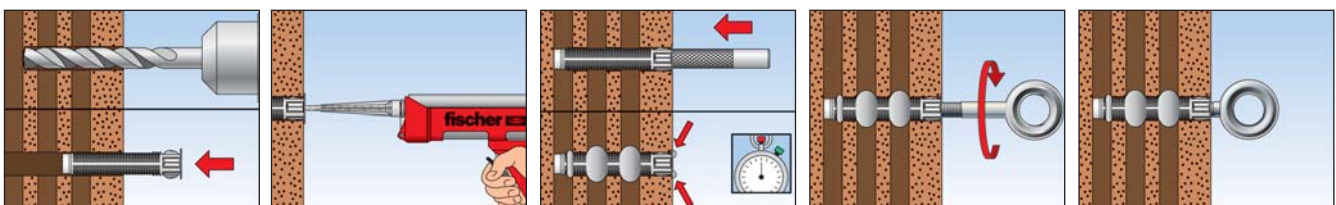

TECHNICAL DATA



Scaffold eyebolt **FI G 12**

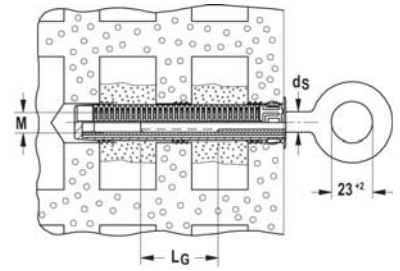

Item	Art.-No.	Thread	Thread length L_G [mm]	Shaft diameter d_s [mm]	Max. thickness of non-bearing layer t_{fix} [mm]	Eye-Ø [mm]	Sales unit [pcs]
FI G 12 x 40	080933	M 12	30	12	40	23	20
FI G 12 x 80	080934	M 12	30	12	80	23	20

ACCESSORIES

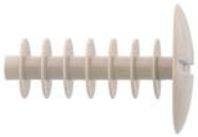

Cover cap **AD 12 x 40**

Item	Art.-No.	Colour	Length l [mm]	Head height [mm]	Match	Sales unit [pcs]
AD 12 x 40 W	060259	white	40	3	Plug-Ø 14 mm	100
AD 12 x 40 G	060260	grey	40	3	Plug-Ø 14 mm	100

The universal eye screw for use with fischer plugs or for direct use in wood



BUILDING MATERIALS

GS 8 + SX 10 suitable for:

- Concrete
- Solid brick
- Perforated brick
- Aerated concrete

GS 10 + S 12 R suitable for:

- Concrete
- Solid brick

GS 10 + S 14 H R suitable for:

- Perforated brick

GS 8 or GS 10 without plug suitable for:

- Wood

CERTIFICATES



ADVANTAGES

- The ideal interaction of the eye screw and plug allows for a high load-bearing capacity, thus providing increased safety.
- The high-quality weld stops the eye from opening.

APPLICATIONS

- Ropes
- Chains
- Trellises
- Lighting
- Clothes lines
- Hanging baskets

FUNCTIONING

- Pre-drill when using with wood. The drill bit diameter should equal the core diameter of the screw.
- The maximum load-bearing capacity is achieved when combined with the plugs recommended by fischer (see table "Technical Data"). The nylon plug must only be used once.
- Not suitable for swings, hammocks etc.

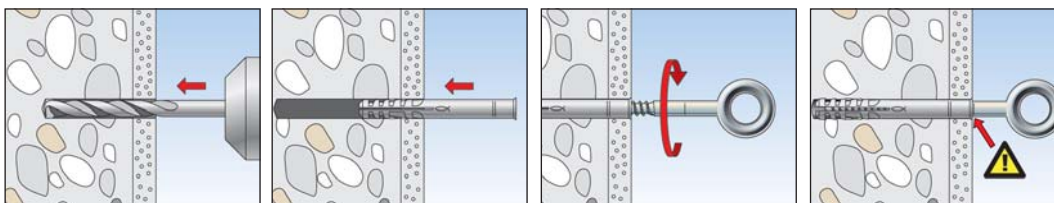

TECHNICAL DATA



Eye screw **GS**

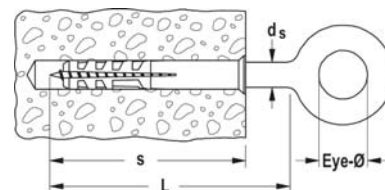

Item	Art.-No.	Shaft diameter d_s [mm]	Shaft length L [mm]	Bolt penetration s [mm]	Match	Eye-Ø [mm]	Sales unit [pcs]
GS 8 x 50 Ø15	502620	8	50	50	SX 10	15	20
GS 8 x 80 Ø15	540677	8	80	58	SX 10	15	20
GS 8 x 120 Ø15	540678	8	120	58	SX 10	15	20
GS 8 x 80 Ø22	080918	8	80	58	SX 10	22	20
GS 8 x 100 Ø22	080919	8	100	58	SX 10	22	20
GS 8 x 120 Ø22	080920	8	120	58	SX 10	22	20
GS 10 x 160 Ø30	080929	10	160	–	S 12 R, S 14 H R, SX12	30	20

TECHNICAL DATA



Plug **S 12 R**



Plug **S 14 H R**

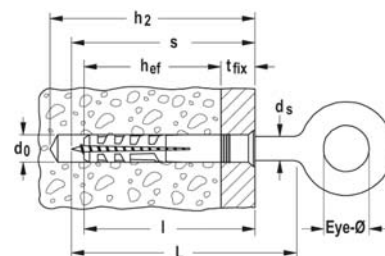

Item	Art.-No.	Drill hole diameter d_0 [mm]	Min. drill hole depth for through fixings h_2 [mm]	Bolt penetration s [mm]	Effect. anchorage depth h_{ef} [mm]	Anchor length l [mm]	Max. fixture thickness t_{fix} [mm]	Sales unit [pcs]
S 12 R 100	050177	12	120	110	60	100	40	100
S 12 R 135	050178	12	155	145	60	135	75	100
S 14 H 100 R	059179	14	120	110	90	100	10	50
S 14 H 135 R	059180	14	155	145	90	135	45	50

LOADS

Eye screw GS

Highest recommended tensile loads¹⁾ for a single anchor.

The given loads are valid for the eye screw GS with the specified fischer plugs.

Type	SX 10x50 + GS 8	SX 12 + GS 10	S 12 R + GS 10	S 14 H-R + GS 10
Recommended tensile loads in the respective base material N_{rec}				
Concrete $\geq C12/15$	[kN] 1,20	1,70	1,03	-
Solid brick $\geq Mz 12$	[kN] 0,65	0,70	1,00	-
Solid sand-lime brick $\geq KS 12$	[kN] 1,20	1,70	0,84	-
Solid brick of lightweight aggregate concrete $\geq V 4$	[kN] -	-	0,29	0,43
Perforated sand-lime brick $\geq KSL 12$	[kN] 0,35	0,35	0,30	0,34
Vertically perforated brick $\geq Hlz 12 (\rho \geq 1 \text{ kg/dm}^3)$	[kN] -	-	0,36	0,50
Aerated concrete $\geq AAC 2$	[kN] 0,09	0,20	-	-
Aerated concrete $\geq AAC 4$	[kN] 0,30	0,60	-	-

¹⁾ Required safety factors are considered.

The ring nut for all fixings with threaded studs



Transmission of loads

BUILDING MATERIALS

In line with the anchor used:

- Concrete, cracked and non-cracked
- Solid and perforated brick

ADVANTAGES

- The metric internal thread gives the ring nut RI flexibility and means it can be used with a range of steel anchors or threaded rods; e.g. FH II, FHB II-A, RG M, FZA, FAZ II, FIS A.

APPLICATIONS

- Ropes
- Chains
- Trellises
- Lighting
- Clothes lines
- Hanging baskets

FUNCTIONING

- The ring nut is to be used with an anchor with threaded studs. Detailed information about its functioning can be found in the „High performance steel anchors“ and „Chemical fixings“ chapters. The following anchors, for example, can be used: FHB II, RG M, FZA, FAZ II, FIS A.
- Not suitable for swings, hammocks etc.

TECHNICAL DATA



Ring nut **RI**

Item	Art.-No.	Match	Eye-Ø [mm]	Total height [mm]	Sales unit [pcs]
RI M 8	080840	M 8	20	36	20
RI M 10	080842	M 10	25	45	10
RI M 12	080844	M 12	30	53	10



LOADS

Ring nut RI

Highest recommended loads¹⁾ for ring nuts.

The given loads apply for the use of ring nuts as permanent anchorage. For varying use at different components to be lifted ring nuts with next larger thread diameter has to be use (see DIN 582).

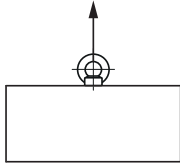
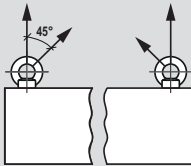
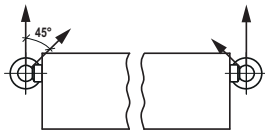











Type		RIM 8	RIM 10	RIM 12	
Thread size	[M]	M 8	M 10	M 12	
Recommended load per ring nut for respective set-up F_{rec}					
Axial tension on single ring nut		[kN]	1,40	2,30	3,40
Axial tension or oblique tension up to 45° on a group of two ring nuts		[kN]	1,00	1,70	2,40
Shear or oblique tension up to 45° on a group of two ring nuts for lateral set-up		[kN]	0,70	1,15	1,70

¹⁾ Required safety factors are considered.





11 Insulation fixings / Façade fixings

		Page
Insulation support DHK		476
Insulation support DHM		478
Render fixing DIPK		480
Render fixing FIF-PN 8		482
Render fixing FIF-CN II 8		485
Render fixing FIF-CS 8		488
Insulation discs		490
Retaining disc with screw DHT S		492
Insulation fixing FID		494
Insulation fixing FID GREEN		496
Holding clamp DVN		498
Fibre cement panel screw FAFZ H		499

The cost-effective plastic insulation support for all conventional insulating boards

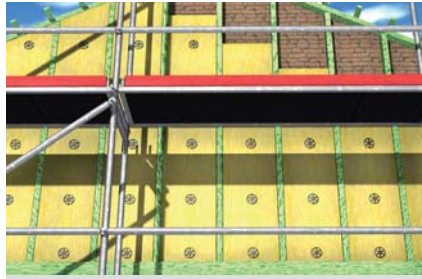
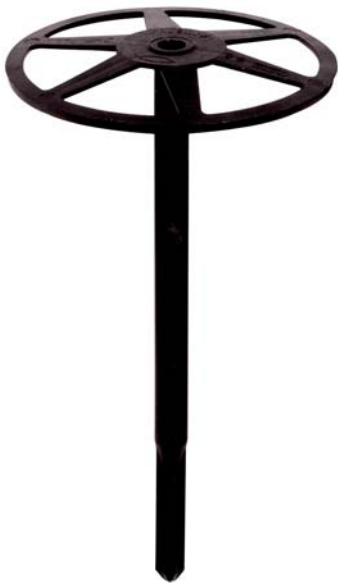

Insulating materials in rear-ventilated façades

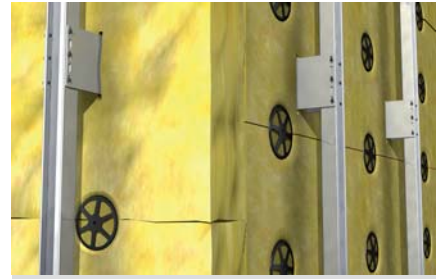

Insulating materials in rear-ventilated façades

BUILDING MATERIALS

- Concrete
- Hollow blocks made from lightweight concrete
- Vertically perforated brick
- Perforated sand-lime brick
- Solid sand-lime brick
- Natural stone with dense structure
- Aerated concrete
- Solid brick made from lightweight concrete
- Solid brick

ADVANTAGES

- The optimised geometry of the expansion section ensures a low anchorage depth and reduces the amount of drilling required.
- Flexible pins in the plate area adapt to the insulating material, and ensure a sustained contact pressure.
- The simple hammer-set installation allows for a quick installation process and thus reduces workload.
- The colouring of the DHK means that it does not stand out on black clad insulating material in rear-ventilated façades.
- The DHK 45 is suitable for use in pressure-resistant insulating boards and reveals.

APPLICATIONS

To fix soft and pressure-resistant insulating materials in rear-ventilated façades, such as:

- Mineral / glass wool
- PU panels
- Light building boards made of wood wool
- Cork boards / coir matting
- Polystyrene
- Foam glass tiles

FUNCTIONING

- The DHK is set in push-through installation using a hammer.
- The plate size of the insulation support is to be selected in line with the compressive strength of the insulating material: DHK 45 for pressure-resistant; DHK 90 for soft insulating materials.
- The expansion of the ribs in the drill hole gives the DHK an ideal contact pressure.
- Temperature range when installed: -40 °C to +80 °C.

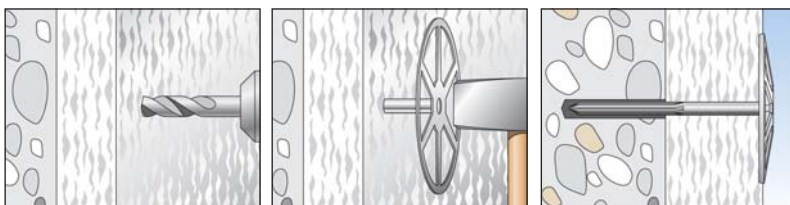

TECHNICAL DATA



Insulation support **DHK 45**,
plate-ø 45 mm



Insulation support **DHK**,
plate-ø 90 mm

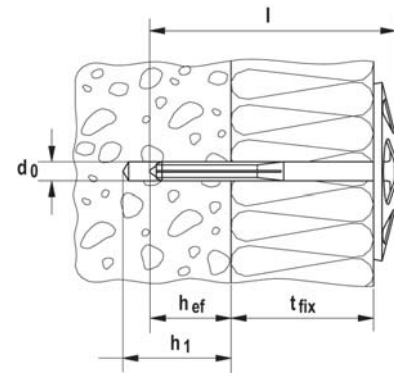

Item	Art.-No.	Drill hole diameter d_0 [mm]	Min. drill hole depth h_1 [mm]	Effect. anchorage depth h_{ef} [mm]	Anchor length l [mm]	Max. fixture thickness t_{fix} [mm]	Sales unit [pcs]
DHK 40	080937	8	30	20	65	40	250
DHK 60	080938	8	30	20	85	60	250
DHK 80	080939	8	30	20	105	80	250
DHK 100	080940	8	30	20	125	100	250
DHK 120	080941	8	30	20	145	120	200
DHK 140	080949	8	30	20	165	140	200
DHK 160	512150	8	30	20	185	160	100
DHK 180	512151	8	30	20	205	180	100
DHK 200	512153	8	30	20	225	200	100
DHK 220	512154	8	30	20	245	220	100
DHK 45/40	080892	8	30	20	65	40	250
DHK 45/60	080893	8	30	20	85	60	250
DHK 45/80	080894	8	30	20	105	80	250
DHK 45/100	080895	8	30	20	125	100	250

LOADS

Insulation support DHK

Highest recommended loads¹⁾ for a single anchor.

Type	DHK		
Recommended loads in the respective base material F_{rec}²⁾			
Concrete	≥ C12/15	[kN]	0,03
Solid brick	Mz 12	[kN]	0,03
Solid sand-lime brick	KS 12	[kN]	0,03
Perforated sand-lime brick	KSL 6	[kN]	0,03
Vertically perforated brick	HIz 12	[kN]	0,02
Aerated concrete	≥ PB 2, PP 2 (G2)	[kN]	0,02

¹⁾ Required safety factors are considered.

²⁾ Valid for tensile load.

The fire-protection-tested metal insulation support for fire-resistant insulating boards



BUILDING MATERIALS

- Concrete
- Hollow blocks made from lightweight concrete
- Vertically perforated brick
- Perforated sand-lime brick
- Solid sand-lime brick
- Natural stone with dense structure
- Aerated concrete
- Solid brick made from lightweight concrete
- Solid brick

CERTIFICATES



ADVANTAGES

- The metal insulation support achieves fire resistance F 120. This means that it can be used where there are fire resistance requirements.
- The DTM 80 plate for soft insulating materials (available separately) simplifies storage and minimises costs.
- The simple hammer-set installation allows for a quick installation process and thus reduces workload.
- The shaft geometry allows setting in aerated concrete without pre-drilling, thus saving a stage of installation.
- Stainless steel version DHM A2 (1.4301) for wet and exterior applications.

APPLICATIONS

To fix fire-resistant soft or pressure-resistant insulating materials, such as:

- Mineral / glass wool
- Light building boards made of wood wool
- Foam glass tiles

Also suitable for:

- Polystyrene boards
- Coir matting

FUNCTIONING

- The insulation support is set in push-through installation using a hammer.
- The spring steel expands when hammered into the base material.
- Use the DTM 80 plate (available separately) to fix soft insulating materials.

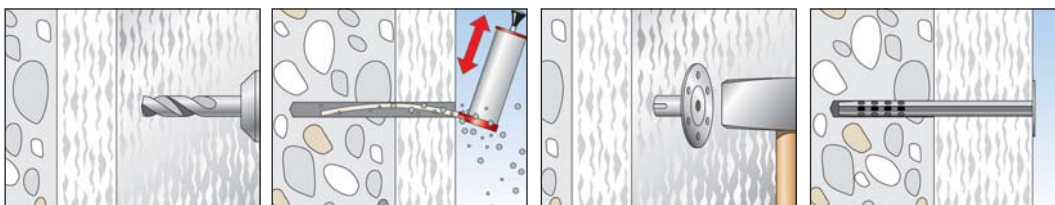

TECHNICAL DATA

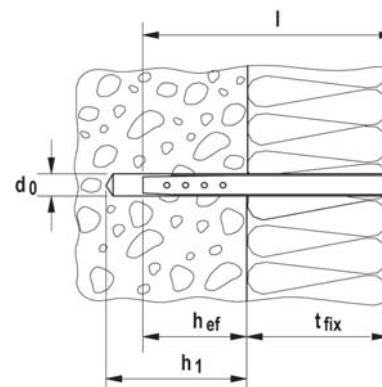

Insulation support metal **DHM**,
washer-ø 35 mm

Insulation retaining metal washer **DTM 80**,
washer-ø 80 mm, inside-ø 11 mm

Item	Hot-dip galva- nised steel	Stainless steel A2	Approval DIBt	Drill hole dia- meter	Min. drill hole depth	Effect. anchorage depth	Anchor length	Usable length	Sales unit
	Art.-No.	Art.-No.		d_0 [mm]	h_1 [mm]	h_{ef} [mm]	l [mm]	t_{fix} [mm]	[pcs]
	hdg	A2							
DHM 40	536253	536262	•	8	50	40	80	10 - 40	250
DHM 70	536254	536264	•	8	50	40	110	40 - 70	250
DHM 100	536256	536265	•	8	50	40	140	70 - 100	250
DHM 130	536257	536266	•	8	50	40	170	100 - 130	250
DHM 160	536258	536267	•	8	50	40	200	130 - 160	250
DHM 210	536259	536268	•	8	50	40	250	170 - 210	125
DHM 260	536260	536269	•	8	50	40	300	220 - 260	125
DTM 80	536261	536271	•	—	—	—	—	—	250

ACCESSORIES



Cover cap **DHM ADK-W**



Cover cap **DHM ADK-GR**



Cover cap **DHM ADK-BG**

Item	Art.-No.	Diameter d [mm]	Colour	Outer carton [pcs]	Sales unit [pcs]
DHM ADK-W	013330	37	white	5000	250
DHM ADK-GR	046843	37	grey	10000	250
DHM ADK-BG	046844	37	beige	2500	250

LOADS

Insulation support DHM

Highest recommended loads¹⁾ for a single anchor.

Type	DHM		
Recommended loads in the respective base material F_{rec}²⁾			
Concrete ³⁾	$\geq C12/15$	[kN]	0,25
Solid brick	Mz 12	[kN]	0,25
Solid sand-lime brick	KS 12	[kN]	0,25
Aerated concrete (without pre-drilling)	$\geq PB 2, PP 2 (G2)$	[kN]	0,10

¹⁾ Required safety factors are considered.

²⁾ Valid for tensile load.

³⁾ Acc. to German approval in cracked concrete 0,07 kN. The complete approval has to be considered.

The cost-effective drive anchor with plastic nail

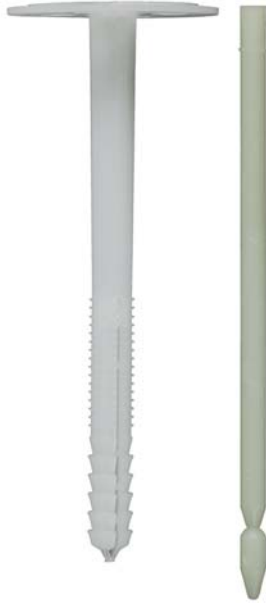

Pressure-resistant insulation boards with rendering

BUILDING MATERIALS

- Concrete
- Hollow blocks made from lightweight concrete
- Vertically perforated brick
- Perforated sand-lime brick
- Solid sand-lime brick
- Natural stone with dense structure
- Solid brick

ADVANTAGES

- The glass-fibre-reinforced plastic nail (GRP nail) reduces the heat transmission and prevents marks on the plaster surface.
- The simple hammerset installation allows for a quick installation process and thus reduces workload.
- The well-proven design with low anchorage depth reduces the amount of drilling required, thus achieving a high level of efficiency.
- The DIPK can be used universally in rear-ventilated curtain façades, as well as in plaster façades.
- The surface of the anchor plate is suitable to use as a plaster base

APPLICATIONS

To fix pressure-resistant insulating materials in façades, such as:

- Polystyrene boards
- Light building boards made of wood wool
- Cork boards / coir matting
- PU panels

FUNCTIONING

- Non-bearing layers, such as adhesive and/or old render, are to be included in the anchor's useful length.
- The DIPK is set in push-through installation using a hammer.
- In solid materials the GRP nail needs to be shortened at the predetermined breaking point.
- Driving the nail into the anchor shaft causes the DIPK to expand in the base material.

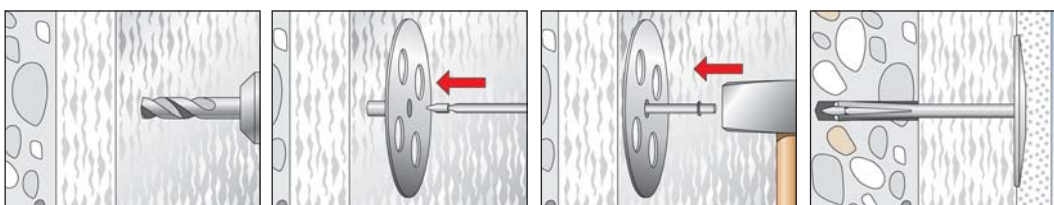

TECHNICAL DATA

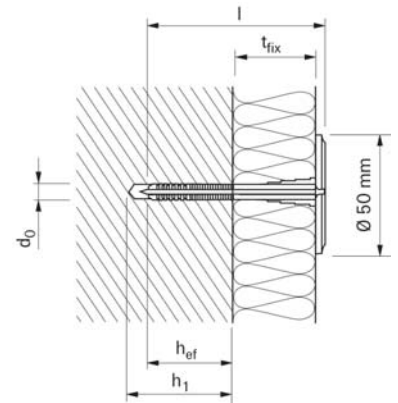

Item	Art.-No.	Drill hole diameter	Usable length	Min. drill hole depth	Effect. anchorage depth	Nail length	Fixing length	Sales unit
		d_0 [mm]	t_{fix} [mm]	h_1 [mm]	h_{ef} [mm]	[mm]	l [mm]	[pcs]
DIPK 8/20-40	041865	8	20 - 40	40	30	77	70	200
DIPK 8/40-60	041866	8	40 - 60	40	30	97	90	200
DIPK 8/60-80	041867	8	60 - 80	40	30	117	110	200
DIPK 8/80-100	041868	8	80 - 100	40	30	137	130	200
DIPK 8/100-120	041869	8	110 - 120	40	30	157	150	200
DIPK 10/10-30	043966	10	10 - 30	40	30	67	60	200
DIPK 10/40-60	043967	10	40 - 60	40	30	97	90	200
DIPK 10/60-80	043968	10	60 - 80	40	30	117	110	200
DIPK 10/80-100	043969	10	80 - 100	40	30	137	130	200
DIPK 10/100-120	043970	10	110 - 120	40	30	157	150	200
DIPK 10/120-140	043971 ¹⁾	10	120 - 140	40	30	117	170	200
DIPK 10/140-160	043972 ¹⁾	10	140 - 160	40	30	137	190	200

1) Installation with setting tool, included in each package.

The pre-assembled drive anchor with reinforced plastic nail



Polystyrene rigid foam boards



Setting the hammer set fixing on polystyrene rigid foam boards

BUILDING MATERIALS

- Building material classes A, B, C, D, E
- Concrete
- Building brick
- Solid sand-lime brick
- Hollow blocks made from lightweight concrete
- Vertically perforated brick
- Perforated sand-lime brick
- Lightweight aggregate concrete
- Aerated concrete

APPROVALS



ADVANTAGES

- To set with few hammer blows.
- The disc fits tight into the insulation thanks to its thickness of only 2.5 mm. Thus allows the application of low-cost, thin reinforcement layers.
- Optimised retention forces thanks to the glass fibre reinforced plastic nail (GRP).
- Small anchoring depth of 35 mm saves on drilling times.
- Thanks to the GRP nail, the fixing is free of thermal bridging with the Chi value 0.000 [W/K].
- The compression zone in the shank allows the disc to be drawn precisely into the insulation.
- For insulating material thicknesses up to 180 mm.

APPLICATIONS

- Attachment of ETICS insulating boards on concrete and masonry
- Flush-to-surface installation in ETICS insulating materials e.g. polystyrene

FUNCTIONING

- The fixing is set in push-through installation.
- Simple, fast setting by driving the GRP nail in using a standard hammer.
- Non load bearing layers such as adhesive and old plaster are included in the maximum useful length.

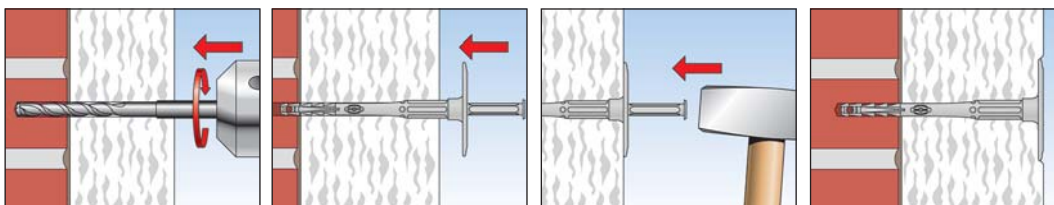

TECHNICAL DATA



Render fixing **FIF-PN 8**

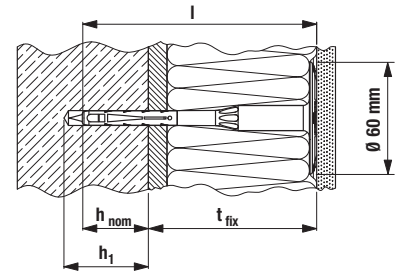

t_{fix} = thickness of insulation + glue + old render

For building material categorie A, B, C

Item	Art.-No.	Approval ETA	Drill hole diameter d_0 [mm]	Min. drill hole depth h_1 [mm]	Min. anchorage depth h_{nom} [mm]	Anchor length l [mm]	Max. fixture thickness t_{fix} [mm]	Disc Ø [mm]	Sales unit [pcs]
FIF-PN 8/60	546803	■	8	45	35	108	70	60	100
FIF-PN 8/80	546804	■	8	45	35	128	90	60	100
FIF-PN 8/100	546805	■	8	45	35	148	110	60	100
FIF-PN 8/120	546806	■	8	45	35	168	130	60	100
FIF-PN 8/140	546807	■	8	45	35	188	150	60	100
FIF-PN 8/160	546808	■	8	45	35	208	170	60	100
FIF-PN 8/180	546809	■	8	45	35	228	190	60	100

For building material categorie D, E

Item	Art.-No.	Approval ETA	Drill hole diameter d_0 [mm]	Min. drill hole depth h_1 [mm]	Min. anchorage depth h_{nom} [mm]	Anchor length l [mm]	Max. fixture thickness t_{fix} [mm]	Disc Ø [mm]	Sales unit [pcs]
FIF-PN 8/60	546803	■	8	65	55	108	50	60	100
FIF-PN 8/80	546804	■	8	65	55	128	70	60	100
FIF-PN 8/100	546805	■	8	65	55	148	90	60	100
FIF-PN 8/120	546806	■	8	65	55	168	110	60	100
FIF-PN 8/140	546807	■	8	65	55	188	130	60	100
FIF-PN 8/160	546808	■	8	65	55	208	150	60	100
FIF-PN 8/180	546809	■	8	65	55	228	170	60	100

LOADS

Render fixing FIF-PN 8

Highest permissible loads for a single anchor^{1) 4)} for fixing of external thermal insulation composite systems with rendering.

For the design the complete assessment ETA-18/0253 has to be considered.

Base material	Brick raw density ρ [kg/dm ³]	Minimum compressive brick strength f_b [N/mm ²]	Min. embedment depth h_{nom} [mm]	Min. member thickness h_{min} [mm]	Beton und Mauerwerk ⁵⁾		
					Permissible tensile load ³⁾	Minimum spacing ²⁾	Minimum edge distance ²⁾
					N_{perm} [kN]	s_{min} [mm]	c_{min} [mm]
Concrete according to EN 206-1:2013							
FIF-PN 8	C12/15 - C50/60		35 ⁶⁾	100	0,17	100	100
Solid clay bricks Mz according to EN 771-1:2011							
FIF-PN 8	≥ 2,0	12	35 ⁶⁾	100	0,17	100	100
Vertically perforated clay bricks HLz according to EN 771-1:2011							
FIF-PN 8	≥ 1,0	12	35 ⁷⁾	100	0,13	100	100
Lightweight aggregate concrete LAC according to EN 1520:2011							
FIF-PN 8	≥ 0,8	6	55 ⁶⁾	100	0,10	100	100
Autoclaved aerated concrete blocks AAC according to EN 771-4:2011							
FIF-PN 8	≥ 0,5	6	55 ⁷⁾	100	0,10	100	100

¹⁾ The partial safety factors for material resistance as regulated in the assessment as well as a partial safety factor for load actions of $\gamma_F = 1,5$ are considered.

²⁾ Possible minimum spacing resp. edge distance according to assessment.

³⁾ Plastic anchor for fixing of external thermal insulation composite systems with rendering according to ETAG014. Only tensile wind loads are permitted.

⁴⁾ The given loads are valid for installation and use of fixations in dry base material for temperatures in the substrate up to +24 °C (resp. short term up to +40 °C).

⁵⁾ Restrictions concerning the manufacturer and the permissible hole patterns as well as the web thickness see assessment.

⁶⁾ Drill method hammer drilling.

⁷⁾ Hammer drilling.

The pre-assembled drive anchor with innovative steel-plastic nail

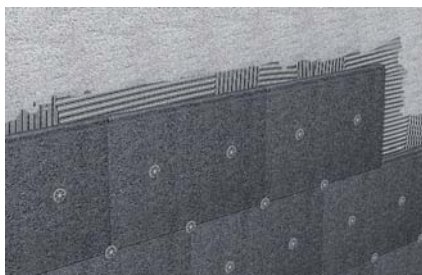

Additional reinforcement of ETICS



Detail: innovative steel-plastic combination

BUILDING MATERIALS

- Building material classes A, B, C, D, E
- Concrete
- Full blocks made from concrete
- Building brick
- Solid sand-lime brick
- Hollow blocks made from lightweight concrete
- Vertically perforated brick
- Perforated sand-lime brick
- Lightweight aggregate concrete
- Aerated concrete

APPROVALS



ADVANTAGES

- To set with few hammer blows.
- The disc fits tight into the insulation thanks to its thickness of only 2.5 mm. Thus allows the application of low-cost, thin reinforcement layers.
- High retention forces thanks to the steel tip of the compound nail.
- Small anchoring depth of 35 mm saves on drilling times.
- The FIF-CN II 8 is virtually free of thermal bridging due to the compound nail.
- The compression zone in the shank allows the disc to be drawn in precisely.
- For insulating material thicknesses up to 340 mm.

APPLICATIONS

- Attachment of ETICS insulating boards on concrete and masonry
- Flush-to-surface installation in ETICS insulating materials and mineral wool e.g. polystyrene

FUNCTIONING

- The fixing is set in push-through installation.
- Simple, fast setting by driving the compound nail in using a standard hammer.
- Non load bearing layers such as adhesive and old plaster are included in the maximum useful length.

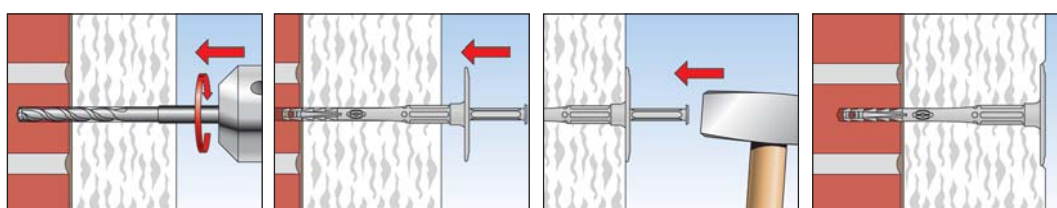

TECHNICAL DATA



Render fixing **FIF-CN II 8**

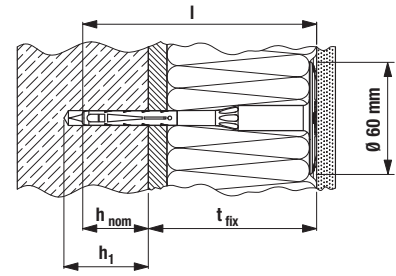

t_{fix} = thickness of insulation + glue + old render

For building material categorie A, B, C

Item	Art.-No.	Approval ETA	Drill hole diameter d_0 [mm]	Min. drill hole depth h_1 [mm]	Min. anchorage depth h_{nom} [mm]	Anchor length l [mm]	Max. fixture thickness t_{fix} [mm]	Disc \varnothing [mm]	Sales unit [pcs]
FIF-CN II 8/60	546443	■	8	45	35	108	70	60	100
FIF-CN II 8/80	546444	■	8	45	35	128	90	60	100
FIF-CN II 8/100	546445	■	8	45	35	148	110	60	100
FIF-CN II 8/120	546446	■	8	45	35	168	130	60	100
FIF-CN II 8/140	546447	■	8	45	35	188	150	60	100
FIF-CN II 8/160	546448	■	8	45	35	208	170	60	100
FIF-CN II 8/180	546449	■	8	45	35	228	190	60	100
FIF-CN II 8/200	546450	■	8	45	35	248	210	60	100
FIF-CN II 8/220	546451	■	8	45	35	268	230	60	100
FIF-CN II 8/240	546452	■	8	45	35	288	250	60	100
FIF-CN II 8/260	546453	■	8	45	35	308	270	60	100
FIF-CN II 8/280	546454	■	8	45	35	328	290	60	100
FIF-CN II 8/300	546455	■	8	45	35	348	310	60	100
FIF-CN II 8/320	546456	■	8	45	35	368	330	60	100
FIF-CN II 8/340	546457	■	8	45	35	388	350	60	100

For building material categorie D, E

Item	Art.-No.	Approval ETA	Drill hole diameter d_0 [mm]	Min. drill hole depth h_1 [mm]	Min. anchorage depth h_{nom} [mm]	Anchor length l [mm]	Max. fixture thickness t_{fix} [mm]	Disc \varnothing [mm]	Sales unit [pcs]
FIF-CN II 8/60	546443	■	8	65	55	108	50	60	100
FIF-CN II 8/80	546444	■	8	65	55	128	70	60	100
FIF-CN II 8/100	546445	■	8	65	55	148	90	60	100
FIF-CN II 8/120	546446	■	8	65	55	168	110	60	100
FIF-CN II 8/140	546447	■	8	65	55	188	130	60	100
FIF-CN II 8/160	546448	■	8	65	55	208	150	60	100
FIF-CN II 8/180	546449	■	8	65	55	228	170	60	100
FIF-CN II 8/200	546450	■	8	65	55	248	190	60	100
FIF-CN II 8/220	546451	■	8	65	55	268	210	60	100
FIF-CN II 8/240	546452	■	8	65	55	288	230	60	100
FIF-CN II 8/260	546453	■	8	65	55	308	250	60	100
FIF-CN II 8/280	546454	■	8	65	55	328	270	60	100
FIF-CN II 8/300	546455	■	8	65	55	348	290	60	100
FIF-CN II 8/320	546456	■	8	65	55	368	310	60	100
FIF-CN II 8/340	546457	■	8	65	55	388	330	60	100

LOADS

Render fixing FIF-CN II 8 3)

Highest permissible loads for a single anchor^{1) 4)} for fixing of external thermal insulation composite systems with rendering.
For the design the complete assessment ETA-18/0393 has to be considered.

Base material	Brick raw density ρ [kg/dm ³]	Minimum compressive brick strength f_b [N/mm ²]	Min. embedment depth h_{nom} [mm]	Min. member thickness h_{min} [mm]	Beton und Mauerwerk ⁵⁾		
					Permissible tensile load ³⁾	Minimum spacing ²⁾	Minimum edge distance ²⁾
					N_{perm} [kN]	s_{min} [mm]	c_{min} [mm]
Concrete according to EN 206-1:2000							
FIF-CN II 8	C12/15 - C50/60		35 ⁶⁾	100	0,25	100	100
Solid clay bricks Mz according to EN 771-1:2011							
FIF-CN II 8	≥ 2,0	12	35 ⁶⁾	100	0,25	100	100
Vertically perforated clay bricks HLz according to EN 771-1:2011							
FIF-CN II 8	≥ 1,0	12	35 ⁷⁾	100	0,17	100	100
Lightweight aggregate concrete LAC according to EN 1520:2011							
FIF-CN II 8	≥ 0,8	6	55 ⁶⁾	100	0,17	100	100
Autoclaved aerated concrete blocks AAC according to EN 771-4:2011							
FIF-CN II 8	≥ 0,5	4	55 ⁷⁾	100	0,10	100	100

¹⁾ The partial safety factors for material resistance as regulated in the assessment as well as a partial safety factor for load actions of $\gamma_L = 1,5$ berücksichtigt.

²⁾ Possible minimum spacing resp. edge distance according to assessment.

³⁾ Plastic anchor for fixing of external thermal insulation composite systems with rendering according to ETAG014. Only tensile wind loads are permitted.

⁴⁾ The given loads are valid for installation and use of fixations in dry base material for temperatures in the substrate up to +24 °C (resp. short term up to +40 °C).

⁵⁾ Restrictions concerning the manufacturer and the permissible hole patterns as well as the web thickness see assessment.

⁶⁾ Drill method hammer drilling.

⁷⁾ Hammer drilling.

The economic screw fixing for all ETICS insulation materials



Screwed fixing of insulation boards

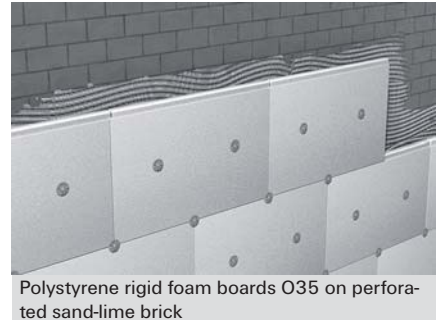

Polystyrene rigid foam boards O35 on perforated sand-lime brick

BUILDING MATERIALS

- Building material classes A, B, C, D, E
- Concrete
- Concrete (weather shell)
- Building brick
- Solid sand-lime brick
- Hollow blocks made from lightweight concrete
- Vertically perforated brick
- Perforated sand-lime brick
- Lightweight aggregate concrete
- Aerated concrete

APPROVALS



ADVANTAGES

- Compound screw minimises the thermal bridge, thus there are no fixing marks on the façade.
- Less drill wear and drill time due to minimum installation depth of 35 mm in the substrate.
- With flush installation, the disc tapers to a very thin edge, thus providing for optimal retaining of the insulation panel and for application of thin render.
- For insulation material thicknesses up to 340 mm.
- Standard embedment depth for all building materials.

APPLICATIONS

- Attachment of ETICS insulating boards on concrete and masonry
- Flush installation in all conventional insulation materials

FUNCTIONING

- The fixing is pushed through the insulation into the drilled hole and is screwed tight.
- For lengths from 250 mm, at least 180 mm long T25 bits are required. These are not included in the delivery assortment.

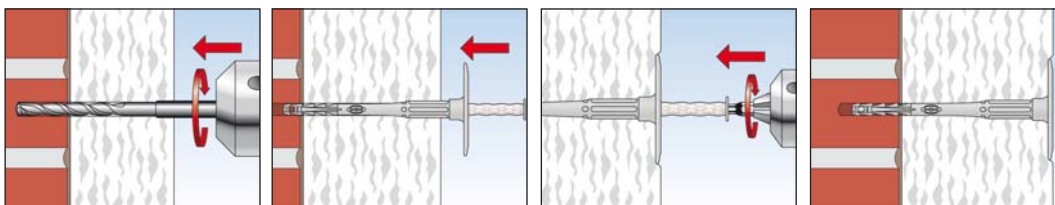

TECHNICAL DATA



Render fixing FIF-CS 8

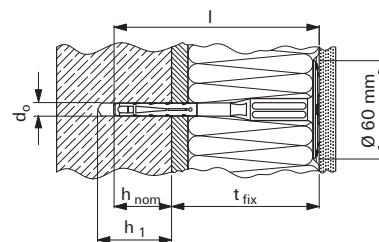

Item	Art.-No.	Approval ETA	Drill hole diameter d_0 [mm]	Min. drill hole depth h_1 [mm]	Effect. anchorage depth h_{nom} [mm]	Anchor length l [mm]	Max. fixture thickness t_{fix} [mm]	Disc Ø [mm]	Sales unit [pcs]
FIF-CS 8/60	534157	■	8	45	35	108	70	60	100
FIF-CS 8/80	534158	■	8	45	35	128	90	60	100
FIF-CS 8/100	534159	■	8	45	35	148	110	60	100
FIF-CS 8/120	534160	■	8	45	35	168	130	60	100
FIF-CS 8/140	534161	■	8	45	35	188	150	60	100
FIF-CS 8/160	534162	■	8	45	35	208	170	60	100
FIF-CS 8/180	534163	■	8	45	35	228	190	60	100
FIF-CS 8/200	534164	■	8	45	35	248	210	60	100
FIF-CS 8/220	534165	■	8	45	35	268	230	60	100
FIF-CS 8/240	534166	■	8	45	35	288	250	60	100
FIF-CS 8/260	534167	■	8	45	35	308	270	60	100
FIF-CS 8/280	534168	■	8	45	35	328	290	60	100
FIF-CS 8/300	534169	■	8	45	35	348	310	60	100
FIF-CS 8/320	534170	■	8	45	35	368	330	60	100
FIF-CS 8/340	534171	■	8	45	35	388	350	60	100

LOADS

Render fixing FIF-CS 8 ³⁾

Highest permissible loads for a single anchor¹⁾⁴⁾ for fixing of external thermal insulation composite systems with rendering.

For the design the complete assessment ETA-15/0006 has to be considered.

Base material	Brick raw density ρ [kg/dm ³]	Minimum compressive brick strength f_b [N/mm ²]	Min. embedment depth h_{nom} [mm]	Min. member thickness h_{min} [mm]	Beton und Mauerwerk ⁵⁾		
					Permissible tensile load ³⁾ N_{perm} [kN]	Minimum spacing ²⁾ s_{min} [mm]	Minimum edge distance ²⁾ c_{min} [mm]
Concrete according to EN 206-1:2000							
FIF-CS 8	C12/15 - C50/60		35 ⁶⁾	100	0,40	100	100
Solid clay bricks Mz according to EN 771-1:2011							
FIF-CS 8	≥ 1,8	20	35 ⁶⁾	100	0,40	100	100
Vertically perforated clay bricks HLz according to EN 771-1:2011							
FIF-CS 8	≥ 1,0	12	25 ⁷⁾	100	0,20	100	100
Lightweight aggregate concrete LAC according to EN 1520:2011							
FIF-CS 8	≥ 0,9	6	35 ⁶⁾	100	0,20	100	100
Autoclaved aerated concrete blocks AAC according to EN 771-4:2011							
FIF-CS 8	≥ 0,5	4	35 ⁷⁾	100	0,10	100	100

¹⁾ The partial safety factors for material resistance as regulated in the assessment as well as a partial safety factor for load actions of $\gamma_L = 1,5$ are considered.

²⁾ Possible minimum spacing resp. edge distance according to assessment.

³⁾ Plastic anchor for fixing of external thermal insulation composite systems with rendering according to ETAG014. Only tensile wind loads are permitted.

⁴⁾ The given loads are valid for installation and use of fixations in dry base material for temperatures in the substrate up to +24 °C (resp. short term up to +40 °C).

⁵⁾ Restrictions concerning the manufacturer and the permissible hole patterns as well as the web thickness see assessment.

⁶⁾ Drill method hammer drilling.

⁷⁾ Hammer drilling.

Discs for combining nail and frame fixings, as well as screws



Insulating materials in two-leaf external walls

11

Insulation fixings / Façade fixings

ADVANTAGES

- The various disc diameters allow for individual adaptation to various insulation materials and requirements and offer the greatest flexibility with wide-ranging applications.
- The flexible pins in the DT 90 ensure sustained pressure on the insulation, thus providing a secure hold.
- The DTM 60 made of stainless steel A4 makes it possible to use a frame fixing, and allows for a secure fixing of the insulation material in façade construction in cases of high requirements.

APPLICATIONS

- To fix soft and pressure-resistant insulation materials.
- DT 90/4 on VB wall tie
- DT 60/10, DTM 60/10 and DTM 70/10 in combination with 10 mm frame fixing
- DT 90/8 and insulation washer 8/60 in combination with 8 mm hammerfix
- HV and HK 36 with 5 mm screws

FUNCTIONING

- The disc size is to be selected in line with the compressive strength of the insulating material.
- To be combined with anchors, screws or nails corresponding to the available base material.
- DT 90/4 is suitable for pushing on to fischer wall tie VB.

TECHNICAL DATA



HV 36 plastic

HV 36 zinc

ISO-disk 8/60

DT 60/10

DTM-A4

DTM 70/10

DT 90

Item	Art.-No.	Disc Ø	Disc height	Through hole	Steel sheet thickness	Sales unit
		[mm]	[mm]	d_f [mm]	s [mm]	[pcs]
HK 36 plastic	004283	36	4.5	5	–	100
HV 36 zinc	004286	36	3.5	5	0,7	100
ISO-disk 8/60	001680	60	7	8	–	100
DT 60/10	044317	60	7	10	–	50
DTM 60/10 A4	088805	60	3	10,5	0,5	100
DTM 70/10 zinc	044318	70	3	10,5	–	50
DT 90/4	080957 ¹⁾	90	9.3	4	–	250
DT 90/8	080958	90	9.3	8,2	–	250

1) The central hole is adapted in such a way that the disc clamps well on the 4 mm wire of the VB walltie.

The installation-friendly polyamide retaining disc for panel building materials

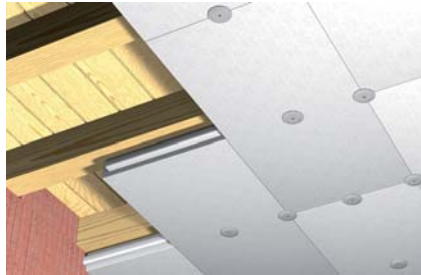

Pressure-resistant insulation boards on timber constructions



Pressure-resistant insulation boards on timber constructions

BUILDING MATERIALS

- Wood and wooden materials
- Sheet thickness up to 0.8 mm

CERTIFICATES



ADVANTAGES

- The DHT-S screw allows setting without pre-drilling, thus saving a stage of installation.
- The plug reduces the heat transmission and prevents marks on the plaster surface.
- The extremely thin disc construction allows for use with thin layers of plaster and reinforcements and offers maximum flexibility.

APPLICATIONS

To fix pressure-resistant insulating materials in plaster façades, such as:

- Polystyrene
- PU panels
- Light building boards made of wood wool
- Cork boards / coir matting

FUNCTIONING

- Non-bearing layers, such as adhesive, are to be included in the useful length.
- The retaining disc with screw is set in push-through installation with a cordless screwdriver.
- A PH2 bit is required for installation.
- After installation, seal the screw hole with the enclosed plug.

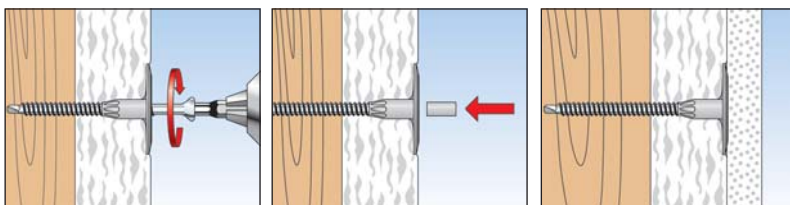

TECHNICAL DATA



DHT 50/ ... disc



Retaining disc with screw DHT S

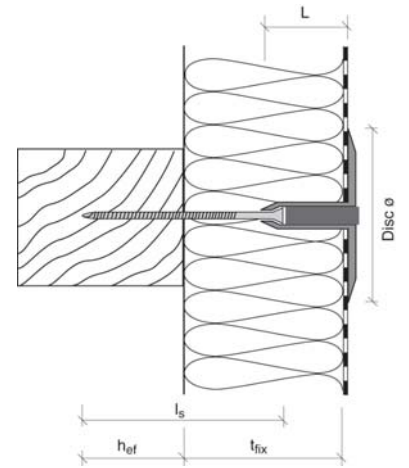

Item	Art.-No.	Colour	Usable length t_{fix} [mm]	Shaft length L [mm]	Screw length l_s [mm]	Effect. anchorage depth h_{ef} [mm]	Disc Ø [mm]	Sales unit [pcs]
DHT 50/20 W	044490	white	–	20	–	–	50	500
DHT 50/40 W	044491	white	–	40	–	–	50	500
DHT S 30 W	044390	white	30	20	45	25	50	500
DHT S 50 W	044392	white	40 - 50	20	65	25	50	500
DHT S 70 W	044394	white	60 - 70	40	65	25	50	500
DHT S 80 W	044395	white	70 - 80	40	75	25	50	500
DHT S 100 W	044388	white	90 - 105	40	100	25	50	500
DHT S 120 W	044389	white	110 - 125	40	120	25	50	500
DHT S 150 W	516154	white	140 - 155	40	150	25	50	500

Thermal bridge-free installation in insulation materials

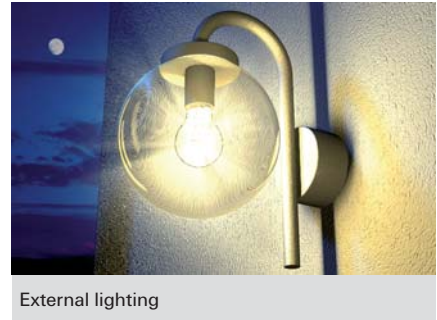

BUILDING MATERIALS

- Non-plastered, pressure-resistant insulating boards
- Plastered, pressure-resistant insulating boards
- ETICS insulating boards

ADVANTAGES

- Since the anchor is set exclusively in the insulation itself, fixtures can be installed without thermal bridges.
- The geometry of the FID allows for a simple installation in thin layers of plaster, without the need for pre-drilling, thus saving a stage of installation.
- The FID 50 is used in thin insulating boards from 50mm. The FID 90 is used in thicker insulating boards, and can bear higher loads.
- The bit mounting allows for setting with standard tools, thus allowing for a fast and economic installation.

APPLICATIONS

To fix lightweight fixtures in plastered and non-plastered insulating boards made of polystyrene and polyurethane.

The areas of application are:

- Façade construction (ETICS)
- Insulating construction
- Electric construction
- Refrigerated and climate construction
- Acoustic construction

FUNCTIONING

- The FID can be set in the insulating board with a cordless screwdriver or by hand.
- The special spiral thread taps itself in the insulating board.
- Fixtures are fixed with a 4.5 mm screw for the FID 50, and with a 6 mm screw for the FID 90.
- Water ingress in the insulation can be prevented by sealing the plug collar with a suitable sealant after successful pre-positioned installation.
- We recommend to predrill an 6 mm hole in ETICs rendering.

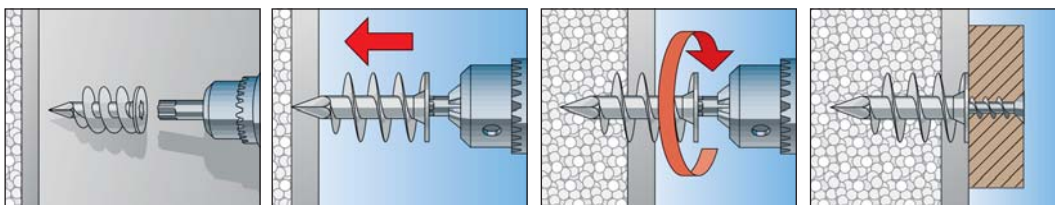

TECHNICAL DATA

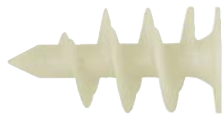

Insulation fixing **FID 50**



Insulation fixing **FID 90**

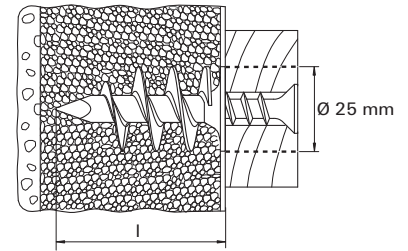

Item	Art.-No.	Anchor length l [mm]	Min. bolt penetration [mm]	Wood and chipboard screws d _s [mm]	Drive	Sales unit [pcs]
FID 50	048213	50	50	4,5 - 5	T40	50
FID 90	510971	90	90	6	6 mm / 6-kt	25

LOADS

Insulation fixing FID

Highest recommended loads¹⁾ for a single anchor.

The given loads are valid for chipboard screws with maximum diameter.

Type		FID 50	FID 90
Screw diameter	Ø [mm]	4,5 - 5,0	6,0
Recommended loads in the respective base material N_{rec}²⁾			
Polystyrene	PS 15 [kN]	0,07	0,17
Polystyrene	PS 20 [kN]	0,10	0,20

¹⁾ Required safety factors are considered.

²⁾ Valid for tensile load.

Thermal bridge-free installation in insulation materials



External lighting



Letterbox

BUILDING MATERIALS

- Non-plastered, pressure-resistant insulating boards
- Plastered, pressure-resistant insulating boards
- ETICS insulating boards

CERTIFICATES



ADVANTAGES

- Produced with at least 50% renewable raw materials and therefore particularly environmentally friendly.
- Just as effective, secure and durable as regular FID plugs. To fix lightweight fixtures in plastered and non-plastered insulating boards.
- Thermal bridge-free mounting when exclusively set in insulation material.
- Installation without pre-drilling even through thin plaster layers, thus saving a work step.
- Easy to set using a standard bit.

APPLICATIONS

To fix lightweight fixtures in plastered and non-plastered insulating boards made of polystyrene and polyurethane.

The areas of application are:

- Façade construction (ETICS)
- Insulating construction
- Electric construction
- Refrigerated and climate construction
- Acoustic construction

FUNCTIONING

- The FID GREEN can be set in pre-positioned installation with a cordless screwdriver or by hand.
- With its strong drill tip, the insulation fixing FID GREEN breaks through thin plaster layers and cuts a positive fit into the insulation panel with its specially shaped spiral thread.
- From a plaster thickness of 5 mm, we recommend to create a 6 mm hole. This serves for better guidance of the fastener in the setting process.
- Water ingress in the insulation material can be prevented by sealing the plug collar after successful installation.
- Attachment parts can be easily attached with screws.
- We recommend to predrill an 6 mm hole in ETICS rendering.

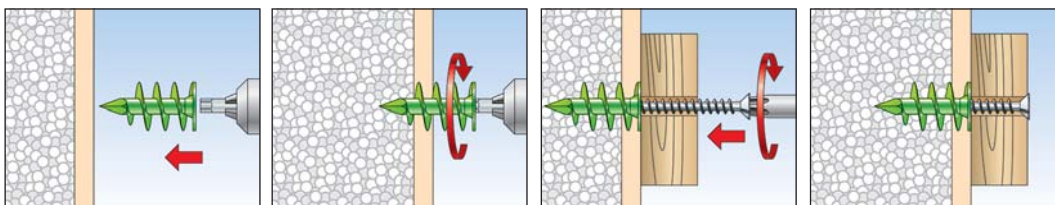

TECHNICAL DATA



Insulation fixing **FID GREEN 50**



Insulation fixing **FID GREEN 90**

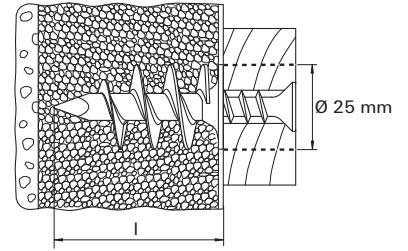

Item	Art.-No.	Anchor length l [mm]	Min. bolt penetration [mm]	Wood and chipboard screws d _s [mm]	Drive	Sales unit [pcs]
FID GREEN 50	524851	50	50	4,5 - 5	T40	45
FID GREEN 90	524852	90	90	6	Inbus 6 mm	20

LOADS

Insulation fixing FID GREEN

Highest recommended loads¹⁾ for a single anchor.

The given loads are valid for chipboard screws with maximum diameter.

Type		FID GREEN 50	FID GREEN 90
Screw diameter	Ø [mm]	4,5 - 5,0	6,0
Recommended loads in the respective base material N_{rec}²⁾			
Polystyrene	PS 15 [kN]	0,07	0,17
Polystyrene	PS 20 [kN]	0,10	0,20

¹⁾ Required safety factors are considered.

²⁾ Valid for tensile load.

The installation-friendly insulation clamp



BUILDING MATERIALS

- Wooden materials
- Wooden panel materials

ADVANTAGES

- The holding clamp DVN allows for a hidden installation for a homogeneous surface.
- The complete fixing system, comprising the clamp and zinc-plated nails, allows for an immediate installation in line with building requirements.
- The Sendzimir-galvanised steel claw allows for durable use for the secure anchoring of pressure-resistant insulation materials.

APPLICATIONS

- To fix pressure-resistant insulation materials (e.g. polystyrene, PU panels, glass foam boards) onto timber sub-structures, predominantly in the ceiling area

FUNCTIONING

- The holding clamp is fixed with the supplied nails on the wooden substrate with a hammer.
- The points of the holding clamp DVN are pushed into the slot side of the insulating board until it is held securely.

TECHNICAL DATA



Clamp DVN

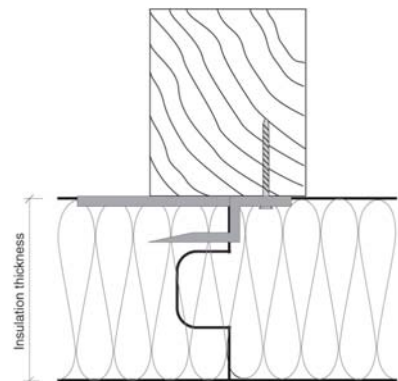

Item	Art.-No.	For insulation thickness		Sales unit
		[mm]		
DVN 15	047240	up to 60		250
DVN 30	047243	from 80		250

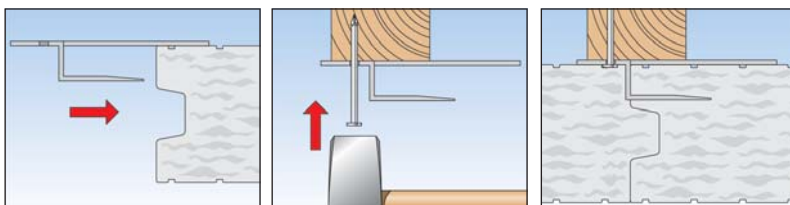

The pre-assembled fibre cement panel screw



Corrugated root tiles made of fibre cement

BUILDING MATERIALS

- Wood
- Wooden panel materials

ADVANTAGES

- The screw is pre-fitted with a seal washer. This provides a complete fixing set for a simple installation.
- The screw is protected against corrosion and thus withstands the stresses of weather when used outside.

APPLICATIONS

- For fixing of:**
- Fibre cement panels
 - Undulating roof tiles

FUNCTIONING

- The screw is set in push-through installation using a cordless screwdriver. No pre-drilling of the fibre cement panel is required.

TECHNICAL DATA



Fibre cement panel screw **FAFZ H**

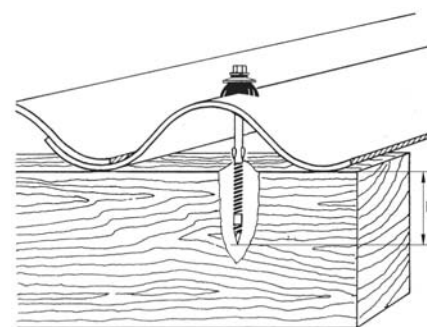



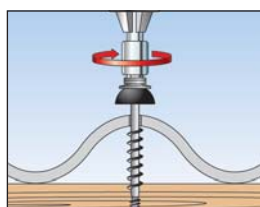





























Item	Art.-No.	Diameter x length	Min. bolt penetration	Sales unit
		[mm]	[mm]	[pcs]
FAFZ-H 6,5 x 130 DS 25	092210	6,5 x 130	50	100





12 Foams, sealants

	Page		Page
One-component gun foam PUP S 750	 502	Premium silicone for natural stone DNS	 522
One-component premium gun foam PUP 750	 503	Premium B1 silicone DFS	 523
One-component maxi gun foam PUP S 500	 504	Construction sealant Premium DKM	 524
One-component premium gun foam compact PUP 500	 505	Façade acrylic Premium DFA	 525
One-component premium gun foam PUP 750 B3	 506	Premium painting acrylic DMA	 526
One-component premium gun foam PUP BS 750	 507	Premium structured acrylic DSA	 527
One-component premium B1 gun foam PUP B1 750	 508	Acrylic sealant DA	 528
One-component premium adhesive foam PUP ETICS 750	 509	Repair mortar DEC	 529
One-component premium perimeter adhesive foam PUP P 750	 510	Premium all-weather sealant DDK	 530
One-component rapid installation foam PU S 500/750	 511	Roof sealing compound DD	 531
One-component premium rapid installation foam PU 500/750	 512	Accessories for sealants	 532
2-component premium rapid foam 2K PU 400	 513	Sealant selection matrix	534
Accessories	 514	Zinc spray FTC-ZS	 536
Premium sanitary silicone DSSA	 516	Zinc spray bright grade FTC-ZB	 537
Sanitary silicone DSSI	 517	Zinc-alu spray FTC-ZA	 538
Multi-silicone DMS	 518		
Premium high temperature silicone DHS	 519		
Premium construction silicone DBSA	 520		
Roof and wall silicone DBSI	 521		

The gun foam with proven joint sound-proofing, thermal insulation and water pressure resistance for professionals



Window connection joints

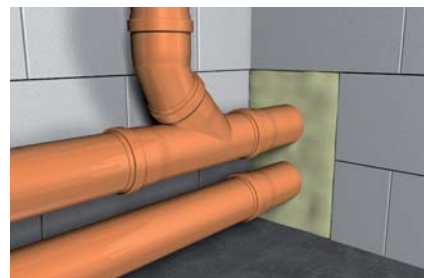

Filling pipe penetrations

BUILDING MATERIALS

Bonds to all standard building materials such as:

- Concrete
- Anodised layer
- Fibre cement
- Gypsum plasterboard
- Wood
- Sand-lime brick
- Plastics (not on PE, PP, Teflon, silicone)
- Masonry
- Metals with priming coat
- Plaster
- Stone

CERTIFICATES

- General test certificate from building authorities P-NDS04-137 for B2
- Proven joint soundproofing $R(ST,w)=61 (-1;-3)$ dB in line with ISO EN 717-1
- Proven thermal conductivity: Reduces heat loss at $0.0345 \text{ W} / (\text{m} \cdot \text{K})$
- Based on DIN 18542 proven air tightness of $a < 0,1 \text{ m}^3 / [\text{h} \cdot \text{m}^2 (\text{daPa})^2 / 3]$
- Test for watertightness for the adhesion of manhole rings
- French VOC-emission class A+

ADVANTAGES

- The proven 61 dB sound insulation fulfills the standards of modern sound insulation and helps to reduce noise.
- The thermal protection and proven airtightness allows compliance with energy saving according to EnEV and substantiated as effective reduction of heat loss.
- External testing of watertightness when used in connection with hinged manhole rings fulfils the requirements for a well foam.
- The low level foam expansion during the curing period avoids reworking, thus guaranteeing a simple and time-saving application.
- The new non-sticking safety valve guarantees long-lasting functionality.

APPLICATIONS

- Insulating and filling window connection joints, around window sills and shutter boxes
- To insulate and fill wall penetrations, cavities, wall connections and finished elements
- To seal and bind well shafts, manhole shafts, domestic sewage treatment plants and cisterns

FUNCTIONING

- 1-component PU foam
- Building material class B2
- Processing temperature environment: $+10 \text{ }^\circ\text{C}$ to $+30 \text{ }^\circ\text{C}$ (can temperature: $+5 \text{ }^\circ\text{C}$ to $+30 \text{ }^\circ\text{C}$)
- Non-tacky after approx. 15 minutes
- Hardened after approx. 24 hours
- Temperature resistant from $-40 \text{ }^\circ\text{C}$ to $+90 \text{ }^\circ\text{C}$
- Layer thicknesses $> 50 \text{ mm}$ foam in several layers and then dampen.
- Fresh foam stains can be removed immediately with fischer PU cleaner.

TECHNICAL DATA

Item	Art.-No.	Content per can	Max. foam yield (free foaming)	Colour	Sales unit
		[ml]	[l]		[pcs]
PUP S 750 (DE)	539197 ¹⁾	750	45	beige	12
PUP S 750 B2	040302	750	45	beige	12

1) Without protective gloves, for commercial users only.

The gun foam with proven sound and thermal insulation as well as increased foam yield



Window connection joints



Connection joints around shutter boxes

BUILDING MATERIALS

Bonds to all standard building materials such as:

- Concrete
- Anodised layer
- Gypsum plasterboard
- Wood
- Sand-lime brick
- Plastics (not on PE, PP, Teflon, silicone)
- Masonry
- Metals with priming coat
- Plaster

CERTIFICATES

- General test certificate from building authorities P-NDS04-137
- Proven joint soundproofing $R(ST,w)=61 (-1;-3)$ dB in line with ISO EN 717-1
- Proven thermal conductivity: Reduces heat loss by 0.0345 W/(m²K)
- Based on DIN 18542, proven airtightness of $a < 0.1$ m³/[h*m²(daPa)^{2/3}]
- French VOC-emission class A+

ADVANTAGES

- The thermal protection and proven reduction of air permeability fulfil the high standards for modern thermal protection.
- The proven 6 dB sound insulation fulfils the standards of modern sound insulation and helps to reduce noise.
- The high yield of up to 55 l reduces the number of cans needed, thus ensuring maximum economic efficiency.
- The low level of foam expansion during the curing period avoids reworking, thus guaranteeing a simple and time-saving application.
- The new safety valve prevents adhesion when being stored horizontally or during long interruptions of work, thus guaranteeing long-lasting functionality.

APPLICATIONS

- Insulating and filling window connection joints, around window sills and shutter boxes
- Insulating and filling in roofing work and dry construction
- Insulating and filling finished elements, wall connections, wall penetrations and cavities
- Insulating and filling pipe penetrations and ventilation ducts

FUNCTIONING

- 1-component PU foam
- Building material class B2
- Processing temperature environment: +5 °C to +35 °C (can temperature: +5 °C to +30 °C)
- Non-tacky after approx. 25 minutes
- Can be cut after approx. 1 hour
- Hardened after approx. 24 hours
- Temperature resistant from -40 °C to +90 °C
- Layer thicknesses > 50 mm: foam in several layers and then dampen.
- Fresh foam stains can be removed immediately with fischer PU cleaner.

TECHNICAL DATA

Item	Art.-No.	Content per can [ml]	Max. foam yield (free foaming) [l]	Colour	Sales unit [pcs]
PUP 750 (DE)	053084	825	55	beige	12

The proven sound and thermal insulation foam with higher foam yield for professionals in a short can



Window connection joints



Closing joints in structural work

BUILDING MATERIALS

Bonds to all standard building materials such as:

- Concrete
- Anodised layer
- Gypsum plasterboard
- Wood
- Sand-lime brick
- Plastics (not on PE, PP, Teflon, silicone)
- Masonry
- Metals with priming coat
- Plaster

CERTIFICATES

- General test certificate from building authorities P-NDS04-137 für B2
- Proven joint soundproofing: $R(ST,w)=61 (-1;-3)$ dB in line with ISO EN 717-1
- Proven thermal conductivity: Reduces heat loss at $0.0345 \text{ W}/(\text{m} \cdot \text{K})$
- Based on DIN 18542 proven airtightness of $a < 0,1 \text{ m}^3/[\text{h} \cdot \text{m}^2(\text{daPa})^{2/3}]$
- French VOC-emission class A+

ADVANTAGES

- The short, handy can allows the correct positioning in awkward places and leads without premature gas loss to a high emptying of residues.
- The low level of foam expansion during the curing period avoids reworking, thus guaranteeing a simple and time-saving application.
- The thermal protection and proven airtightness allows compliance with energy saving according to EnEV and substantiated as effective reduction of heat loss.
- The high joint soundproofing of 61 dB fulfils the standards of modern sound insulation and helps to reduce noise.

APPLICATIONS

- Insulating and filling window connection joints, around window sills and shutter boxes
- Insulating and filling finished elements, wall connections, wall penetrations and cavities
- Insulating and filling in roofing work and dry construction (e.g. in the ceiling area)
- Insulating and filling pipe penetrations and ventilation ducts

FUNCTIONING

- 1-component PU foam
- Building material class B2
- Low post-expansion
- Processing temperature environment: $\pm 0 \text{ }^\circ\text{C}$ to $+35 \text{ }^\circ\text{C}$ (can temperature: $+5 \text{ }^\circ\text{C}$ to $+20 \text{ }^\circ\text{C}$)
- Non-tacky after approx. 8 minutes
- Can be cut after approx. 20 minutes
- Temperature resistant from $-40 \text{ }^\circ\text{C}$ to $+90 \text{ }^\circ\text{C}$
- Fresh foam stains can be removed immediately with fischer PU cleaner.

TECHNICAL DATA

Item	Art.-No.	Content per can [ml]	Max. foam yield (free foaming) [l]	Colour	Sales unit [pcs]
PUP S 500 (DE)	539163	500	43	beige	12

1) Without protective gloves, for commercial users only.

The grey gun foam in the compact can with high foam yield



Window connection joints



Closing joints in structural work

BUILDING MATERIALS

Bonds to all standard building materials such as:

- Concrete
- Anodised layer
- Gypsum plasterboard
- Wood
- Sand-lime brick
- Plastics (not on PE, PP, Teflon, silicone)
- Masonry
- Metals with priming coat
- Plaster

CERTIFICATES

- General test certificate from building authorities P-NDS04-137
- Proven joint soundproofing $R(ST,w)=61 (-1;-3)$ dB in line with ISO EN 717-1
- Proven thermal conductivity: Reduces heat loss by $0.0345 \text{ W}/(\text{m}^2\text{K})$
- Based on DIN 18542, proven airtightness of $a < 0.1 \text{ m}^3/[\text{h}^* \text{m}^2 (\text{daPa})^{2/3}]$

ADVANTAGES

- The compact, handy can allows for use in difficult to access areas, and achieves a high degree of emptying without premature loss of gas.
- The grey colour of the foam is ideally suited to concrete substrates and allows for an inconspicuous filling of joints.
- The proven thermal protection and reduction of air permeability fulfil the high standards for modern thermal protection.
- The proven 6 dB sound insulation fulfils the standards of modern sound insulation and helps to reduce noise.
- The new safety valve prevents adhesion when being stored horizontally or during long interruptions of work, thus guaranteeing long-lasting functionality.

APPLICATIONS

- Insulating and filling component joints, wall connections and wall penetrations
- Insulating and filling in roofing work and dry construction (e.g. in the ceiling area)
- Insulating and filling window connection joints, around window sills and shutter boxes
- Insulating and filling pipe penetrations and ventilation ducts

FUNCTIONING

- 1-component PU foam
- Building material class B2
- Processing temperature environment: of $-5 \text{ }^\circ\text{C}$ to $+35 \text{ }^\circ\text{C}$ (can temperature: $+5 \text{ }^\circ\text{C}$ to $+20 \text{ }^\circ\text{C}$)
- Non-tacky after approx. 8 minutes
- Can be cut after approx. 20 minutes
- Cures within 5 to 8 hours
- Temperature resistant from $-40 \text{ }^\circ\text{C}$ to $+90 \text{ }^\circ\text{C}$
- Layer thicknesses $> 50 \text{ mm}$: foam in several layers and then dampen.
- Fresh foam stains can be removed immediately with fischer PU cleaner.

TECHNICAL DATA

Item	Art.-No.	Content per can [ml]	Max. foam yield (free foaming) [l]	Colour	Sales unit [pcs]
PUP 500 (DE)	503259	500	43	concrete grey	12

The gun foam with the perfect dosage



Window connection joints



Connection joints around shutter boxes

BUILDING MATERIALS

Bonds to all standard building materials such as:

- Concrete
- Anodised layer
- Gypsum plasterboard
- Wood
- Sand-lime brick
- Plastics (not on PE, PP, Teflon, silicone)
- Masonry
- Metals with priming coat
- Plaster

CERTIFICATES

- Proven joint soundproofing
R(ST,w)=60 (-1;-4) dB in line with ISO EN 717-1

ADVANTAGES

- The low level of foam expansion during the curing period avoids reworking, thus guaranteeing a simple and time-saving application.
- The easy dosage allows for a controlled filling and sealing, and ensures that the correct amount is used.
- The proven 60dB sound insulation fulfils the standards of modern sound insulation and helps to reduce noise.
- The new non-sticking safety valve guarantees long-lasting functionality.

APPLICATIONS

- Insulating and filling window connection joints, around window sills and shutter boxes
- Insulating and filling in roofing work and dry construction
- Insulating and filling finished elements, wall connections, wall penetrations and cavities
- Insulating and filling pipe penetrations and ventilation ducts

FUNCTIONING

- 1-component PU foam
- Building material class B3
- Processing temperature environment: +5 °C to +35 °C (can temperature: +10 °C to +30 °C)
- Non-tacky after approx. 15 minutes
- Can be cut after approx. 45 minutes
- Cures within 5 to 8 hours
- Temperature resistant from -40 °C to +90 °C
- Layer thicknesses > 50 mm: foam in several layers and then dampen.
- Fresh foam stains can be removed immediately with fischer PU cleaner.

TECHNICAL DATA

Item	Art.-No.	Content per can	Max. foam yield (free foaming)	Colour	Sales unit
		[ml]	[l]		[pcs]
PUP 750 B3 (EN)	058501	750	41	beige	12
PUP 750 B3 GunGrade (EN/FR)	098012	750	41	beige	12

The gun foam with proven resistance to water pressure



Sealing concrete manhole rings

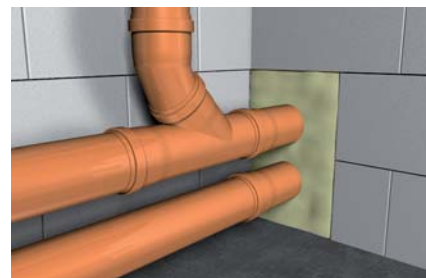

Filling pipe penetrations

BUILDING MATERIALS

Bonds to all standard building materials such as:

- Concrete
- Anodised layer
- Fibre cement
- Gypsum plasterboard
- Wood
- Sand-lime brick
- Plastics (not on PE, PP, Teflon, silicone)
- Masonry
- Metals with priming coat
- Plaster
- Stone

CERTIFICATES

- General test certificate from building authorities P-NDS04-137
- Test for watertightness up to 0.5 bar for the adhesion of manhole rings
- Proven joint soundproofing: $R(ST,w)=61 (-1;-3)$ dB in line with ISO EN 717-1
- Proven thermal conductivity: Reduces heat loss by $0.0345 W/(m^*K)$
- Based on DIN 18542, proven airtightness of $a < 0.1 m^3/[h^*m^*(daPa)^{2/3}]$
- French VOC-emission class A+

ADVANTAGES

- External testing of watertightness when used in connection with hinged manhole rings fulfils the requirements for a well foam.
- The special foam is ready and easy to use, and replaces the time- and work-intensive application of mortar.
- The high resistance to dilute chemicals and mineral oil, the resistance to acids and bacteria found in soil, and the resistance to rot all guarantee a lasting function.
- The easy dosage allows for a controlled filling and sealing, and ensures that the correct amount is used.
- The new non-sticking safety valve guarantees long-lasting functionality.

APPLICATIONS

- To quickly fill joints between hinged manhole rings
- To seal and bind well shafts, manhole shafts, domestic sewage treatment plants and cisterns
- To insulate and fill wall penetrations, cavities, wall connections and finished elements

FUNCTIONING

- 1-component PU foam
- Building material class B2
- Processing temperature environment: $+10\text{ °C}$ to $+30\text{ °C}$ (can temperature: $+5\text{ °C}$ to $+30\text{ °C}$)
- Non-tacky within approx. 15 minutes
- Bind manholes together before skin formation.
- Do not cut or spread foam coming from the hinge.
- Hardened after approx. 24 hours
- Temperature resistant from -40 °C to $+90\text{ °C}$
- Layer thicknesses $> 50\text{ mm}$ foam in several layers and then dampen.
- Fresh foam stains can be removed immediately with fischer PU cleaner.

TECHNICAL DATA

Item	Art.-No.	Content per can	Max. foam yield (free foaming)	Colour	Sales unit
		[ml]	[l]		[pcs]
PUP BS 750 B2 (DE/EN)	513763	750	45	beige	12

The hardly flammable B1 gun foam



Filling cavities in the insulation



Foaming steel door frames

BUILDING MATERIALS

Bonds to all standard building materials such as:

- Concrete
- Anodised layer
- Gypsum plasterboard
- Wood
- Sand-lime brick
- Plastics (not on PE, PP, Teflon, silicone)
- Masonry
- Metals with priming coat
- Plaster

CERTIFICATES

- General test certificate from building authorities P-NDS04-620
- Proven joint soundproofing: of 10 and 20 mm joint width: $R_{s,w} (C; Ctr) \geq 63 (-2;-5) \text{ dB}$
- French VOC-emission class A+

ADVANTAGES

- The PUPS is hardly flammable in line with the B1 test and can therefore be used between solid, mineral or metal building materials. Thus it provides the highest level of safety.
- The new high-quality safety valve prevents adhesion when being stored horizontally or during long interruptions of work, thus guaranteeing long-lasting functionality.
- The easy dosage allows for a controlled filling and sealing, and ensures that the correct amount is used.

APPLICATIONS

- High-efficiency thermal insulation on façades
- Insulating and filling in roofing work
- Insulating and filling window connection joints, around window sills and shutter boxes
- Insulating and filling finished elements, wall connections, wall penetrations and cavities

FUNCTIONING

- 1-component PU foam
- Building material class B1
- Foam yield of extruded foam 45 l
- Processing temperature environment: +10 °C to +25 °C (can temperature: +10 °C to +25 °C)
- Non-tacky after approx. 10 minutes
- Can be cut after approx. 40 minutes
- Cures within 5 to 8 hours
- Temperature resistant from -40 °C to +90 °C
- Layer thicknesses > 50 mm: foam in several layers and then dampen.
- Fresh foam stains can be removed immediately with fischer PU cleaner.

TECHNICAL DATA

Item	Art.-No.	Content per can [ml]	Max. foam yield (free foaming) [l]	Colour	Sales unit [pcs]
PUP B1 750 (DE/EN)	045300	750	45	concrete grey	12

The adhesive foam for ETIC systems with general technical approval

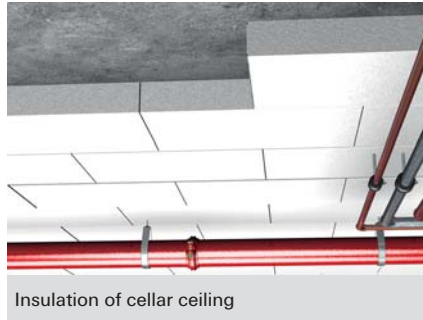

BUILDING MATERIALS

- EPS-insulation panels
- Concrete
- Bitumen coatings
- Anodised layer
- Gypsum plasterboard
- Wood
- Cold bitumen sheeting
- Plastics (not on PE, PP, Teflon, silicone)
- Masonry
- Metals with priming coat
- Plaster

CERTIFICATES

- Building approval for bonding EPS boards in ETIC systems
- Adhesive tensile strength values (based on ETAG guideline 004/2013, section 5.1.4.1.2)
- French VOC-emission class A+

ADVANTAGES

- The special recipe guarantees high adhesive tensile strength for secure fixing.
- The high foam yield allows for the bonding of up to 12 m² of wall space and is therefore especially economical.
- Really low post-expansion avoids the formation of cavities between the wall and insulation panel and guarantees a secure connection.
- The use of the can/gun system provides a time saving of approx. 30% and thus guarantees efficient work.
- The new non-sticking safety valve guarantees long-lasting functionality.

APPLICATIONS

- Bonding of EPS rigid foam panels in accordance with ETAG Guideline 004/2013
- Fixing of external wall insulation, internal wall insulation and attic insulation
- Fixing of basement ceiling insulation
- Bonding of perimeter insulation panels

FUNCTIONING

- 1-component PU foam
- Foam yield sufficient for up to 12 m² wall area
- Processing temperature environment: +5 °C to +25 °C (can temperature: +10 °C to +25 °C)
- Open Time approx. 10 minutes
- Can be cut after approx. 20 minutes
- Temperature resistant from -40 °C to +90 °C
- Extremely high heat insulation properties
- Shear resistance (EN 12090) 38,7 kPa
- Fresh foam stains can be removed immediately with fischer PU cleaner.
- When pressed on, an adhesive surface percentage of at least 40% must be achieved.
- Do not knock the insulation panels against the wall (this damages the foam structure).

TECHNICAL DATA

Item	Art.-No.	Content per can		Max. foam yield		Colour	Sales unit	
		[ml]		[m ²]			[pcs]	
PUP WDVS 750 (DE)	539164	750		up to 12		light green		12
PUP 750 ETICS (EN)	543448	750		up to 12		light green		12

The economic adhesive foam for perimeter insulation boards

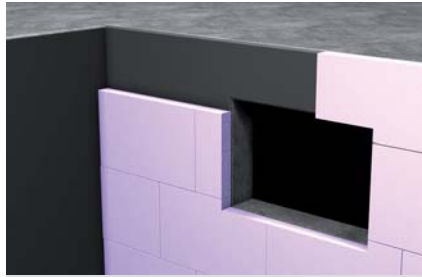

Bonding perimeter insulation boards

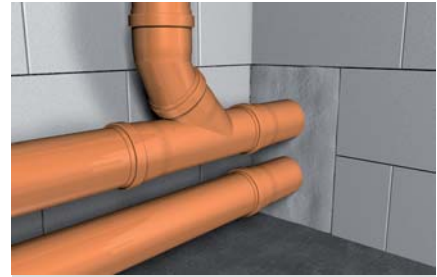

Filling pipe penetrations

BUILDING MATERIALS

- Concrete
- Bitumen coatings
- Anodised layer
- Gypsum plasterboard
- Wood
- Cold bitumen sheeting
- Plastics (not on PE, PP, Teflon, silicone)
- Masonry
- Metals with priming coat
- Plaster

CERTIFICATES

- General test certificate from building authorities P-NDS04-772
- French VOC-emission class A+

ADVANTAGES

- The high foam yield allows for the bonding of approx. 13 m² of wall space, and is therefore especially economical.
- The use of the can/gun system provides a time saving of approx. 30% and thus guarantees efficient work.
- The special PU foam formulation ensures the best adhesion to concrete and bituminous substrates, and allows for the long-term fixing of insulation boards.
- The very low level of post-expansion avoids the formation of cavities and guarantees a long-lasting insulation.
- The new non-sticking safety valve guarantees long-lasting functionality.

APPLICATIONS

- Bonding expanded polystyrene panels
- Insulating and filling wall penetrations
- Foaming in electrical installations
- Filling joints and cavities in all internal constructions
- Fixing and sealing walls and ceilings

FUNCTIONING

- 1-component PU foam
- Building material class B2
- Processing temperature environment: +10 °C to +25 °C (can temperature: +5 °C to +25 °C)
- Non-tacky after approx. 10 minutes
- Can be cut after approx. 40 minutes
- Temperature resistant from -40 °C to +90 °C
- Low heat conductivity
- Apply a min. of 3 end-to-end stripes per board, vertically from bottom to top on the external wall (spacing approx. 30 cm). The bottom board should be on fixed ground as protection from later slipping. After approx. 10 minutes apply the boards onto the holding surface and press hard.
- Fresh foam stains can be removed immediately with fischer PU cleaner.

TECHNICAL DATA

		Content per can	Max. foam yield (free foaming)	Colour	Sales unit
Item	Art.-No.	[ml]	[l]		[pcs]
PUP P 750 (DE)	506671	750	45	concrete grey	12

The high-quality rapid installation foam with proven sound insulation and resistance of water pressure for professionals



Window connection joints



Sealing concrete manhole rings

BUILDING MATERIALS

Bonds to all standard building materials such as:

- Concrete
- Anodised layer
- Gypsum plasterboard
- Wood
- Sand-lime brick
- Plastics (not on PE, PP, Teflon, silicone)
- Masonry
- Metals with priming coat
- Plaster

CERTIFICATES

- General test certificate from building authorities P-NDS04-136 for B2
- Proven joint soundproofing for B2: $R(ST,w) \geq 63$ (-1; -4) dB according ISO 10140-1
- Test for watertightness for the adhesion of manhole rings
- French VOC-emission class A+

ADVANTAGES

- The proven 63 dB sound insulation fulfills the modern sound insulation and helps to reduce noise.
- The adapter foam has been approved as watertight by an external inspection and is thus suitable for use in wet conditions. It fulfils the requirements of a well foam.
- The fast screwed adapter allows immediate use and is thus uncomplicated to use without need for additional processing equipment.
- The new non-sticking safety valve guarantees long-lasting functionality.

APPLICATIONS

- Insulating and filling window connection joints, around window sills and shutter boxes
- Bonding and sealing manhole rings
- Insulating and filling in roofing work and dry construction
- Insulating and filling finished elements, wall connections, wall penetrations and cavities

FUNCTIONING

- 1-component PU foam
- Building material class B2
- Processing temperature environment: +5 °C to +30 °C (can temperature: +5 °C to +25 °C)
- Non-tacky after approx. 15 minutes
- Can be cut after approx. 45 minutes
- Hardened after approx. 24 hours
- Temperature resistant from -40 °C to +90 °C
- Layer thicknesses > 50 mm: foam in several layers and then dampen.
- Fresh foam stains can be removed immediately with fischer PU cleaner.

TECHNICAL DATA

Item	Art.-No.	Content per can [ml]	Max. foam yield (free foaming) [l]	Colour	Sales unit [pcs]
PU S 750 (DE)	040301 1)	750	45	beige	12
PU S 1/500 B2 (DE)	040300	500	30	beige	12

1) Without protective gloves, for commercial users only.

The high-quality installation foam with reusable fix adapter system



BUILDING MATERIALS

Bonds to all standard building materials such as:

- Concrete
- Anodised layer
- Gypsum plasterboard
- Wood
- Sand-lime brick
- Plastics (not on PE, PP, Teflon, silicone)
- Masonry
- Metals with priming coat
- Plaster

CERTIFICATES

- General test certificate from building authorities P-NDS04-136 for B2
- Proven joint soundproofing: $R(ST,w)=61$ (-1; -3) dB in line with ISO EN 717-1
- Test for watertightness for the adhesion of manhole rings

ADVANTAGES

- The reclosable fix adapter allows for immediate use and for the reuse of opened cans, thus guaranteeing long-lasting functionality.
- The used solid valve prevents adhesion when being stored horizontally and premature gas loss.
- The rapid installation foam has been approved as watertight by an external inspection and is thus suitable for use in wet conditions. It fulfils the requirements of a well foam.
- The ergonomic handle sits perfectly in the hand and allows for easy use.

APPLICATIONS

- Bonding and sealing manhole rings
- Insulating and filling in roofing work and dry construction
- Insulating and filling window connection joints, around window sills and shutter boxes
- Insulating and filling finished elements, wall connections and wall penetrations

FUNCTIONING

- 1-component PU foam
- Building material class B2 or B3
- Processing temperature environment: +5 °C to +35 °C (can temperature: +5 °C to +25 °C)
- Non-tacky after approx. 20 minutes
- Can be cut after approx. 40 minutes
- Cures within 5 to 8 hours
- Temperature resistant from -40 °C to +90 °C
- Layer thicknesses > 50 mm: foam in several layers and then dampen.
- Fresh foam stains can be removed immediately with fischer PU cleaner.

TECHNICAL DATA

Item	Art.-No.	Content per can	Max. foam yield (free foaming)	Colour	Sales unit
		[ml]	[l]		
PU 500 B2 (DE)	050426	500	30	beige	12
PU 500 B3 (EN/FR/AR)	058500	500	28	beige	12
PU 750 B2 (DE)	053080	750	45	beige	12
PU 750 B3 (EN/FR/AR)	050427	750	41	beige	12
PU 750 B2 (EN, FR, AR)	534466	750	45	beige	12
PU 1/500 B3 HandHeld (EN/FR)	098010	500	28	beige	12
PU 1/750 B3 HandHeld (EN/FR)	098011	750	41	beige	12

The high-quality 2-component rapid foam with high yield for secure fixing with pull activation



Foaming door frames



Foaming below bath tubs

BUILDING MATERIALS

Bonds to all standard building materials such as:

- Concrete
- Anodised layer
- Gypsum plasterboard
- Wood
- Sand-lime brick
- Plastics (not on PE, PP, Teflon, silicone)
- Masonry
- Metals with priming coat
- Plaster

CERTIFICATES

- General test certificate from building authorities P-NDS04-666

ADVANTAGES

- The humidity-independent system guarantees a controlled foaming, thus ensuring a safe and fast curing without repressing.
- The pull mechanism allows for a simple, safe activation of the components.
- The used solid valve prevents adhesion when being stored horizontally and premature gas loss.
- The extremely uniform and fine-pore foam structure provides high strength values and offers a maximum of functionality.
- The high foam yield allows for the setting of up to 3 door frames. Thus the foam is particularly economical.
- The high resistance to rotting and ageing ensures consistent quality and guarantees a long-lasting fixing.

APPLICATIONS

- Installation of door frames (install expanders)
- Filling and insulating of cavities in walls and ceilings
- Foaming in windows, bath tubs and showers
- Fixing insulating elements, wooden cladding, sheet metal panels, control boxes

FUNCTIONING

- 2-component PU foam
- Building material class B2
- Foam yield of extruded foam 13 l
- Processing temperature +15 °C to +25 °C
- Non-tacky after approx. 6 minutes
- Can be cut after approx. 10 minutes
- Cures after approx. 30 minutes
- Temperature resistant from -40 °C to +90 °C
- Fresh foam stains can be removed immediately with fischer PU cleaner.

TECHNICAL DATA

Item	Art.-No.	Content per can	Max. foam yield (free foaming)	Colour	Sales unit
		[ml]	[l]		[pcs]
2K PU 400 (DE)	053081	400	13	light blue	12

PUP K2



PUP M3



PUP M4 BLACK



ADVANTAGES

- The light construction facilitates use on construction sites and allows for fatigue-free work.
- The impact-requiring control prevents the unintentional unscrewing of the regulating screw, and is therefore particularly user-friendly.
- The gun adapter is suitable for all standard systems and enables universal application.
- Opened cans can remain screwed onto the gun during interruptions of work without curing.

ADVANTAGES

- The PUP M3 meets the tough requirements of a construction site and thus offers a long lifespan.
- The ergonomic handle allows for an ideal position of centre of gravity, and therefore precise handling.
- The infinitely variable control of the foam expulsion allows for a controlled filling and insulating, and enables application-orientated work.
- Opened cans can remain screwed onto the gun during interruptions of work without curing.

ADVANTAGES

- The complete PTFE coating reduces cleaning to a minimum.
- Non-return ball and basket are coated with PTFE. This prevents bonding and guarantees a long-lasting function.
- The perfect combination of the ergonomically shaped handle and trigger makes handling particularly user-friendly.
- The tubes included with the 19 cm long, tapered pistol pipe mean that it can be individually lengthened for use in the narrowest joints, thus offering a high degree of flexibility.

TECHNICAL DATA

Item	Art.-No.	Sales unit [pcs]
PUP K2	062400	1
PUP M3	033208	1
PUP M4 BLACK	513429	1

PU-cleaner



ADVANTAGES

- The active components ensure a high cleaning effect, making the cleaner ideal for the safe removal of fresh PU foam.
- The gun adapter is suitable for all standard systems and enables universal application.
- The separate spray head allows for the cleaning of external surfaces, making the product extremely versatile.
- The highly active cleaner can etch sensitive surfaces (paint, dye, textiles, plastics). Thus you should always conduct preliminary tests.

TECHNICAL DATA

Item	Art.-No.	Contents [ml]	Sales unit [pcs]
PUR 150 (DE)	053083	150	12
PUR 500 (DE/EN)	053085	500	12

The high-quality premium sanitary silicone



Joints in sanitary areas



Sealings in the kitchen

BUILDING MATERIALS

- Chrome
- Stainless steel
- Anodised layer
- Enamel, Tiles
- Glass, glazed surfaces
- Wood (with primer)
- H-PVC
- Ceramics
- Polyester
- Sanitary acrylic

CERTIFICATES

- EN 1565 1 - Part 1: F EXT-INT-CC
- EN 1565 1 - Part 3: S (class XS1)

ADVANTAGES

- The high-quality formulation allows for easy application and smoothing, and ensures efficient work.
- The outstanding movement capacity means that DSSA is ideal for high-stress expansion joints. This guarantees long-lasting jointing.
- The very good hold on smooth surfaces prevents damp from forming in the substrate and guarantees reliable functioning.
- The high wear resistance gives the surface a high level of protection when cleaning. Together with the fungicidal properties, an ideal jointing can be achieved that will last over the long term.

APPLICATIONS

- Corner, movement and connection joints in sanitary areas (sinks, showers, bath tubs, expansion joints between tiles etc.)
- Connection joints in the kitchen
- Window and glass sealings
- Seal welds for display cabinets and glass blocks
- Small-scale adhesions (e.g. window bars)

FUNCTIONING

- Chemical base: 1-component silicone acetate
- Permanently elastic
- With fungicide
- Skin formation time: approx. 6 minutes
- Processing temperature: +5 °C to +35 °C
- Temperature resistance: -50 °C to +200 °C
- Good chemical resistance
- Very good resistance to weather, ageing and UV
- Compatible with paint
- Not paintable
- Free of MDI and solvents
- Selection table for substrates - refer to page 534

TECHNICAL DATA

Item	Art.-No.	Colour	Contents [ml]	Sales unit [pcs]
DSSA TP (DE/EN)	053100	transparent	310	12
DSSA W (DE/EN)	053101	white	310	12
DSSA GR (DE/EN)	053102	grey	310	12
DSSA BG (DE/EN)	053103	bahama beige	310	12
DSSA DG (DE/EN)	053105	dark grey	310	12
DSSA SW (DE/EN)	053120	black	310	12
DSSA SG (DE/EN)	058530	silver grey	310	12
DSSA FUG (DE/EN)	512208	joint grey	310	12
DSSA SAG (DE/EN)	512209	sanitary grey	310	12
DSSA MA (DE/EN)	512210	manhattan	310	12
DSSA AN (DE/EN)	512211	anthracite	310	12

The standard sanitary silicone



Joints in sanitary areas



Wash basins

BUILDING MATERIALS

- Stainless steel
- Anodised layer
- Epoxy
- Tiles
- Glazed surfaces
- Glass
- H-PVC
- Ceramics
- Painted wood
- Polyester

CERTIFICATES

- EN 15651 - Part 1: F EXT-INT-CC
- EN 15651 - Part 2: G-CC
- EN 15651 - Part 3: S (class S1)

ADVANTAGES

- The 20% elasticity means that DSSI is ideal for expansion and connection joints. This guarantees long-lasting jointing.
- The very good hold on smooth surfaces, e.g. tiles, prevents damp forming in the substrate and guarantees reliable functioning.
- The fungicidal properties ensure a clean look over the long term.

APPLICATIONS

- Joints in sinks and toilets
- Expansion joints between floor and wall tiles
- Joints around enamel and plastic showers and bath tubs
- Connection joints between timber and tiles
- Connection joints in the kitchen
- Seal welds for display cabinets and glass blocks
- Glazing wood and aluminium windows

FUNCTIONING

- Chemical base: 1-component silicone acetate
- Permanently elastic
- With fungicide
- Skin formation time: approx. 25 minutes
- Processing temperature: +5 °C to +40 °C
- Temperature resistance: -40 °C to +100 °C
- Shore-A hardness 18
- Permitted overall deformation: 20% (ISO 11600)
- Good chemical resistance
- Very good resistance to weather, ageing and UV
- Not paintable
- Selection table for substrates - refer to page 534

TECHNICAL DATA

Item	Art.-No.	Colour	Contents [ml]	Sales unit [pcs]
DSSI TP (EN/FR/AR)	058515	transparent	280	18
DSSI W (EN/FR/AR)	058516	white	280	18

The silicone sealant with an acetate base for internal and external applications



Joints in sanitary areas



Sealings in the kitchen

BUILDING MATERIALS

- Stainless steel
- Anodised layer
- Epoxy
- Tiles
- Glazed surfaces
- Glass
- H-PVC
- Ceramics
- Painted wood
- Polyester

CERTIFICATES

- EN 1565 1 - Part 1: F EXT-INT-CC
- EN 1565 1 - Part 2: G-CC
- EN 1565 1 - Part 3: S

ADVANTAGES

- Thanks to the practical elasticity of 20%, DMS is ideally suited to connection joints with expansion. This guarantees long-lasting jointing.
- The fungicidal properties ensure a clean look over the long term.
- The very good hold on smooth surfaces prevents damp from forming in the substrate and guarantees reliable functioning.
- The good resistance to UV, weathering and ageing means that DMS can be used both indoors and outdoors, and offers a high level of security over the long term.

APPLICATIONS

- Bathrooms, showers and toilets
- Connection joints to sinks
- Expansion joints between tiles
- Connection joints in the kitchen
- Joints between timber and tiles
- Seal welds for display cabinets and glass blocks

FUNCTIONING

- Chemical base: 1-component silicone acetate
- Permanently elastic
- With fungicide
- Skin formation time: approx. 25 minutes
- Processing temperature: +5 °C to +40 °C
- Temperature resistance: -40 °C to +100 °C
- Shore-A Härte 18
- Permitted overall deformation: 20% (ISO 11600)
- Very good resistance to weather, ageing and UV
- Not paintable
- Selection table for substrates - refer to page 534

TECHNICAL DATA

Item	Art.-No.	Colour	Contents [ml]	Sales unit [pcs]
DMS TP (EN/FR/AR)	040385	transparent	280	18
DMS W (EN/FR/AR)	040386	white	280	18
DMS GR (EN/FR/AR)	040389	grey	280	18
DMS SW (EN/FR/AR)	504413	black	280	18

The silicone sealant for high temperature requirements



Sealing fireplaces



Sealing cookers

BUILDING MATERIALS

- Aluminium (with primer)
- Chrome
- Stainless steel
- Anodised layer
- Enamel
- Tiles
- Glass
- Glazed surfaces
- Ceramics
- Not for corrosive adhesive surfaces such as non ferrous heavy metal, sheet zinc etc.

ADVANTAGES

- The high temperature resistance of up to +300°C means that DHS can be used for joints with increased thermal load.
- Meanwhile, the high resistance to chemicals also allows for use in areas subjected to chemical loads, thus offering a high level of application safety.
- The very good adhesion to smooth surfaces allows for the components to be completely sealed. This allows for reliable functioning.
- DHS is easy to apply and smooth out. This allows for efficient work, and helps to guarantee a simple and time-saving application.

APPLICATIONS

- Sealing of joints around cookers, ovens and fireplaces
- Sealing of joints around boilers and industrial furnaces
- Sealing of joints around pipes and channels subjected to high temperatures
- Sealing of ventilation grilles
- Sealing of air conditioning units

FUNCTIONING

- Chemical base: 1-component silicone acetate
- Permanently elastic
- Skin formation time: approx. 5 - 6 minutes
- Processing temperature: +5 °C to +40 °C
- Temperature resistance: -60 °C to +280 °C (short term to +300 °C)
- Shore-A hardness 40
- Very good resistance to chemicals
- Very good resistance to weather, ageing and UV
- Not paintable
- Free of MDI and solvents
- Selection table for substrates - refer to page 534

TECHNICAL DATA

Item	Art.-No.	Colour	Contents [ml]	Sales unit [pcs]
DHS RB (DE/EN)	053125	reddish brown	310	12

The low-odour premium construction silicone with high adhesive spectrum

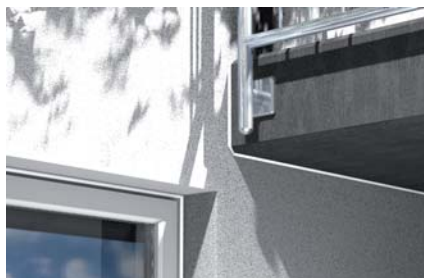

External connection joints

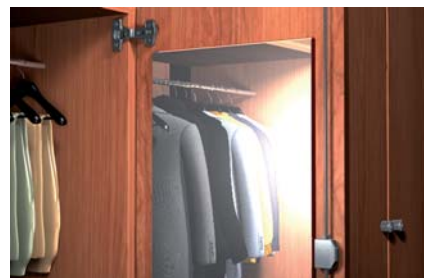

Fixing mirrors

BUILDING MATERIALS

- Concrete
- Chrome
- Stainless steel
- Anodised layer
- Enamel, Tiles, Ceramics
- Glass, glazed surfaces
- Wood (with primer)
- H-PVC
- Copper, brass
- Masonry
- PMMA, PC, Polyester
- Steel
- Zinc

CERTIFICATES

- EN 1565 1 - Part 1: F-EXT-INT-CC (class 25LM)
- EN 1565 1 - Part 2: G-CC (class 25LM)
- EN 1565 1 - Part 3: S (class XS1)

ADVANTAGES

- The high-quality, neutral silicone sealant with a very low volume shrinkage is suitable for demanding applications in construction and the industrial sector, and guarantees a high degree of functional safety.
- DBSA is low-odour and is therefore ideal for use in confined spaces.
- The silicone is easy to apply and smooth out, thus allowing for efficient work and a simple and time-saving jointing.
- The high wear resistance gives the surface a high level of protection when cleaning and thus ensures a perfect look over a long period.

APPLICATIONS

- Connection and expansion joints in the construction industry (e.g. windows, doors, façades, light domes)
- Window glazing
- Movement and connection joints in kitchens, sanitary areas and installations
- Fixing mirrors (transparent version)
- Sealing machines, containers and building apparatus

FUNCTIONING

- Chemical base: 1-component silicone neutral alkoxy
- Fulfils DIN EN ISO 11600 F+G 25
- Permanently elastic
- Low-odour
- With fungicide
- Skin formation time: approx. 12 min
- Processing temperature: +5 °C to +40 °C
- Temperature resistance: -40 °C to +120 °C
- Shore-A hardness 24
- Permitted overall deformation: 25%
- Non-corrosive
- Very good resistance to weather, ageing and UV
- Compatible with paint
- Not paintable
- Resistant to wear and streak-free
- Selection table for substrates - refer to page 534

TECHNICAL DATA

Item	Art.-No.	Colour	Contents [ml]	Sales unit [pcs]
DBSA TP (DE/EN)	053090	transparent	310	12
DBSA W (DE/EN)	053091	white	310	12
DBSA GR (DE/EN)	053092	concrete grey	310	12
DBSA BR (DE/EN)	053093	brown	310	12
DBSA SW (DE/EN)	053094	black	310	12
DBSA BG (DE/EN)	053095	beige	310	12
DBSA SLG (DE/EN)	512213	slate grey	310	12
DBSA ANG (DE/EN)	540084	anthracite	310	12

The versatile construction silicone

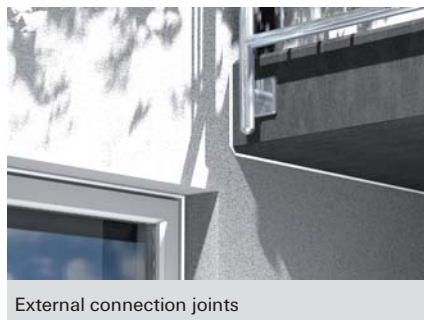

External connection joints



Joints between buildings

BUILDING MATERIALS

- Concrete
- Chrome
- Stainless steel
- Anodised layer
- Enamel
- Epoxy
- Tiles
- Glass, glazed surfaces
- Wood (with primer)
- H-PVC
- Ceramics
- Copper
- Masonry
- Brass
- Polyester
- Steel
- Zinc

CERTIFICATES

- EN 15651 - Part 1: F-EXT-INT
- EN 15651 - Part 2: G
- EN 15651 - Part 3: S

ADVANTAGES

- The neutral silicone sealant is suitable for various applications in construction and the industrial sector, and thus offers a high level of flexibility.
- The high movement capacity means that DBSI is ideal for expansion joints. This guarantees long-lasting jointing.
- DBSI is non-corrosive and is therefore well suited to copper and zinc-plated surfaces. Thus it can be used without problems in the metal processing industry.

APPLICATIONS

- Connection and expansion joints in the construction industry (e.g. windows, doors, façades, light domes)
- Connection joints on windows and doors
- Sealing façades, curtain walling panels and metal structures
- Movement and connection joints in kitchens, sanitary areas and installations

FUNCTIONING

- Chemical base: 1-component silicone neutral oxime
- Permanently elastic
- With fungicide
- Skin formation time: approx. 5 minutes
- Processing temperature: +5 °C to +30 °C
- Temperature resistance: -40 °C to +120 °C
- Shore-A hardness 24
- Non-corrosive
- Very good resistance to weather, ageing and UV
- Compatible with paint
- Not paintable
- Selection table for substrates - refer to page 534

TECHNICAL DATA

Item	Art.-No.	Colour	Contents [ml]	Sales unit [pcs]
DBSI W (DE/EN)	094416	white	310	12
DBSI TP (DE/EN)	094417	transparent	310	12

The discolouration-free silicone sealant for marble and natural stone



Joints on natural stone panels

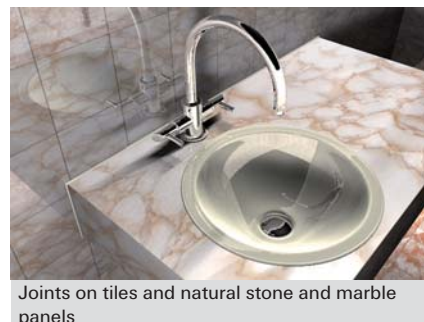

Joints on tiles and natural stone and marble panels

BUILDING MATERIALS

- Marble
- Natural stone (e.g. granite, porphyry, quartzite, sandstone)

Also suitable for:

- Concrete
- Stainless steel
- Anodised layer
- Tiles, Ceramics
- Glass
- Wood (with primer)
- H-PVC
- Copper
- Masonry
- PMMA, PC
- Sanitary acrylic
- Steel
- Zinc

CERTIFICATES

- EN 15651 - Part 1: F-EXT-INT-CC (class 25LM)
- EN 15651 - Part 2: G-CC (class 25LM)
- EN 15651 - Part 3: S

ADVANTAGES

- The specially adapted formulation prevents edge soiling and gives a lasting clean look, particularly for natural stone and marble.
- DNS is easy to use and smooth, thus allowing for efficient work. This guarantees a fast and simple jointing.
- The neutral interlacing silicone with an alkoxy base is low-odour and is therefore ideal for use in confined spaces.

APPLICATIONS

- Sealing and jointing marble and natural stone for internal and external use
- Joints in sanitary areas
- Joints in façade construction
- Corner joints in floors and walls
- Movement-compensating adhesion of natural stone onto metal structures (e.g. stair treads)

FUNCTIONING

- Chemical base: 1-component silicone neutral alkoxy
- Permanently elastic
- Low-odour
- With fungicide
- Skin formation time approx. 15 minutes
- Processing temperature: +5 °C to +40 °C
- Temperature resistance: -40 °C to +120 °C
- Shore-A hardness 21
- Non-corrosive
- Good chemical resistance
- Very good resistance to weather, ageing and UV
- Compatible with paint
- Not paintable
- Selection table for substrates - refer to page 534

TECHNICAL DATA

Item	Art.-No.	Colour	Contents [ml]	Sales unit [pcs]
DNS TP (DE/EN)	053121	transparent	310	12

The hardly flammable silicone sealant



Joints on fire protection doors



Sealings in public buildings

BUILDING MATERIALS

- Concrete
- Chrome
- Stainless steel
- Anodised layer
- Enamel
- Tiles
- Glass, glazed surfaces
- Ceramics
- Copper, brass
- Masonry
- Polyester
- Steel
- Zinc

CERTIFICATES

- EN 15651 - Part 1: F-EXT-INT-CC (class 25LM)
- EN 15651 - Part 2: G-CC (class 25LM)

ADVANTAGES

- The good fire-inhibiting properties provide maximum safety for the sealing of solid, mineral or metal building materials.
- Non-corrosive, thus can be used on aluminium, copper and zinc-plated surfaces. This guarantees problem-free use within the metal processing industry.
- Due to the audited, high 25% elasticity, DFS is particularly suitable for joints subjected to high stress. This guarantees a permanent seal.

APPLICATIONS

- Sealing connection and expansion joints that are required to have a fire-resistant effect against the spreading of fire, water, smoke and poisonous fumes
- Sealing components that have increased requirements concerning their properties in the case of fire

FUNCTIONING

- Chemical base: 1-component silicone neutral
- Hardly flammable material (building material class DIN 4102-B1) in line with DIN 4102-1
- Permanently elastic
- Shore-A hardness 20
- Skin formation time: approx. 10 minutes
- Processing temperature: +5 °C to +40 °C
- 100% modulus 0,40 N/mm²
- Temperature resistance: -40 °C to +120 °C
- Non-corrosive
- Very good resistance to weather, ageing and UV
- Compatible with paint
- Not paintable
- Selection table for substrates - refer to page 534

TECHNICAL DATA

Item	Art.-No.	Colour	Contents [ml]	Sales unit [pcs]
DFS GR (DE/EN)	053131	grey	310	12

The universal hybrid-sealant-adhesive for indoor and outdoor use



Bonding and sealing of attachments



Sealing ventilation ducts

BUILDING MATERIALS

- Aluminium
- Concrete
- Chrome
- Stainless steel
- Anodised layer
- Tiles
- Glass, glazed surfaces
- H-PVC
- Ceramics
- Copper, brass
- Masonry
- PMMA, PC
- Polyester
- Steel
- Zinc

CERTIFICATES

- LEED® IEQ-credits 4.1 (Indoor Environmental Quality) adhesives and sealants
- **Coloured version:**
- EN 15651 part 1: F-EXT-INT-CC (Class 25 HM)
- EN 15651 - Part 3: S (XS3)
- EN 15651 - Part 4: PW-EXT-INT-CC (Class 25 HM)
- Suitable for use in room ventilation systems according to VDI 6022 (Ass. Of Germ. Engineers), sheet 1 tested according to DIN EN ISO 846
- Declaration of no objection - tested for use in food-related area (ISEGA)
- GEV-EMICODE EC1 PLUS - very low emission
- M1 emission classification for building materials

ADVANTAGES

- Due to the high 25% flexibility, DKM is particularly suitable for joints subjected to high stress. This guarantees a permanent seal.
- The high initial adhesion from up to 75 kg/m² (50 kg/m² crystal clear) makes it possible to attach lots of components without the need for additional fixing, and thus reduces the amount of time required.
- The mould inhibiting quality guarantees the tested antibacterial inertness over a long period.
- DKM is low-odour and is therefore ideal for the use in confined spaces.

APPLICATIONS

- Attachment of strips, panels, cladding and insulation materials to wall
- Connection and expansion joints in the building industry according to EN 15651-1 (20 HM) as well as for general joint sealing
- In building work, and joint and seam sealing in climate and ventilation technology (HVAC systems according to DIN EN ISO 846)
- Sealing and attaching metal constructions, sheet reinforcements on chimneys and windowsills, eaves flashing attachment on flat roofs and skylights
- Colored version suitable for mirror bonding

FUNCTIONING

- Chemical base: 1K Hybrid
- Approved acc. to DIN EN ISO 846 (coloured version)
- Permanently elastic
- Low-odour
- Mould inhibiting quality
- Skin formation time: approx. 10 minutes
- Processing temperature: +5 °C to +40 °C
- Temperature resistance: -40 °C to +90 °C
- Total authorised deformation: 25 %
- Non-corrosive
- Bonds on a moist base material
- Very good resistance to weather, ageing and UV (coloured version)
- Compatible with paint and paintable
- Free of silicone, MDI and solvents
- Selection table for substrates - refer to page 534

TECHNICAL DATA

Item	Art.-No.	Colour	Contents [ml]	Sales unit [pcs]
DKM-290ML	517598	white	290	12
DKM-290 ML grey (DE/EN)	517599	grey	290	12
DKM-290 ML black (DE/EN)	517600	black	290	12
DKM-290 ML beige (DE/EN)	533831	beige	290	12
DKM-290 ML transparent (DE/EN)	533830	crystal clear	290	12

The elastic acrylic sealant for internal and external applications with immediate rain resistance



External connection joints



Connection joints in the outdoor area

BUILDING MATERIALS

- Concrete
- Anodised layer
- Fibre cement
- Gypsum
- Gypsum plasterboard
- Wood
- H-PVC
- Sand-lime brick
- Clinker brick
- Masonry
- Metal
- Aerated concrete
- Plaster
- Brick
- Zinc

TEST CERTIFICATE

- EN 15651-1: F-EXT-INT (class 12.5P)
- GEV-EMICODE EC1 PLUS - very low emission
- French VOC-emission class A+

ADVANTAGES

- The immediate rain resistance allows for external application in all weather conditions, thus avoiding interruption of work.
- The high movement capacity means that DFA is ideal for expansion joints. This guarantees long-lasting jointing.
- The optimised formulation ensures that strongly absorbent substrates do not cause splitting in the joints. This increases functional safety.
- The water-based acrylate sealant has a neutral odour and is therefore ideal for use in confined spaces.

APPLICATIONS

- For internal and external application
- Internal connection joints between wood, plastic and metal windows and walls
- Joints in dry and internal construction
- Joints between stairs and walls, ceilings and walls
- Connection joints for shutter boxes and window sills
- Renovation work (split jointing)

FUNCTIONING

- Chemical base: 1-component dispersion acrylic
- Elasto-plastic
- Low-odour
- Skin formation time: approx. 5 minutes
- Processing temperature: +5 °C to +40 °C
- Permissible total deformation 20 % (according to ISO 7389)
- Temperature resistance: -20 °C to +75 °C
- Non-corrosive
- Very good resistance to weather, ageing and UV
- Compatible with paint
- Can be painted and plastered
- Frost-protected in the cartridge
- Free of silicone, MDI and solvents

TECHNICAL DATA

Item	Art.-No.	Colour	Contents [ml]	Sales unit [pcs]
DFA WH 310 (DE/EN)	541709	white	310	12

Quick paintable sealant with maximum security against cracks and discolourations



Wall connection joints

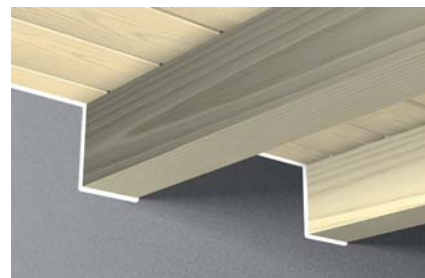

Internal expansion joints

BUILDING MATERIALS

- Concrete
- Anodised layer
- Gypsum
- Gypsum plasterboard
- Wood
- H-PVC
- Sand-lime brick
- Clinker brick
- Masonry
- Polystyrene
- Aerated concrete
- Plaster
- Brick

PRÜFZEUGNIS

- EN 1565 1-1:2012: Type F -EXT-INT (class 7,5P)
- GEV-EMICODE EC1 PLUS - very low emission
- French VOC-emission class A+

ADVANTAGES

- The sealant can be painted after already one hour, allowing subsequent painting work to start more quickly.
- The further-developed DMA formulation suppresses paint cracking, thus eliminating the need for time-consuming rework.
- The really good paint compatibility ensures the great adhesion of commercially available paints to the sealant and prevents the discolouration of the paint layer. This guarantees a good, even appearance.
- The water-based acrylate sealant has a neutral odour and is free from phthalate plasticisers, making it ideal for use in confined spaces.

APPLICATIONS

- For internal and external application
- For sealing joints between wooden and metal window frames and concrete/masonry
- Joints between walls and ceilings, steps and walls, concrete and ceiling elements and skirting
- Connection joints for shutter boxes and window sills
- Joints in dry and internal construction
- Renovation work (split jointing)

FUNCTIONING

- Chemical base: 1-component dispersion acrylic
- Elasto-plastic
- Low-odour
- Skin formation time: approx. 10 minutes
- Processing temperature: +5 °C to +40 °C
- Adheres on moist substrates
- Practically no shrinkage
- Temperature resistance: -20 °C to +75 °C
- Non-corrosive
- Very good resistance to weather, ageing and UV
- Compatible with paint
- Can be painted and plastered
- Free of silicone, MDI and solvents
- Selection table for substrates - refer to page 534

TECHNICAL DATA

Item	Art.-No.	Colour	Contents [ml]	Sales unit [pcs]
DMA W (DE/EN)	512186	pure white	310	12

The structured acrylic sealant for plastered walls



Joints in the roof area



Closing external masonry cracks

BUILDING MATERIALS

- Concrete
- Anodised layer
- Gypsum
- Gypsum plasterboard
- Wood
- H-PVC
- Sand-lime brick
- Clinker brick
- Masonry
- Polystyrene
- Aerated concrete
- Plaster
- Brick

CERTIFICATES

- EN 15651 - Part 1: F-EXT-INT

ADVANTAGES

- The pitted structure is ideal for coarse surfaces, and ensures a perfect appearance, e.g. on rough plaster.
- The sealant can be painted and plastered and allows for an outstanding hold of standard paints/plasters on the sealant, thus guaranteeing a non-critical post-treatment.
- The good resistance to UV, weather and ageing allows for use both indoors and outdoors. This guarantees versatile and long-lasting jointing.

APPLICATIONS

- Filler paste to repair coarse surfaces on internal and external walls
- Connection joints with low movement
- Joints in dry and internal construction
- Joints between walls and ceilings
- Joints on window and shutter connections

FUNCTIONING

- Chemical base: 1-component dispersion acrylic
- Elasto-plastic
- Low-odour
- Skin formation time: approx. 5 minutes
- Processing temperature: +5 °C to +40 °C
- Temperature resistance: -20 °C to +75 °C (rain-resistant once cured)
- Non-corrosive
- Very good resistance to weather, ageing and UV
- Compatible with paint
- Paintable
- Frost-protected in the cartridge
- Free of silicone, MDI and solvents
- Selection table for substrates - refer to page 534

TECHNICAL DATA

Item	Art.-No.	Colour	Contents [ml]	Sales unit [pcs]
DSA W (DE/EN)	512185	white	310	12

The acrylic sealant for internal joints



Sealing door frames



Closing internal masonry cracks

BUILDING MATERIALS

- Concrete
- Anodised layer
- Gypsum
- Gypsum plasterboard
- Wood
- H-PVC
- Sand-lime brick
- Clinker brick
- Masonry
- Aerated concrete
- Plaster
- Brick

CERTIFICATES

- EN 15651 - Part 1: F-EXT-INT

ADVANTAGES

- The good hold on absorbent substrates guarantees a secure sealing and thus allows for a reliable and economic application.
- The sealant can be painted and plastered and allows for a good hold of standard paints/plasters on the sealant, thus guaranteeing a non-critical post-treatment.
- The water-based acrylate sealant has a neutral odour and is therefore ideal for use in confined spaces.

APPLICATIONS

- Fractures in masonry and other solid building materials in internal areas
- Connection joints with low movement
- Joints in window sill connections
- Connection joints inside buildings between windows, doors, stairs, ceilings and walls

FUNCTIONING

- Chemical base: 1-component dispersion acrylic
- Elasto-plastic
- Low-odour
- Skin formation time: approx. 20 minutes
- Processing temperature: +5 °C to +40 °C
- Temperature resistance: -20 °C to +75 °C
- Non-corrosive
- Compatible with paint
- Can be painted and plastered
- Frost-protected in the cartridge
- Free of silicone, MDI and solvents
- Selection table for substrates - refer to page 534

TECHNICAL DATA

Item	Art.-No.	Colour	Contents [ml]	Sales unit [pcs]
DA W (DE/EN)	053110	white	310	12
DA GR (DE/EN)	053111	grey	310	12
DA BR (DE/EN)	053112	brown	310	12
DA W (EN/FR/AR)	058512	white	280	24

The ready-to-use, extrudable joint mortar for the long-lasting closing of masonry joints



Masonry joints



Wall breakthrough

BUILDING MATERIALS

- Concrete
- Pumice
- Fibre cement
- Gypsum
- Wooden materials
- Sand-lime brick
- Ceramics
- Clinker brick
- Masonry
- Aerated concrete
- Plaster
- Cement
- Brick

ADVANTAGES

- The ready-to-use, sprayable joint mortar means that there is no need to add water or carry out time-consuming pre-mixing work. It enables clean, purposeful work. This means that you avoid dirtying surrounding areas and wasting material.
- Good adhesion even on slightly damp substrates practically allows for all-weather work and prevents forced interruptions.
- The structure of the high-quality water-based polymer has been perfectly designed with the visual appearance of the mortar in mind. This ensures a discreet joint and perfect appearance.

APPLICATIONS

- Repairing masonry joints
- Closing masonry cracks
- Fixing roof tiles
- Bonding tiling and bricks
- Repairing chipped edges
- Closing drill holes in facing masonry during repair work
- General repair work (e.g. drill holes with cracked edges)
- For a better reusability, to close opened cartridges with adhesive tape

FUNCTIONING

- Chemical base: 1C polymer dispersion
- Plastic
- Consistency: Firm
- Practically odour-free
- Skin formation time: Approx. 10 minutes.
- Processing temperature: +5 °C to +40 °C (not below +5 °C)
- Temperature resistance up to -30 °C (fully cured)
- Weather-proof after approx. 24 hours.
- Very good resistance to UV, weather and ageing
- Paintable
- Frost-protected in the cartridge
- Free of silicone, MDI and solvents- Selection table for substrates - refer to page 534

TECHNICAL DATA

Item	Art.-No.	Colour	Contents	Contents per plastic bag	Sales unit
			[ml]	[pcs]	[pcs]
DEC CG (DE/EN)	534474	cement grey	310	–	12
V-Nozzle Express Cement	524315	–	–	5	1

The permanently elastic joint sealant with a strong hold on all substrates



Chimney flashings



Sealing gutters

BUILDING MATERIALS

- Concrete
- Bitumen sheeting
- Roofing felt
- Stainless steel
- Wood
- Clinker brick
- Copper
- Masonry
- Metal
- Brick
- Zinc

12

Foams, sealants

ADVANTAGES

- Thanks to the high elasticity of 25%, DDK is ideally suited to high-stress joints. This guarantees long-lasting jointing.
- DDK holds without a base coat, including on moist and bituminous substrates, and is therefore suitable for all applications in the roofing area. For a high degree of economy.
- The immediate rain resistance allows for external application in all weather conditions, thus avoiding interruption of work.
- DDK is non-corrosive, and thus can be used on aluminium, copper and zinc-plated surfaces. This offers maximum flexibility.

APPLICATIONS

- Sealing of roofing membranes
- Grouting roof penetrations such as chimneys or light domes, as well as edge connections
- Sealing of metal and plastic gutters
- Sealings around antennas and ventilation ducts
- Sealing of chimney flashings
- Sealant for metal structures

FUNCTIONING

- Chemical base: 1-component synthetic rubber
- Permanently elastic
- Highly transparent formulation
- Skin formation time: 15 - 20 minutes
- Processing temperature: +5 °C to +40 °C
- Temperature resistance: -25 °C to +100 °C
- Permitted overall deformation: 25%
- Allows for emergency roof repairs
- Non-corrosive
- Very good resistance to weather, ageing and UV
- Compatible with paint
- Paintable
- Frost-protected in the cartridge
- Selection table for substrates - refer to page 534

TECHNICAL DATA

Item	Art.-No.	Colour	Contents [ml]	Sales unit [pcs]
DDK TR (DE/EN)	049103	transparent	310	12

The special sealant to fill joints between bitumen sheeting



Sealings around skylights



Sealings around roofs with bitumen sheeting

BUILDING MATERIALS

- Concrete
- Bitumen sheeting
- Roofing felt
- Stainless steel
- Wood
- Clinker brick
- Copper
- Plastics
- Masonry
- Metal
- Brick
- Zinc
- Polystyrene

ADVANTAGES

- The special bitumen-based formulation seals roofing membranes and roofing felt securely. This guarantees long-lasting functionality.
- DD also holds to moist substrates without a base layer. This makes application largely independent of the weather and thus helps to avoid interruption of work.
- DD is non-corrosive, and thus can be used on aluminium, copper, zinc-plated surfaces and polystyrene. This offers maximum flexibility.

APPLICATIONS

- Sealing roofing membranes and roofing felt
- Bonding bitumen shingle
- Grouting roof penetrations such as chimneys or light domes, as well as edge connections
- Sealing of metal and plastic gutters
- Sealings around antennas and ventilation ducts

FUNCTIONING

- Chemical base: 1-component bitumen
- Odorless, because it is solvent-free
- Plastic
- Skin formation time > 15 hours
- Processing temperature: +5 °C to +40 °C
- Temperature resistance: -20 °C to +80 °C
- Max. movement absorption 10%
- Non-corrosive
- Selection table for substrates - refer to page 534

TECHNICAL DATA

Item	Art.-No.	Colour	Contents [ml]	Sales unit [pcs]
DD SW (DE/EN)	053127	black	300	12

KP M1



ADVANTAGES

- The handy, robust solid metal construction for standard cartridges up to 310 ml bears up against requirements on the construction site and, as such, is also suitable for professional use.
- The continuous in-feed allows for a precise dosage, making it easy to use.
- The slim shape of the device allows for an exact application, even in difficult to reach spots, thus offering a high level of flexibility

KP M2



ADVANTAGES

- The 18:1 transmission ratio makes extrusion rapid and energy-efficient even in the case of highly viscous materials, thus guaranteeing stress-free work.
- The robust design with the special, hardened drive block meets the tough requirements of a construction site and thus offers a long lifespan.
- Due to the accessible cartridge, it is possible to align the extrusion nozzle perfectly in place and guarantee application-orientated work.

KP M3



ADVANTAGES

- The 18:1 transmission ratio makes extrusion rapid and energy-efficient even in the case of highly viscous materials, thus guaranteeing stressfree work.
- The robust design with the hardened twice drive blocks and the hardened push rod meets the tough requirements of a construction site and thus offers a long lifespan.
- The electro-welded cartridge shell is freely rotatable.
- Due to the accessible cartridge, it is possible to align the extrusion nozzle perfectly in place and guarantee application-orientated work.
- The equipment with a ladder hook facilitates the retraction of the push rod and offers a convenient possibility of depositing during work interruptions.

TECHNICAL DATA

Item	Art.-No.	Sales unit [pcs]
KP M1	053115	1
KP M2	053117	1
KP M3	541441	1

KP M600



ADVANTAGES

- The 18:1 transmission ratio makes extrusion rapid and energy-efficient even in the case of highly viscous materials, thus guaranteeing stressfree work.
- The robust design with the hardened push rod with anti-slip effect withstands the tough requirements of a construction site and thus offers a long lifespan.
- The equipment with a ladder hook facilitates the retraction of the push rod and offers a convenient possibility of depositing during work interruptions.
- Automatic tension remove (with on / off function) prevents run after.
- 2 different pusher plates (plastic for tubular bags & metal for cartridges) enable flexible use.

TECHNICAL DATA

Item	Art.-No.	Sales unit [pcs]
KP M600	540941	1

SEALANT SELECTION MATRIX











	Chem. basis	Substrates																								
		ABS / Polystyrene	Acrylic glass (Macrolon, perspex etc.)	Acrylic tubs (sanitary acrylic)	Aluminium	Concrete	Concrete block	Bitumen	Non ferrous heavy metal (copper, brass)	Stainless steel	Sandblasted iron	Enamel	Tiles	Gypsum / gypsum plasterboard	Glass	Hard PVC	Wood	Ceramics	Natural stone / marble	Polyester	Aircrete	Plaster	Resopal	Stoneware	Brick / clinker brick	Zinc / galvanizing
DSSA Premium sanitary silicone	Silicone acetate	+	-	+	+	-	-	-	-	+	-	+	+	-	+	+	+	+	-	+	-	-	+	+	-	-
DSSI Sanitary silicone	Silicone acetate	-	-	+	+	-	-	-	-	+	-	+	+	-	+	+	+	+	-	+	-	-	+	+	-	-
DMS Multi-silicone	Silicone acetate	+	-	T	+	-	-	-	-	+	-	+	+	-	+	-	+	+	-	+	-	-	+	+	-	-
DHS Premium high temperature silicon	Silicone acetate	+	-	-	+	T	-	-	T	+	-	+	+	T	+	-	+	+	-	+	T	T	+	+	T	T
DBSA Premium construction silicone	Silicone alkoxy	+	+	T	+	+	-	-	+	+	+	+	+	+	+	+	+	+	-	+	+	+	+	+	+	+
DBSI Roof and wall silicone	Silicone oxime	+	-	+	+	+	-	-	+	+	+	+	+	+	+	+	+	+	-	+	+	+	+	+	+	+
DNS Premium silicone for natural stone	Silicone oxime	+	-	+	+	+	+	-	+	+	+	+	+	+	+	+	+	+	+	+	+	+	+	+	+	+
DFS Premium B1 silicone	Silicone oxime	+	+	+	+	+	-	-	+	+	+	+	+	+	+	+	+	+	-	+	+	+	+	+	+	+
DKM Construction sealant Premium	Hybride	T	+)1	+	+	+	-	-	+	+	+	+	+	+	+	+	+	+	-	+	+	+	+	+	+	+
DFA Facade acrylic Premium	Dispersion acrylic	-	-	-	+	+	-	-	+	+	-	+	+	-	+	+	+	+	-	+	+	+	+	+	+	+
DMA Premium painting acrylic	Dispersion acrylic	-	-	-	+	+	-	-	+	+	-	+	+	-	+	+	+	+	-	+	+	+	+	+	+	+
DSA Premium structured acrylic	Dispersion acrylic	-	-	-	+	+	-	-	-	+	-	-	+	+	+	-	T	+	T	-	+	+	+	+	+	+
DA Acrylic Sealant	Dispersion acrylic	-	-	-	+	+	-	-	-	+	-	-	+	T	-	-	+	T	-	+	+	+	+	+	+	T
DDK Premium all-weather sealant	Synthetic rubber	+	-	-	+	+	-	+	+	+	-	+	-	-	+	+	+	-	+	+	+	+	+	+	+	+
DD Roof sealing compound	Bitumen	-	-	-	+	+	-	+	+	+	-	+	-	-	-	+	+	-	+	-	T	-	+	+	+	

1) perspex not

Note: Avoid direct contact between the silicone and bituminous or plasticiser materials (e.g. EPDM, butyl, neoprene). The written and spoken information contained in this technical datasheet and our practical support is provided to the best of our knowledge and does not represent binding information or guarantees as described in § 443 of the German Civil Code. We recommend that you test the suitability of our products for the intended application prior to use. Due to the diverse range of applications of the individual product and the unpredictable conditions on site, we also recommend testing the adhesion prior to use.

SEALANT COLOUR BOARD







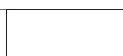
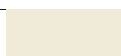

DSSA Premium sanitary silicone

										
Art.-No. 53100	Art.-No. 53101	Art.-No. 53103	Art.-No. 58530	Art.-No. 512208	Art.-No. 53102	Art.-No. 512209	Art.-No. 512210	Art.-No. 53105	Art.-No. 512211	Art.-No. 53120
transparent	white	bahama beige	silver grey	joint grey	grey	sanitary grey	manhattan	dark grey	anthracite	black

DHS Premium high temperature silicone

Art.-No. 53125
reddish brown





DBSA Construction silicone

										
Art.-No. 53090	Art.-No. 53091	Art.-No. 540085	Art.-No. 53095	Art.-No. 540084	Art.-No. 540086	Art.-No. 53092	Art.-No. 540087	Art.-No. 53093	Art.-No. 512213	Art.-No. 53094
transparent	white	cream white RAL 9001	beige	grey	aluminium RAL 9006	concrete grey	aluminium RAL 9007	brown	slate grey	black

DFS Premium B1 silicone

Art.-No. 53131
grey

DA Acrylic sealant

			
Art.-No. 53110	Art.-No. 58512	Art.-No. 53111	Art.-No. 53112
white	white	grey	brown



Example of use for sealants

- | | |
|--|--|
| 01 DSSA Premium sanitary silicone | 06 DMA Premium painting acrylic |
| 02 DHS Premium high temperature silicone | 07 DA Acrylic sealant |
| 03 DBSA Premium construction silicone | 08 DSA Premium structured acrylic |
| 04 DBSI Roof and wall silicone | 09 DFA Premium acrylic sealant facade |
| 04 DNS Premium silicone for natural stone | 10 DDK Premium all-weather sealant |
| 05 DFS Premium B1 silicone | 11 DD Roof sealing compound |

Fast-drying surface and corrosion protection with outstanding long-term effect for metals.



Column bases



Stand mounting

BUILDING MATERIALS

- All iron and steel surfaces
- Blank laminations

12

Foams, sealants

ADVANTAGES

- In the salt spray test in line with DIN 50021, coated metal parts displayed no corrosion, even after 500 hours.
- The high proportion of zinc in the dry film provides secure protection to all metal surfaces that are permanently exposed to the elements.
- Thanks to the adhesive layer of corrosion protection and the fact that it can be painted over, it is also ideal as a high-quality base layer.
- The high resistance to cracking and flaking of a metal base material was confirmed by the mandrel flex test in line with DIN EN ISO 1519 (without damage).

APPLICATIONS

- For all metals that need corrosion protection
- Rust protection base layer for surfaces threatened by water and weather
- For the coating of drilling and cutting points as well as welded joints
- Conductive interlayer for spot welding
- Repairing damaged zinc coatings

FUNCTIONING

- Dark-grey colour (similar to RAL 7042)
- Metal proportion of over 92% in dry film
- Shake can well for approx. 3 minutes
- Apply at a distance of 20–30 cm in a cross coat
- Surface dust-dry after just approx. 8 minutes
- Fully hardened within 24 hours
- Smooth, non-porous film
- Abrasion-resistant
- Excellent corrosion protection with long-term effect
- Heat-resistant up to approx. 500 °C
- Electroconductive and suitable for spot welding
- Ideal processing temperature of 16 °C to 25 °C

TECHNICAL DATA

Item	Art.-No.	Contents [ml]	Sales unit [pcs]
FTC-ZS (EN/FR/ES/PT)	509242	400	12

Bright color as newly galvanised metals in combination with heat-resistant corrosion protection due to flake technology.



Metal stairs



Roof construction: metal structures

BUILDING MATERIALS

- All iron and steel surfaces
- Hot-dip galvanised surfaces following drilling, ironwork or welding
- Non-ferrous heavy metal
- Blank laminations

ADVANTAGES

- In the salt spray test in line with DIN EN ISO 9227, coated metal parts displayed no corrosion, even after 300 hours.
- The innovative metal flakes form a highly resistant protective layer, even against extreme weather influences. This guarantees long-lasting protection.
- The color "bright grade" has been perfectly adapted to that of hot-dip galvanisation. This acts as an optical color compensator.
- Thanks to the excellent holding properties on blank metal, it guarantees a lasting connection to the base material.

APPLICATIONS

- For all metals that need corrosion protection
- For HVAC systems
- For post-galvanising and repairing damaged areas of galvanised parts
- Metal constructions
- Guard rails
- For the coating of drilling and cutting points as well as welded joints
- Conductive interlayer for spot welding

FUNCTIONING

- Zinc coating in fresh hot-dipped coloring with high gloss level (RAL 9006)
- Flaky metal pigments
- Metal content in dry film > 60%
- Shake can well for approx. 2 minutes
- Apply at a distance of 25 - 30 cm in a cross coat
- Surface dust-dry after just approx. 8 minutes
- Surface is dust-dry after approx. 15 minutes and fast to handle after approx. 60 minutes
- Fully hardened within 24 hours
- Long-term heat resistance up to approx. +300 °C
- Ideal processing temperature of +16 °C to +25 °C
- High abrasion resistance

TECHNICAL DATA

Item	Art.-No.	Contents [ml]	Sales unit [pcs]
FTC-ZB (EN/FR/ES/PT)	534786	400	12
FTC-ZB (EN/AR/FR/PT)	537223	400	12

Ideal for repairing damaged zinc coatings using colour-matching corrosion protection.



Ventilation systems



Ladders

BUILDING MATERIALS

- All iron and steel surfaces
- Hot-dip galvanised surfaces following drilling, ironwork or welding
- Non-ferrous heavy metal

ADVANTAGES

- Zinc-alu spray represents a subtle repair to damaged hot-dip galvanised areas thanks to its colour matching with the hot-dip galvanisation.
- Thanks to the excellent holding properties on blank metal, it guarantees a lasting connection to the base material.
- The fast-drying Zinc-alu spray guarantees good, weatherproof corrosion protection and, as such, is suitable for use both indoors and out.

APPLICATIONS

- For post-galvanising and repairing damaged areas of galvanised parts, drilling and cutting points and welded joints
- Repairing damaged zinc coatings
- Climate control and ventilation technology
- Guard rails
- Metal constructions
- Sheet metal coverings

FUNCTIONING

- Silver-grey colour (similar to RAL 9006) with high gloss level
- Shake can well for approx. 2 minutes
- Apply at a distance of 25–30 cm in a cross coat
- Surface dust-dry after just approx. 8 minutes
- Touch-dry after 20–25 minutes
- Fully hardened within 24 hours
- Smooth, non-porous film
- High abrasion resistance
- Long-term heat resistance up to approx. 200 °C (briefly up to 300 °C)
- Ideal processing temperature of 16 °C to 25 °C

TECHNICAL DATA

Item	Art.-No.	Contents [ml]	Sales unit [pcs]
FTC-ZA (EN/FR/ES/PT)	509241	400	12







fischer
KD WEISS/WHITE
Multi Kleb- und Dichtstoff
MS Polymer®
All Round Adhesive Gluing & Sealing
MS Polymer®



fischer KK BEIGE
Kraft-Kleber Express
Polyurethan
Power Adhesive Express
Polyurethane
100% PU
+110°C
-40°C
1,085 kg e 310 ml



13 Adhesives

		Page
Assembly adhesive MK		542
Power adhesive express KK		543
All-round adhesive gluing and sealing KD		544
All-round adhesive gluing and sealing KD transparent		545
Flexible power adhesive premium HTM		546

The building adhesive for interior areas with high initial adhesion



Skirting



Timber constructions

BUILDING MATERIALS

- Concrete
- Pumice
- Fibre cement
- Gypsum
- Gypsum plasterboard
- Wood
- H-PVC
- Sand-lime brick
- Clinker brick
- Masonry
- Metal
- Polystyrene hard foam
- Aerated concrete
- Plaster
- Brick

CERTIFICATES

- Conform to LEED® IEQ-credits 4.1 (Indoor Environmental Quality) adhesives and sealants

ADVANTAGES

- The extremely high initial adhesion of 140 kg/m² makes it possible to attach lots of components without the need for additional fixings, and thus reduces the amount of time required.
- The components can be adjusted for a few minutes after they have been attached. This makes installation easier.
- The acrylate adhesive has a neutral odour and is therefore ideal for use in confined spaces.
- The special recipe makes it compatible with foamed polystyrene, e.g. Styrofoam®. MK is, therefore, suitable for a broad range of applications.

APPLICATIONS

- Skirting
- Timber sub-structures
- Décorative, acoustic and insulation panels
- Cable ducts
- Window sills
- Tiles
- Door signs

FUNCTION / ASSEMBLY

- Chemical base: One-component acrylate dispersion
- Creme white in colour
- Processing temperature +5 °C to +35 °C
- Setting time approx. 15 minutes
- High initial adhesion of 140 kg/m²
- Fully functional after 24 to 48 hours
- High ultimate strength (up to 22 kg/cm² for wood to wood)
- Temperature resistance -20 °C to +70 °C
- Non-drip (suitable for use on ceilings)
- Addresses uneven surfaces
- At least one of the components to be bonded must be absorbent.
- Reclosable nozzle
- Free from solvents, silicone and MDI
- Extrude with silicone application gun

TECHNICAL DATA

Item	Art.-No.	Contents [ml]	Contents [g]	Type of packaging	Colour	Sales unit [pcs]
MK WHITE 310ML (DE/EN)	053128	310	400	Cartridge	white	12

The building adhesive for extremely fast and water-resistant bond with a high final strength



Capstones



Bonding in interior construction

BUILDING MATERIALS

- ABS
- Concrete
- Pumice
- Anodised layer
- Fibre cement
- Gypsum
- Gypsum plasterboard
- Wooden materials
- H-PVC
- Sand-lime brick
- Ceramics
- Clinker brick
- Masonry
- Metal
- Natural stone
- Polystyrene hard foam
- Aerated concrete
- Plaster
- Brick

CERTIFICATES

- According to the requirements of DIN EN 204-D4 to weathering resistant bondings of wood and derived wood products
- According to the requirements of DIN EN 14257 (Watt 91) to temperature-resistant bondings of wood and derived wood products
- Conform to LEED® IEQ-credits 4.1 (Indoor Environmental Quality) adhesives and sealants
- EMICODE® EC 1 Plus - very low emission

ADVANTAGES

- The polyurethane adhesive is resistant to moisture and thus can be used in exterior areas.
- The extremely quick hardening shortens the pressing and joining times. Thus subsequent work can be completed more quickly.
- The optimised recipe achieves a high adhesion, including in the case of high temperatures, for high security.
- The special recipe makes it compatible with foamed polystyrene, e.g. Styro-foam®. Thus, KK is suitable for a broad range of applications.

APPLICATIONS

- Gluing timber sub-structures
- Stair construction and stair renovations
- Laminate cladding
- Skirting boards
- Décorative, acoustic and insulation panels
- Professional modelling
- Door signs
- Cable ducts
- General repair and installation mortar

FUNCTION / ASSEMBLY

- Chemical base: One-component PUR adhesive
- Beige in colour
- Processing temperature 0 °C to +35 °C
- Setting time approx. 3 minutes
- Fully functional after approx. 10 minutes (for invisible joints)
- High final strength of > 10 N/mm² (> 100 kg/cm²)
- Temperature resistance -40 °C to +110 °C
- Non-drip (suitable for use on ceilings)
- Lightly foaming / bridges gaps
- Assembly parts have to be fixed until functional strength has been reached
- Reclosable nozzle
- Free from solvents and silicone
- Extrude with silicone application gun

TECHNICAL DATA

Item	Art.-No.	Contents [ml]	Contents [g]	Type of packaging	Colour	Sales unit [pcs]
KK BEIGE 310ML (DE/EN)	059014	310	460	Cartridge	beige	12

The flexible adhesive and sealant for interior and exterior use with high initial tack even on wet surfaces



Sheet metal coverings



Bonding an sealing of mirrors

BUILDING MATERIALS

- ABS
- Concrete
- Pumice
- Gypsum plasterboard
- Glass
- Wooden materials
- H-PVC
- Ceramics
- Copper
- Masonry, clinker brick
- Metals
- Natural stone
- Polycarbonate and PMMA
- Polystyrene hard foam
- Aerated concrete
- Plaster
- Brick

CHARACTERISTICS

- EN 15651 - Part 1: F EXT-INT (class 20 HM)
- EN 15651 - Part 3: S (class XS1)
- EN 15651 - Part 4: PW-INT
- LEED® IEQ-credits 4.1 (Indoor Environmental Quality) adhesives and sealants

ADVANTAGES

- The extremely high initial adhesion of 110 kg/m² makes it possible to attach lots of components without the need for additional fixing, and thus reduces the amount of time required.
- The MS polymer® allows for an elastic adhesion for vibration-dampening and stress-compensating connections for demanding applications.
- KD is almost odour-free and therefore particularly suitable for closed rooms.
- Non-corrosive, thus can be used on copper and zinc plated surfaces for maximum flexibility in application.

APPLICATIONS

Stress-compensating bonding and sealing of:

- Standard mirrors
- Vibrating constructions
- Metal profiles
- Joints and seams in ventilated constructions
- Insulation material, ledges, panels and cladding
- Kitchens and built-in furniture
- Stair treads and window sills
- Floor joints, connection joints in car body, vehicle construction, metal construction and ship building

FUNCTION / ASSEMBLY

- Chemical base: One-component hybrid polymer
- Processing temperature +5 °C to +35 °C
- Setting time approx. 5 minutes
- High initial adhesion of 110 kg/m²
- Curing: approx. 3 mm per day
- High elasticity of 20 %
- Shore A 50 ± 5
- Temperature resistance: -40 °C to +90 °C
- Also bonds on a moist base material
- Prevents mould build-up, even without additional ingredients
- Suitable for bonding non-absorbent components (see TDS)
- Can be painted (see TDS)
- Free from solvents and silicone
- Waterproof and Sea water resistant
- Very good resistance to weather, age and UV

TECHNICAL DATA

Item	Art.-No.	Contents		Type of packaging	Colour	Sales unit
		[ml]	[g]			
KD WHITE 290ML	059389	290	420	Cartridge	white	12
KD GREY 290ML (DE/EN)	503318	290	420	Cartridge	grey	12
KD BLACK 290ML (DE/EN)	503319	290	420	Cartridge	black	12

The transparent hybrid polymer for discreet adhesive and sealant joints for interior and exterior use.



Bonding and sealing aluminium profiles



For invisible glued and sealed joints

BUILDING MATERIALS

- ABS
- Concrete
- Stainless steel
- Anodised layer
- Tiles
- Glass, glazed surfaces
- Wooden materials
- H-PVC
- Ceramics
- Copper, brass
- Masonry, Clinker brick
- Metals
- Polycarbonate and PMMA
- Polystyrene hard foam
- Steel
- Brick
- Zinc

CERTIFICATES

- EN 15651 - Part 1: F INT
- LEED® IEQ-credits 4.1 (Indoor Environmental Quality) adhesives and sealants

ADVANTAGES

- The transparent formula is perfect for discreet adhesion and sealing and guarantees the optimum appearance.
- The high initial adhesion of 70 kg/m² allows many components to be attached without additional fixing.
- Thanks to the high elasticity of 20%, KD transparent is also ideally suited for high-stress expansion joints and guarantees permanent sealing at all times.
- Non-corrosive, thus can be used on copper and zinc plated surfaces for maximum flexibility in application.
- KD clear is almost odour-free and therefore particularly suitable for closed rooms.

APPLICATIONS

Stress-compensating bonding and sealing of:

- Glass and other transparent materials, preferably in interior areas
- Insulation material, ledges, panels and cladding
- Kitchens and built-in furniture
- Constructions in timber, bodywork, metal, container and shipbuilding industries

FUNCTIONING

- Chemical Base: One-component hybrid polymer
- Very easy to apply
- Prevents the formation of mould, even without additional active substances
- Skin formation time: approx. 10 minutes
- High initial adhesion of 50 kg/m²
- Cures after approx. 3 mm/24h
- Processing temperature: +5 °C to +35 °C
- High elasticity of 20%
- Shore A 38 ± 5
- Also bonds on a moist base material
- Temperature resistance: -40 °C to +90 °C
- Compatible with paint; paintable
- Natural stone may discolour
- Free from solvents, isocyanat- and silicon

TECHNICAL DATA

Item	Art.-No.	Contents [ml]	Contents [g]	Type of packaging	Colour	Sales unit [pcs]
KD CRYSTAL CLEAR 290ML (DE/EN)	503317	290	300	Cartridge	crystal clear	12

The flexible high-performance adhesive with very high initial adhesion to many absorbent and non-absorbent substrates



Bonding of wall cladding



Bonding of mirrors

BUILDING MATERIALS

- ABS
- Concrete
- Stainless steel
- Anodised layer
- Natural stone, marble
- Glass, glazed surfaces
- Wooden materials
- H-PVC
- Ceramics
- Copper, brass
- Masonry, clinker brick, tiles
- Metals
- Polycarbonate and PMMA
- Polystyrene hard foam
- HPL panels
- Brick
- Zinc

TEST CERTIFICATE

- EMICODE EC 1 Plus - very low emission
- French VOC emission class A+

13

Adhesives

ADVANTAGES

- The extremely high initial adhesion of > 290 kg/m² makes it possible to attach lots of components without the need for additional fixings, and thus reduces the amount of time required.
- The high final tensile strength of 2.2 N/mm² guarantees really safe glued connections.
- The MS Polymer® enables elastic bonding for vibration-dampening and stress-compensating connections in challenging applications.
- HTM is practically odourless and is therefore ideal for use in confined spaces.
- It is non-corrosive and can therefore be used on aluminium, copper and zinc-plated surfaces, making it particularly flexible.

APPLICATIONS

- Stress compensating bonding of:
- Standard mirrors
 - Vibrating constructions
 - Metal profiles
 - Seams in ventilation construction
 - Insulation material, ledges, panels and cladding
 - Kitchens and built-in furniture
 - Stair treads and window sills
 - Different types of stone
 - Also of non-absorbent materials (see technical data sheet)
 - A wide variety of materials in container, body, metal, ship and vehicle construction

FUNCTIONALITY















- Chemical base: One-component hybrid polymer
- Colour: White
- Processing temperature +5 °C to +40 °C
- Processing time of around 10 minutes
- Hardening time of 2-3 mm/24 h
- Extremely high initial adhesion > 290 kg/m²
- Shore A 56
- Temperature resistance: -40 °C to +90 °C
- Adhesive, even on a damp base
- Suitable for bonding non-absorbent components (see TDS)
- Can be painted (see TDS)
- Free from solvents, MDI and silicone
- Very good resistance to weather, ageing and UV

TECHNICAL DATA

Item	Art.-No.	Contents		Type of packaging	Colour	Sales unit	
		[ml]	[g]			[pcs]	
HTM WH 290 (DE/EN)	541712	290	450	Cartridge	white	12	
V-Nozzle Express Cement	524315	–	–	–	–	1	



14 Drills and bits

	Page
Hammer drill bit Quattric II 	550
Hammer drill bit SDS Plus II Pointer 	553
Masonry drill bit Pointer M 	557
Hammer drill bit SDS Max II / SDS Max IV 	558
Hollow drill bit FHD 	561
Stone drill bit D-S 	562
Premium chisel FCP 	563
Standard chisel 	564
Profi-bit FPB 	565
Diamond-bit FDB 	566
Maxx-bit FMB 	567
Bit holder FBH 	568
Bit-Set 	569
Accessories for impact driver 	570



The expert for the best performance in reinforced concrete



ADVANTAGES

- Carbide head (up to \varnothing 10 mm) for long service life.
- Power shoulders for improved breakup performance in concrete.
- Massive main cutting edges for quick drilling progress.
- Reinforcement chamfers prevent jamming in the reinforcement.
- Centring tip for simple positioning.
- Wear mark for simple recognition of wear limit in accordance with PGM.
- Two-piece spiral for quick drilling progress and increased service life.

APPLICATIONS

To create approval-compliant drill holes in:

- Reinforced concrete
- Concrete
- Solid brick
- Sand-lime brick

Also suitable for:

- Natural stone

CHARACTERISTICS



TECHNICAL DATA



Hammer drill **Quattric II**



Detail:
Top of drill Quattric II
Ø 5 - 10 mm



Detail:
Top of drill Quattric II
Ø 11 - 16 mm



Detail:
Top of drill Quattric II
17 - 32 mm

Item	Art.-No.	Drill hole diameter d_0 [mm]	Working length [mm]	Total length [mm]	Type of packaging	Contents	Sales unit [pcs]
Quattric II 5/50/115	549973	5	50	115	Plastic clip	1	1
Quattric II 5/100/165	549974	5	100	165	Plastic clip	1	1
Quattric II 5/150/215	544214	5	150	215	Plastic clip	1	1
Quattric II 5,5/50/115	549971	5,5	50	115	Plastic clip	1	1
Quattric II 5,5/100/165	549972	5,5	100	165	Plastic clip	1	1
Quattric II 6/50/115	549983	6	50	115	Plastic clip	1	1
Quattric II 6/100/165	549979	6	100	165	Plastic clip	1	1
Quattric II 6/150/215	549981	6	150	215	Plastic clip	1	1
Quattric II 6/200/265	549985	6	200	265	Plastic clip	1	1
Quattric II 6/250/315	549986	6	250	315	Plastic clip	1	1
Quattric II 6,5/100/165	549975	6,5	100	165	Plastic clip	1	1
Quattric II 6,5/150/215	549976	6,5	150	215	Plastic clip	1	1
Quattric II 6,5/200/265	549977	6,5	200	265	Plastic clip	1	1
Quattric II 6,5/250/315	549978	6,5	250	315	Plastic clip	1	1
Quattric II 8/50/115	549993	8	50	115	Plastic clip	1	1
Quattric II 8/100/165	549988	8	100	165	Plastic clip	1	1
Quattric II 8/150/215	549990	8	150	215	Plastic clip	1	1
Quattric II 8/200/265	549994	8	200	265	Plastic clip	1	1
Quattric II 8/250/315	549992	8	250	315	Plastic clip	1	1
Quattric II 8/300/365	549995	8	300	365	Plastic clip	1	1
Quattric II 8/400/465	549996	8	400	465	Plastic clip	1	1
Quattric II 10/50/115	549928	10	50	115	Plastic clip	1	1
Quattric II 10/100/165	549922	10	100	165	Plastic clip	1	1
Quattric II 10/150/215	549925	10	150	215	Plastic clip	1	1
Quattric II 10/200/265	549929	10	200	265	Plastic clip	1	1
Quattric II 10/250/315	549927	10	250	315	Plastic clip	1	1
Quattric II 10/300/365	544224	10	300	365	Plastic clip	1	1
Quattric II 10/390/455	549930	10	390	455	Plastic clip	1	1
Quattric II 10/540/600	544222	10	540	600	Plastic clip	1	1
Quattric II 12/110/160	549932	12	110	160	Plastic clip	1	1
Quattric II 12/160/210	549936	12	160	210	Plastic clip	1	1
Quattric II 12/210/260	549934	12	210	260	Plastic clip	1	1
Quattric II 12/260/310	549939	12	260	310	Plastic clip	1	1
Quattric II 12/400/450	549935	12	400	450	Plastic clip	1	1
Quattric II 12/550/600	544213	12	550	600	Plastic clip	1	1
Quattric II 12/950/1000	549931	12	950	1000	Plastic clip	1	1
Quattric II 14/110/160	549941	14	110	160	Plastic clip	1	1
Quattric II 14/160/210	549944	14	160	210	Plastic clip	1	1
Quattric II 14/210/260	549942	14	210	260	Plastic clip	1	1
Quattric II 14/260/310	549945	14	260	310	Plastic clip	1	1
Quattric II 14/400/450	549943	14	400	450	Plastic clip	1	1
Quattric II 14/550/600	544223	14	550	600	Plastic clip	1	1
Quattric II 14/950/1000	549940	14	950	1000	Plastic clip	1	1
Quattric II 15/110/160	549946	15	110	160	Plastic clip	1	1
Quattric II 15/160/210	549947	15	160	210	Plastic clip	1	1
Quattric II 15/210/260	544215	15	210	260	Plastic clip	1	1
Quattric II 16/110/160	549950	16	110	160	Plastic clip	1	1
Quattric II 16/160/210	549951	16	160	210	Plastic clip	1	1
Quattric II 16/210/260	549952	16	210	260	Plastic clip	1	1
Quattric II 16/260/310	549953	16	260	310	Plastic clip	1	1
Quattric II 16/400/450	549954	16	400	450	Plastic clip	1	1

TECHNICAL DATA



Hammer drill **Quattric II**



Detail:
Top of drill Quattric II
Ø 5 - 10 mm



Detail:
Top of drill Quattric II
Ø 11 - 16 mm



Detail:
Top of drill Quattric II
17 - 32 mm

Item	Art.-No.	Drill hole diameter d_0 [mm]	Working length [mm]	Total length [mm]	Type of packaging	Contents	Sales unit [pcs]
Quattric II 16/550/600	549955	16	550	600	Plastic clip	1	1
Quattric II 16/950/1000	549948	16	950	1000	Plastic clip	1	1
Quattric II 18/200/250	549956	18	200	250	Plastic tube	1	1
Quattric II 18/400/450	549957	18	400	450	Plastic tube	1	1
Quattric II 20/200/250	549958	20	200	250	Plastic tube	1	1
Quattric II 20/400/450	549959	20	400	450	Plastic tube	1	1
Quattric II 22/200/250	549960	22	200	250	Plastic tube	1	1
Quattric II 22/400/450	549961	22	400	450	Plastic tube	1	1
Quattric II 24/200/250	549962	24	200	250	Plastic tube	1	1
Quattric II 24/400/450	549963	24	400	450	Plastic tube	1	1
Quattric II 25/200/250	549964	25	200	250	Plastic tube	1	1
Quattric II 25/400/450	549965	25	400	450	Plastic tube	1	1
Quattric II 28/200/250	549966	28	200	250	Plastic tube	1	1
Quattric II 28/400/450	549967	28	400	450	Plastic tube	1	1
Quattric II 30/200/250	549968	30	200	250	Plastic tube	1	1
Quattric II 30/400/450	549969	30	400	450	Plastic tube	1	1
Quattric II 32/400/450	549970	32	400	450	Plastic tube	1	1
Quattric II 6/50/115 XP5	549984	6	50	115	Plastic box	5	1
Quattric II 6/100/165 XP5	544225	6	100	165	Plastic box	5	1
Quattric II 6/150/215 XP5	549982	6	150	215	Plastic box	5	1
Quattric II 6,5/100/165 XP5	544217	6,5	100	165	Plastic box	5	1
Quattric II 6,5/150/215 XP5	544218	6,5	150	215	Plastic box	5	1
Quattric II 6,5/200/265 XP5	544219	6,5	200	265	Plastic box	5	1
Quattric II 8/100/165 XP5	549989	8	100	165	Plastic box	5	1
Quattric II 8/150/215 XP5	549991	8	150	215	Plastic box	5	1
Quattric II 10/100/165 XP5	549924	10	100	165	Plastic box	5	1
Quattric II 10/150/215 XP5	549926	10	150	215	Plastic box	5	1
Quattric II 12/110/160 XP5	549933	12	110	160	Plastic box	5	1
Quattric II 12/160/210 XP5	549937	12	160	210	Plastic box	5	1
Quattric II 12/210/260 XP5	549938	12	210	260	Plastic box	5	1
Quattric II 14/110/160 XP5	544220	14	110	160	Plastic box	5	1
Quattric II 14/160/210 XP5	544221	14	160	210	Plastic box	5	1
Quattric II 6/100/165 XP10	549980	6	100	165	Plastic box	10	1
Quattric II 8/100/165 XP10	544216	8	100	165	Plastic box	10	1
Quattric II 10/100/165 XP10	549923	10	100	165	Plastic box	10	1

The two-flute cutter is setting new standards when it comes to drilling speed



ADVANTAGES

- The optimised drill geometry allows for rapid drilling progress, reduced wear and tear, and less effort.
- The centring tip allows for easy and precise drilling and prevents slipping on smooth surfaces.
- The "Power Breakers" on the drill bit head have a "destructive effect". They create micro-cracks in the material and achieve a noticeably improved drilling speed.
- The larger reinforcement chamfers (+35%) guarantee that the drill acts in the best possible way when it hits concrete reinforcements. This considerably reduces the risk of problems caused by drill jamming.
- The new Vario KVS helix offers further benefits: The narrow crown width behind the drill bit head reduces friction and ensures a more powerful transfer of energy during impact drilling. The improved helix allows for an ideal transportation of the drill residue. The spiral shape increases stability and, with it, the break resistance.

APPLICATIONS

To create approval-compliant drill holes in:

- Concrete
- Solid brick
- Sand-lime brick

Also suitable for:

- Natural stone

CHARACTERISTICS



TECHNICAL DATA



Hammer drill bit **SDS Plus II Pointer**

Detail: top of drill

Item	Art.-No.	Drill hole diameter d_0 [mm]	Working length [mm]	Total length l [mm]	Type of packaging	Contents [pcs]	Sales unit [pcs]
SDS Plus II 4/50/110	531753	4	50	110	Plastic clip	1	1
SDS Plus II 4/100/160	531754	4	100	160	Plastic clip	1	1
SDS Plus II 5/50/110	531755	5	50	110	Plastic clip	1	1
SDS Plus II 5/100/160	531756	5	100	160	Plastic clip	1	1
SDS Plus II 5/150/210	531757	5	150	210	Plastic clip	1	1
SDS Plus II 5/250/310	531759	5	250	310	Plastic clip	1	1
SDS Plus II 5,5/100/160	531761	5,5	100	160	Plastic clip	1	1
SDS Plus II 5,5/150/210	531762	5,5	150	210	Plastic clip	1	1
SDS Plus II 5,5/250/310	531763	5,5	250	310	Plastic clip	1	1
SDS Plus II 6/50/110	531765	6	50	110	Plastic clip	1	1
SDS Plus II 6/100/160	531766	6	100	160	Plastic clip	1	1
SDS Plus II 6/150/210	531767	6	150	210	Plastic clip	1	1
SDS Plus II 6/200/260	531768	6	200	260	Plastic clip	1	1
SDS Plus II 6/250/310	531769	6	250	310	Plastic clip	1	1
SDS Plus II 6,5/50/110	531770	6,5	50	110	Plastic clip	1	1
SDS Plus II 6,5/100/160	531771	6,5	100	160	Plastic clip	1	1
SDS Plus II 6,5/150/210	531772	6,5	150	210	Plastic clip	1	1
SDS Plus II 6,5/200/260	531773	6,5	200	260	Plastic clip	1	1
SDS Plus II 6,5/250/310	531774	6,5	250	310	Plastic clip	1	1
SDS Plus II 7/50/110	531775	7	50	110	Plastic clip	1	1
SDS Plus II 7/100/160	531776	7	100	160	Plastic clip	1	1
SDS Plus II 7/150/210	531777	7	150	210	Plastic clip	1	1
SDS Plus II 7/200/250	531778	7	200	250	Plastic clip	1	1
SDS Plus II 8/50/110	531779	8	50	110	Plastic clip	1	1
SDS Plus II 8/100/160	531780	8	100	160	Plastic clip	1	1
SDS Plus II 8/150/210	531781	8	150	210	Plastic clip	1	1
SDS Plus II 8/200/260	531782	8	200	260	Plastic clip	1	1
SDS Plus II 8/250/310	531783	8	250	310	Plastic clip	1	1
SDS Plus II 8/350/400	531784	8	350	400	Plastic clip	1	1
SDS Plus II 8/400/460	531785	8	400	460	Plastic clip	1	1
SDS Plus II 8/550/600	531786	8	550	600	Plastic clip	1	1
SDS Plus II 9/100/160	531788	9	100	160	Plastic clip	1	1
SDS Plus II 9/150/210	531789	9	150	210	Plastic clip	1	1
SDS Plus II 9,5/100/160	531790	9,5	100	160	Plastic clip	1	1
SDS Plus II 10/50/110	531791	10	50	110	Plastic clip	1	1
SDS Plus II 10/100/160	531792	10	100	160	Plastic clip	1	1
SDS Plus II 10/150/210	531793	10	150	210	Plastic clip	1	1
SDS Plus II 10/200/260	531794	10	200	260	Plastic clip	1	1
SDS Plus II 10/250/310	531795	10	250	310	Plastic clip	1	1
SDS Plus II 10/300/350	531796	10	300	350	Plastic clip	1	1
SDS Plus II 10/400/450	531797	10	400	450	Plastic clip	1	1
SDS Plus II 10/550/600	531798	10	550	600	Plastic clip	1	1
SDS Plus II 10/750/800	531799	10	750	800	Plastic clip	1	1
SDS Plus II 10/950/1000	531800	10	950	1000	Plastic clip	1	1
SDS Plus II 11/100/160	531801	11	100	160	Plastic clip	1	1
SDS Plus II 11/250/310	531802	11	250	310	Plastic clip	1	1
SDS Plus II 12/100/160	531803	12	100	160	Plastic clip	1	1
SDS Plus II 12/150/210	531804	12	150	210	Plastic clip	1	1
SDS Plus II 12/200/260	531805	12	200	260	Plastic clip	1	1
SDS Plus II 12/250/310	531806	12	250	310	Plastic clip	1	1
SDS Plus II 12/300/360	531807	12	300	360	Plastic clip	1	1
SDS Plus II 12/400/450	531808	12	400	450	Plastic clip	1	1
SDS Plus II 12/550/600	531809	12	550	600	Plastic clip	1	1

TECHNICAL DATA



Hammer drill bit **SDS Plus II Pointer**

Detail: top of drill

Item	Art.-No.	Drill hole diameter d_0 [mm]	Working length [mm]	Total length l [mm]	Type of packaging	Contents [pcs]	Sales unit [pcs]
SDS Plus II 12/950/1000	531810	12	950	1000	Plastic clip	1	1
SDS Plus II 13/100/160	531811	13	100	160	Plastic clip	1	1
SDS Plus II 13/150/210	531812	13	150	210	Plastic clip	1	1
SDS Plus II 13/200/260	531813	13	200	260	Plastic clip	1	1
SDS Plus II 13/250/310	531814	13	250	310	Plastic clip	1	1
SDS Plus II 14/100/160	531815	14	100	160	Plastic clip	1	1
SDS Plus II 14/150/210	531816	14	150	210	Plastic clip	1	1
SDS Plus II 14/200/260	531817	14	200	260	Plastic clip	1	1
SDS Plus II 14/250/310	531818	14	250	310	Plastic clip	1	1
SDS Plus II 14/400/450	531819	14	400	450	Plastic clip	1	1
SDS Plus II 14/550/600	531820	14	550	600	Plastic clip	1	1
SDS Plus II 14/950/1000	531821	14	950	1000	Plastic clip	1	1
SDS Plus II 15/100/160	531822	15	100	160	Plastic clip	1	1
SDS Plus II 15/150/210	531823	15	150	210	Plastic clip	1	1
SDS Plus II 15/200/260	531824	15	200	260	Plastic clip	1	1
SDS Plus II 15/400/450	531825	15	400	450	Plastic clip	1	1
SDS Plus II 16/100/160	531826	16	100	160	Plastic clip	1	1
SDS Plus II 16/150/210	531827	16	150	210	Plastic clip	1	1
SDS Plus II 16/200/260	531828	16	200	260	Plastic clip	1	1
SDS Plus II 16/250/310	531829	16	250	310	Plastic clip	1	1
SDS Plus II 16/400/450	531830	16	400	450	Plastic clip	1	1
SDS Plus II 16/550/600	531831	16	550	600	Plastic clip	1	1
SDS Plus II 16/750/800	531832	16	750	800	Plastic clip	1	1
SDS Plus II 16/950/1000	531833	16	950	1000	Plastic clip	1	1
SDS Plus II 17/150/210	531834	17	150	210	Plastic clip	1	1
SDS Plus II 17/400/450	531835	17	400	450	Plastic clip	1	1
SDS Plus II 18/150/200	531836	18	150	200	Plastic clip	1	1
SDS Plus II 18/250/300	531837	18	250	300	Plastic clip	1	1
SDS Plus II 18/400/450	531838	18	400	450	Plastic clip	1	1
SDS Plus II 18/550/600	531839	18	550	600	Plastic clip	1	1
SDS Plus II 18/950/1000	531840	18	950	1000	Plastic clip	1	1
SDS Plus II 19/150/200	531841	19	150	200	Plastic clip	1	1
SDS Plus II 19/400/450	531842	19	400	450	Plastic clip	1	1
SDS Plus II 20/150/200	531843	20	150	200	Plastic clip	1	1
SDS Plus II 20/250/300	531844	20	250	300	Plastic clip	1	1
SDS Plus II 20/400/450	531845	20	400	450	Plastic clip	1	1
SDS Plus II 20/550/600	531846	20	550	600	Plastic clip	1	1
SDS Plus II 20/950/1000	531847	20	950	1000	Plastic clip	1	1
SDS Plus II 22/200/250	531849	22	200	250	Plastic clip	1	1
SDS Plus II 22/400/450	531850	22	400	450	Plastic clip	1	1
SDS Plus II 22/550/600	531851	22	550	600	Plastic clip	1	1
SDS Plus II 22/950/1000	531852	22	950	1000	Plastic clip	1	1
SDS Plus II 24/200/250	531853	24	200	250	Plastic clip	1	1
SDS Plus II 24/400/450	531854	24	400	450	Plastic clip	1	1
SDS Plus II 25/200/250	531855	25	200	250	Plastic clip	1	1
SDS Plus II 25/400/450	531856	25	400	450	Plastic clip	1	1
SDS Plus II 25/550/600	531857	25	550	600	Plastic clip	1	1
SDS Plus II 26/200/250	531858	26	200	250	Plastic clip	1	1
SDS Plus II 26/400/450	531859	26	400	450	Plastic clip	1	1
SDS Plus II 6/50/110 QP	531860	6	50	110	Plastic box	10	1
SDS Plus II 6/100/160 QP	531861	6	100	160	Plastic box	10	1
SDS Plus II 8/100/160 QP	531862	8	100	160	Plastic box	10	1
SDS Plus II 8/150/210 QP	531863	8	150	210	Plastic box	10	1

TECHNICAL DATA



Hammer drill bit **SDS Plus II Pointer**

Detail: top of drill

Item	Art.-No.	Drill hole diameter d_0 [mm]	Working length [mm]	Total length l [mm]	Type of packaging	Contents [pcs]	Sales unit [pcs]
SDS Plus II 10/100/160 QP	531864	10	100	160	Plastic box	10	1
SDS Plus II 10/150/210 QP	531865	10	150	210	Plastic box	10	1
SDS Plus II 10/200/260 QP	531866	10	200	260	Plastic box	10	1
SDS Plus II 10/250/310 QP	531867	10	250	310	Plastic box	10	1
SDS Plus II 12/100/160 QP	531868	12	100	160	Plastic box	10	1
SDS Plus II 12/150/210 QP	531869	12	150	210	Plastic box	10	1
SDS Plus II 12/200/260 QP	531870	12	200	260	Plastic box	10	1

The perfect drill bit for all perforated building materials



ADVANTAGES

- Shortened SDS-Plus shank reduces the impact of the machine on the drill and prevents possible damage to the substrate (it is recommended to use the drill bit without impact).
- Precise and accurate drill holes without damage to the substrate thanks to shortened SDS-Plus shank to guarantee correct fixing with increased load capacities in all types of perforated building materials.
- Diamond sharpened carbide tip with advanced cutting edges ensure fast and safe drilling progress in different materials.
- Large spiral flutes for optimal removal of dust.

APPLICATIONS

To create drill holes in:

- Hollow bricks
- Aerated concrete
- Perforated sand-lime bricks

Ideal for:

- Frame-fixings or ETICS systems e.g. SXRL, FIS HK, fischer Thermax, EWI and VBS-M

CHARACTERISTICS



TECHNICAL DATA



Masonry drill bit **Pointer M**

Item	Art.-No.	Drill hole diameter d_0 [mm]	Working length [mm]	Total length [mm]	Type of packaging	Contents [pcs]	Sales unit [pcs]
Pointer M 6/350/410	546204	6	350	410	Pouch	1	1
Pointer M 8/200/260	544382	8	200	260	Pouch	1	1
Pointer M 10/200/260	543630	10	200	260	Pouch	1	1
Pointer M 12/200/260	543631	12	200	260	Pouch	1	1
Pointer M 14/200/260	543632	14	200	260	Pouch	1	1
Pointer M 16/200/260	543633	16	200	260	Pouch	1	1
Pointer M 16/100/400	543634	16	100	400	Pouch	1	1
Pointer M 18/350/410	546205	18	350	410	Plastic tube	1	1
Pointer M 20/100/400	543635	20	100	400	Plastic tube	1	1
Pointer M 22/350/410	546206	22	350	410	Plastic tube	1	1

The hammer drill bits with SDS Max drill chuck



ADVANTAGES

- The SDS Max drill chuck ensures optimum transfer of force and allows for quick drilling progress for large volume drill holes.
- The drill bit head with four cutting edges prevents jamming in the concrete reinforcement.
- The quadruple flute reliably transports the drilling dust from the drill hole, thus reducing wear.
- The core-reinforced flute ensures maximum transfer of energy, and guarantees a low-vibration drilling.
- The PGM®-compliant cutting element guarantees perfect-fit drill holes to fulfil the highest safety requirements.

APPLICATIONS

To create approval-compliant drill holes in:

- Reinforced concrete (SDS Max IV)
- Concrete
- Solid brick
- Sand-lime brick

Also suitable for:

- Natural stone

CHARACTERISTICS



TECHNICAL DATA



Hammerdrill **SDS Max II and IV**



Detail:
Top of drill SDS Max II
Ø 12 - 15 mm



Detail:
Top of drill SDS Max IV
from Ø 16 mm

Item	Art.-No.	Drill hole diameter d_0 [mm]	Working length [mm]	Total length l [mm]	Type of packaging	Contents [pcs]	Sales unit [pcs]
SDS Max II 12/200/340	504188	12	200	340	Plastic tube	1	1
SDS Max II 12/400/540	504189	12	400	540	Plastic tube	1	1
SDS Max II 12/800/920	098278	12	800	920	Plastic tube	1	1
SDS Max II 14/200/340	504192	14	200	340	Plastic tube	1	1
SDS Max II 14/400/540	504194	14	400	540	Plastic tube	1	1
SDS Max II 14/1000/1120	098279 ¹⁾	14	1000	1120	Plastic tube	1	1
SDS Max II 15/200/340	504196	15	200	340	Plastic tube	1	1
SDS Max IV 15/400/540	524562	15	400	540	Plastic tube	1	1
SDS Max IV 16/200/340	504198	16	200	340	Plastic tube	1	1
SDS Max IV 16/400/540	504199	16	400	540	Plastic tube	1	1
SDS Max IV 16/800/920	504200	16	800	920	Plastic tube	1	1
SDS Max IV 16/1200/1320	504206	16	1200	1320	Plastic tube	1	1
SDS Max IV 18/200/340	504207	18	200	340	Plastic tube	1	1
SDS Max IV 18/400/540	504208	18	400	540	Plastic tube	1	1
SDS Max IV 18/800/920	504209	18	800	920	Plastic tube	1	1
SDS Max IV 18/1200/1320	504213	18	1200	1320	Plastic tube	1	1
SDS Max IV 20/200/320	504214	20	200	320	Plastic tube	1	1
SDS Max IV 20/400/520	504217	20	400	520	Plastic tube	1	1
SDS Max IV 20/800/920	504222	20	800	920	Plastic tube	1	1
SDS Max IV 20/1200/1320	504223	20	1200	1320	Plastic tube	1	1
SDS Max IV 22/200/320	504224	22	200	320	Tube	1	1
SDS Max IV 22/400/520	504225	22	400	520	Plastic tube	1	1
SDS Max IV 22/800/920	504226	22	800	920	Plastic tube	1	1
SDS Max IV 24/200/320	504228	24	200	320	Plastic tube	1	1
SDS Max IV 24/400/520	504229	24	400	520	Plastic tube	1	1
SDS Max IV 25/200/320	504235	25	200	320	Plastic tube	1	1
SDS Max IV 25/400/520	504236	25	400	520	Plastic tube	1	1
SDS Max IV 25/800/920	504237	25	800	920	Plastic tube	1	1
SDS Max IV 25/1200/1320	504238	25	1200	1320	Plastic tube	1	1
SDS Max IV 25/2000/2120	098287	25	2000	2120	Plastic tube	1	1
SDS Max IV 28/250/370	504240	28	250	370	Plastic tube	1	1
SDS Max IV 28/450/570	504241	28	450	570	Plastic tube	1	1
SDS Max IV 28/550/670	504242	28	550	670	Plastic tube	1	1
SDS Max IV 28/800/920	504243	28	800	920	Plastic tube	1	1
SDS Max IV 30/250/370	504245	30	250	370	Plastic tube	1	1
SDS Max IV 30/450/570	504246	30	450	570	Plastic tube	1	1
SDS Max IV 30/800/920	057779	30	800	920	Plastic tube	1	1
SDS Max IV 30/1230/1350	040187 ¹⁾	30	1210	1350	Plastic tube	1	1
SDS Max IV 30/1620/1740	040188 ¹⁾	30	1620	1740	Plastic tube	1	1
SDS Max IV 30/2020/2140	040189 ¹⁾	30	2000	2140	Plastic tube	1	1
SDS Max IV 32/450/570	504248	32	450	570	Plastic tube	1	1
SDS Max IV 32/800/920	504249	32	800	920	Plastic tube	1	1
SDS Max IV 35/250/370	504251	35	250	370	Plastic tube	1	1
SDS Max IV 35/450/570	504256	35	450	570	Plastic tube	1	1
SDS Max IV 35/550/670	504257	35	550	670	Plastic tube	1	1
SDS Max IV 35/800/920	504258	35	800	920	Plastic tube	1	1
SDS Max IV 35/1200/1320	504259	35	1200	1320	Plastic tube	1	1
SDS Max IV 35/1620/1740	040191	35	1620	1740	Plastic tube	1	1
SDS Max IV 35/2020/2140	040192	35	2000	2140	Plastic tube	1	1
SDS Max IV 38/450/570	504268	38	450	570	Plastic tube	1	1
SDS Max IV 40/250/370	504269	40	250	370	Plastic tube	1	1

1) delivery on request

TECHNICAL DATA

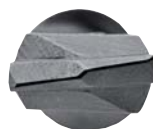

Detail:
Top of drill SDS Max II
Ø 12 - 15 mm



Detail:
Top of drill SDS Max IV
from Ø 16 mm

Hammerdrill **SDS Max II and IV**

Item	Art.-No.	Drill hole diameter d_0 [mm]	Working length [mm]	Total length l [mm]	Type of packaging	Contents [pcs]	Sales unit [pcs]
SDS Max IV 40/450/570	504270	40	450	570	Plastic tube	1	1
SDS Max IV 40/800/920	504271	40	800	920	Plastic tube	1	1

1) delivery on request

Hollow drill bit for drilling with low dust as well as for efficient and approved anchoring



ADVANTAGES

- Drilling and drill hole cleaning in one single step saves the normal cleaning of chemical and mechanical anchoring when the hollow drill bit is regulated by their respective approvals. This saves up to 55% of the complete drill hole creation process.
- The drill hole will be cleaned thoroughly guaranteeing a secure fixing (drilling dust reduces performance of fixing materials).
- Reducing the drill dust prevents jamming when drilling therefore provides a faster and frictionless drilling progress.
- Immediate extraction of drilling dust at the drill tip for a clean and healthy work place.
- Centering tip allows for accurate positioning on uneven surfaces reducing slip.

APPLICATIONS

To create approval-compliant drill holes in:

- Reinforced concrete
- Concrete

Also suitable for:

- Solid brick
- Solid sand-lime brick
- Natural stone

CHARACTERISTICS



TECHNICAL DATA



Hollow drill bit FHD



Detail:
Top of drill FHD
Ø 12 - 14 mm



Detail:
Top of drill FHD
Ø 16 - 18 mm
Top of drill FHD Max
Ø 16 - 35 mm

Item	Art.-No.	Drill hole diameter d_0 [mm]	Working length [mm]	Total length [mm]	Type of packaging	Contents	Sales unit [pcs]
FHD 12/200/330	546597	12	200	330	Plastic clip	1	1
FHD 14/250/380	546598	14	250	380	Plastic clip	1	1
FHD 16/250/380	546599	16	250	380	Plastic clip	1	1
FHD 18/320/450	546600	18	320	450	Plastic clip	1	1
FHD Max 16/400/620	546601	16	400	620	Plastic clip	1	1
FHD Max 18/400/620	546602	18	400	620	Plastic clip	1	1
FHD Max 20/400/620	546603	20	400	620	Plastic clip	1	1
FHD Max 24/400/620	546604	24	400	620	Plastic clip	1	1
FHD Max 28/600/820	546605	28	600	820	Plastic clip	1	1
FHD Max 30/600/820	546606	30	600	820	Plastic clip	1	1
FHD Max 35/650/870	546607	35	650	870	Plastic clip	1	1

Universal masonry drill bit for impact and rotary drilling in masonry and natural stone



ADVANTAGES

- 130° carbide cutting edge for long service life, very heat resistant.
- Robust version in accordance with DIN 8039, roll forged.
- Optimum drill dust removal through special spiral geometry.
- Suitable for rotary and impact drilling.

APPLICATIONS

- For regular drilling especially in stone and masonry

CHARACTERISTICS



TECHNICAL DATA



Stone drill bit D-S

Item	Art.-No.	Drill hole diameter d_0 [mm]	Working length [mm]	Total length l [mm]	Type of packaging	Contents [pcs]	Sales unit [pcs]
D-S HM 3,0 x 30/60	542976	3	30	60	Pouch	1	1
D-S HM 4,0 x 38/75	542977	4	38	75	Pouch	1	1
D-S HM 5,0 x 44/85	542978	5	44	85	Pouch	1	1
D-S HM 6,0 x 54/100	542979	6	54	100	Pouch	1	1
D-S HM 6,0 x 135/200	551390	6	135	200	Pouch	1	1
D-S HM 7,0 x 54/100	542980	7	54	100	Pouch	1	1
D-S HM 8,0 x 67/120	542981	8	67	120	Pouch	1	1
D-S HM 8,0 x 135/200	542991	8	135	200	Pouch	1	1
D-S HM 10,0 x 67/120	542982	10	67	120	Pouch	1	1
D-S HM 10,0 x 135/200	542992	10	135	200	Pouch	1	1
D-S HM 12,0 x 85/150	542983	12	85	150	Pouch	1	1
D-S HM 12,0 x 135/200	542993	12	135	200	Pouch	1	1
D-S HM 13,0 x 85/150	542984	13	85	150	Pouch	1	1
D-S HM 14,0 x 85/150	542985	14	85	150	Pouch	1	1
D-S HM 15,0 x 85/150	542986	15	85	150	Pouch	1	1
D-S HM 16,0 x 85/150	542987	16	85	150	Pouch	1	1
D-S HM 18,0 x 100/160	542988	18	100	160	Pouch	1	1
D-S HM 20,0 x 100/160	542989	20	100	160	Pouch	1	1
D-S Set 4-10mm 5pcs P	543025	4-5-6-8-10	–	–	Plastic cassette	5	1
D-S Set 3-10mm 8pcs P	543027	3-10	–	–	Plastic cassette	8	1

Premium Chisel with SDS Plus and SDS Max shank for maximum performance and lifetime



ADVANTAGES

- Extended working tip in comparison to the standard chisel for an increased lifetime.
- Self-sharpening design for economical working and reducing downtime.
- Advanced 'jam protection' for reduced friction.
- Specially designed working tip increases the performance and ensures a high removal of material.

APPLICATIONS

Suitable for creating holes, slots and installation paths as well as break-throughs in:

- Concrete
- Masonry
- Natural stone

CHARACTERISTICS



TECHNICAL DATA

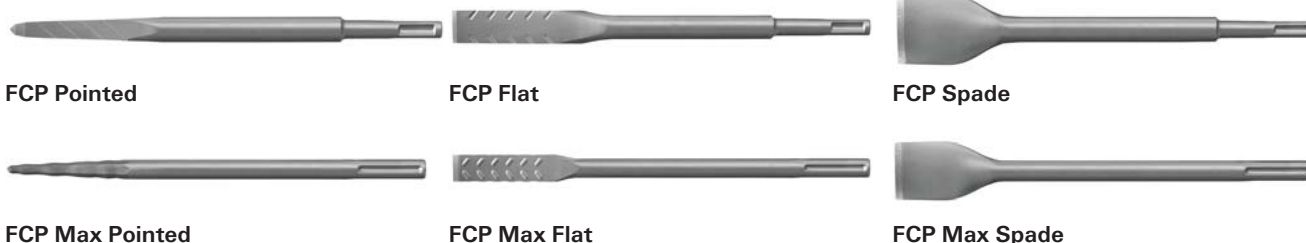

Item	Art.-No.	Type	Length	Width	Contents	Sales unit
			l [mm]	B [mm]		
FCP Pointed 250	546314	Pointed	250	—	1	1
FCP Flat 20/250	546315	Flat	250	20	1	1
FCP Spade 40/250	546316	Spade	250	40	1	1
FCP Max Pointed 400	546317	Pointed	400	—	1	1
FCP Max Flat 25/400	546318	Flat	400	25	1	1
FCP Max Spade 50/380	546319	Spade	380	50	1	1
FCP Set	546320	Pointed, Flat, Spade	—	—	3	1
FCP Max Set	546321	Pointed, Flat, Spade	—	—	3	1

High-performance Standard chisel with SDS Plus and SDS Max drill chuck



ADVANTAGES

- The SDS Plus and SDS Max drill chuck for the chisel allow for use with professional hammer drilling machines, and ensure a proven and safe transfer of force.
- The use of a high quality, specially hardened steel with surface protection increases the life span of the tools.
- The high oscillation endurance allows for high work comfort and contributes to the achievement of clean results.

APPLICATIONS

Suitable for creating holes, slots and installation paths in:

- Concrete
- Masonry
- Natural stone

CHARACTERISTICS



TECHNICAL DATA



SDS Plus and SDS Max Pointed



SDS Plus and SDS Max Flat



SDS Plus and SDS Max Spade



SDS Plus and SDS Max Hollow



SDS Plus and SDS Max Tile

Item	Art.-No.	Type	Length		Width		Contents [pcs]	Sales unit [pcs]
			I [mm]	B [mm]	B [mm]	B [mm]		
SDS Plus Pointed 250	504277	Pointed	250		12		1	1
SDS Max Pointed 280	504281	Pointed	280		16		1	1
SDS Max Pointed 400	504282	Pointed	400		20		1	1
SDS Max Pointed 600	504283	Pointed	600		27		1	1
SDS Plus Flat 20/250	504278	Flat	250		20		1	1
SDS Max Flat 25/280	504284	Flat	280		25		1	1
SDS Max Flat 25/400	504286	Flat	400		25		1	1
SDS Max Flat 25/600	504287	Flat	600		25		1	1
SDS Plus Scaling 40/250	504279	Spade	250		40		1	1
SDS Max Scaling 50/400	504288	Spade	400		50		1	1
SDS Max Scaling 80/300	504290	Spade	300		80		1	1
SDS Max Scaling 115/350	504291	Spade	350		115		1	1
SDS Plus Hollow 22/250	504280	Hollow	250		22		1	1
SDS Max Hollow 26/300	504293	Hollow	300		26		1	1
SDS Plus I M-Tile scaling 40/250	531437	Tile scaling	250		40		1	1
SDS Max Tile Scaling 50/400	504295	Tile scaling	400		50		1	1

The all-rounding bit within convincing quality



ADVANTAGES

- The bits manufactured from special steel with high hardness degree are suitable for both hand driven and machine guided applications.
- The perfect fitting inside screws ensures working with low-wear of the product and consequently long lifetime and clean working results.
- The profile guarantees an ideal connection for an optimal power and torque transmission that prevents damages of the surface or the screw-heads.
- Also available as clearly arranged bit-set with 11 or 31 pcs including bit-holder.

APPLICATIONS

Number of internal drives in various profile sizes, such as:

- PH, PZ cross-slot
- TX star recess
- Suitable for 1/4" drives

TECHNICAL DATA



Profi-bit **FPB T W**



Profi-bit **FPB PZ W**



FPB PH 2 DRYWALL W 1

Item	Art.-No.	Drive	Length l [mm]	Contents	Sales unit [pcs]
FPB T 30 90 mm PROFI Bit W 1	542369	TX30	90	1 Bit	1
FPB T 30 150 mm PROFI Bit W 1	542372	TX30	150	1 Bit	1
FPB T 40 90 mm PROFI Bit W 1	542370	TX40	90	1 Bit	1
FPB T 40 150 mm PROFI Bit W 1	542373	TX40	150	1 Bit	1
FPB T 50 PROFI Bit W 1	533085	TX50	25	1 Bit	10
FPB T 50 90 mm PROFI Bit W 1	542371	TX50	90	1 Bit	1
FPB PH 2 50MM PROFI Bit W 1	533105 1)	PH 2	50	1 Bit	10
FPB PH 2 DRYWALL W 1	533090	PH 2	25	1 Bit	10
FPB PZ 2 50MM PROFI Bit W 1	533109	PZ2	50	1 Bit	10
FPB PZ 4 PROFI Bit W 1	533099	PZ 4	32	1 Bit	10
FPB T 10 PROFI Bit W 10	533112	TX10	25	10 Bit	10
FPB T 15 PROFI Bit W 10	533113	TX15	25	10 Bit	10
FPB T 20 PROFI Bit W 10	533114	TX20	25	10 Bit	10
FPB T 25 PROFI Bit W 10	533115	TX25	25	10 Bit	10
FPB T 30 PROFI Bit W 10	533116	TX30	25	10 Bit	10
FPB T 40 PROFI Bit W 10	533117	TX40	25	10 Bit	10
FPB PH 1 PROFI Bit W 10	533118	PH1	25	10 Bit	10
FPB PH 2 PROFI Bit W 10	533119	PH 2	25	10 Bit	10
FPB PH 3 PROFI Bit W 10	533120	PH3	25	10 Bit	10
FPB PZ 1 PROFI Bit W 10	533121	PZ1	25	10 Bit	10
FPB PZ 2 PROFI Bit W 10	533122	PZ2	25	10 Bit	10
FPB PZ 3 PROFI Bit W 10	533123	PZ3	25	10 Bit	10

1) Delivery time on request.

The non-slip bit



ADVANTAGES

- The coating with diamond-sapphire-particles ensures the best possible power-transfer and prevents the bit tip from slipping out of the screw head.
- The diamond-coated bit with a high hardness grade guarantees the greatest service life and corrosion resistance.
- The torsion zones created by the tapered bit cross-section offers relief in the case of extreme loads. For a more effortless installation and maximum operating efficiency.
- The high dimensional accuracy allows for an ideal fit. For clean results and a long life span.

APPLICATIONS

Number of internal drives in various profile sizes, such as:

- PH, PZ cross-slot
- TX star recess
- Suitable for 1/4" drives

TECHNICAL DATA



Diamond-bit **FDB T W**

Item	Art.-No.	Drive	Length [mm]	Contents	Sales unit [pcs]
FDB T 10 DIAMANT Bit W 10	533136	TX10	25	10 Bit	10
FDB T 15 DIAMANT Bit W 10	533137	TX15	25	10 Bit	10
FDB T 20 DIAMANT Bit W 10	533138	TX20	25	10 Bit	10
FDB T 25 DIAMANT Bit W 10	533139	TX25	25	10 Bit	10
FDB T 30 DIAMANT Bit W 10	533140	TX30	25	10 Bit	10
FDB T 40 DIAMANT Bit W 10	533141	TX40	25	10 Bit	10
FDB PH 1 DIAMANT Bit W 10	533142	PH1	25	10 Bit	10
FDB PH 2 DIAMANT Bit W 10	533143	PH 2	25	10 Bit	10
FDB PH 3 DIAMANT Bit W 10	533144	PH3	25	10 Bit	10
FDB PZ 1 DIAMANT Bit W 10	533145	PZ1	25	10 Bit	10
FDB PZ 2 DIAMANT Bit W 10	533146	PZ2	25	10 Bit	10
FDB PZ 3 DIAMANT Bit W 10	533147	PZ3	25	10 Bit	10

The ultimate torsion-bit



ADVANTAGES

- The ultimate solution for extreme installation torques. Ideal for usage in high-performance power-and impact-tools.
- Optimal geometry of the profile guarantees unique performance and durability for sophisticated applications and users.
- The elastic torsion zone releases at extreme loads to ensure a gentle working and maximum operating efficiency.
- The high dimensional accuracy allows for an ideal fit. For clean results and a long life span.
- Also available as clearly arranged bit-set with 8pcs including bit-holder.

APPLICATIONS

Number of internal drives in various profile sizes, such as:

- TX star recess
- Suitable for 1/4" drives

TECHNICAL DATA



Maxx-bit FMB T

Item	Art.-No.	Drive	Length [mm]	Contents	Sales unit [pcs]
FMB T10 Maxx Bit W 5	533154	TX10	29	5 Bit	10
FMB T15 Maxx Bit W 5	533155	TX15	29	5 Bit	10
FMB T20 Maxx Bit W 5	533156	TX20	29	5 Bit	10
FMB T25 Maxx Bit W 5	533157	TX25	29	5 Bit	10
FMB T30 Maxx Bit W 5	533158	TX30	29	5 Bit	10
FMB T40 Maxx Bit W 5	533159	TX40	29	5 Bit	10

The bit holder for rapid bit exchange



ADVANTAGES

- The bit holder family for 1/4" bits with magnetic insert hold the bit securely in the drill chuck and offers a smooth installation procedure.
- Robust and slim bit holder for an easy bit exchange.
- Ideal for direct machine connection or enlargement of the bits to reach difficult areas.
- With the FBH Quick Bit Slim the Bit automatically locked when plugged in and provides a secure hold. By pulling back the sleeve the bit can be easily taken out.

APPLICATIONS

- The bit holders for use in cylinder drill chucks

TECHNICAL DATA



Bit holder **FBH W 1**



Bit holder **FBH Quick Bit Slim W 1**

Item	Art.-No.	Drive	Length	Contents	Sales unit
			[mm]	[pcs]	[pcs]
FBH Bit Holder W 1	533148	1/4"	50	1	1
FBH Quick Bit Slim W 1	533150	1/4"	50	1	1

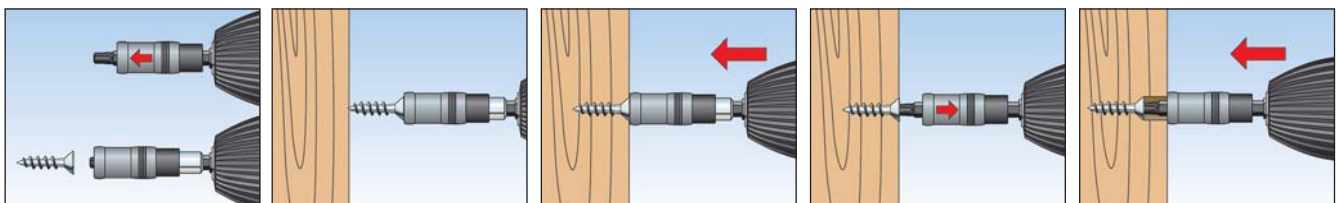

Useful bit sets for a multitude of applications



ADVANTAGES

- Safe and clearly arranged keeping of the content assuring a reliable usage day by day.
- The robust and durable construction fulfilling even hardest requirements.
- The bit sets combining compact dimensions with easy handling and containing the most common bits as well as the bit holder.

APPLICATIONS

- The ideal bit sets for quick and efficient working.
- For a high variation of applications

TECHNICAL DATA



Bit Set **FPB Profi W 31** with belt clip



Bit Set **FPB Profi W 11**

Item	Art.-No.	Contents	Sales unit [pcs]
FPB Bit Set Profi W 31	533152	2x PZ1, 4x PZ2, 2x PZ 3, 2x PH1, 4x PH2, 2x PH 3, 1x TX8, 2x TX10, 1x TX15, 2x TX20, 2x TX25, 1x TX27, 1x TX30, 1x TX40, each 1x Slot 4,5; 5,5; 6,0, 1x Universal bit holder	1
FPB Bit Set Profi W 11	533153	each 1x PZ1, PZ3, 2x PZ2, each 1x TX10, TX15, TX20, TX25, TX30, TX40, 1x Universal bit holder	1

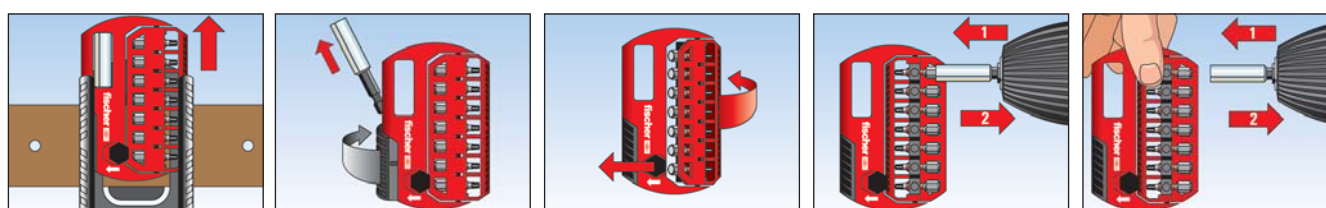

Ideal for use in high-performance power- and impact-tools



ADVANTAGES

- Optimal geometry of the profile guarantees unique performance and durability for complex applications and users.
- The high dimensional accuracy allows for an ideal fit. For clean results and a long life span.

APPLICATIONS

- The ultimate solution for extreme installation torques

TECHNICAL DATA



Nut SW



Nut TX



Profi-bit **FPB T50 5/16"**

Item	Art.-No.	Connection / drive	Total length		Sales unit
			[mm]		[pcs]
Nut SW10	538577	1/2" / SW10	78		1
Nut SW13	538578	1/2" / SW13	38		1
Nut SW15	538579	1/2" / SW15	38		1
Nut SW17	538580	1/2" / SW17	38		1
Nut SW21	538581	1/2" / SW21	38		1
Nut TX40	538575 ¹⁾	1/2" / 1/4"	35		1
Nut TX50	538576 ²⁾	1/2" / 5/16"	35		1
FPB Profi-Bit T50 5/16"	538574	5/16" / TX50	35		1

1) Suitable for FMB T40 Maxx Bit

2) Suitable for FPB Profi-Bit T50 5/16"

Building Material – Concrete

The substrate's quality is crucial when selecting the correct fixing:

A differentiation is made between concrete, masonry and panel building materials. Concrete is made from a mixture of cement, aggregates and water.

Concrete's main properties are:

- High level of compressive strength, but only low tensile strength ($\approx 10\%$ of the compressive strength).
- Inserting individual rebars and or mats will increase tensile strength (steel + concrete = reinforced concrete).
- Structure easily reproducible as it is regulated by standards, therefore it is an ideal anchor base.



Concrete is mainly split into two categories:

Standard concrete and lightweight concrete. While standard concrete contains gravel; lightweight concrete contains additives such as pumice, expanded clay or polystyrene® usually with a lower compressive strength or bulk density. This leads to unfavourable conditions for anchor fixings.

The load bearing capacity of heavy duty fixings depends on the concrete's compressive and tensile strength. This is indicated by the numbers in the abbreviations: e.g. the most commonly used concrete compressive strength is C20/25 with a cube compressive strength of 25 N/mm².

EXPERT TIP

- **Standard concrete qualities:**
C12/15 to C50/60, even higher grades are also available for special applications. The majority of anchors approved for concrete may only be used from concrete quality from C20/25 up to a max. of C50/60. In the past, designations from DIN 1045 were used in Germany: B25 (\approx C20/25) to B55 (\approx C45/55).
- **C20/25 means:**
 - C = concrete
 - 20 = compressive strength f_{ck} or $f_{ck, c_{yl}}$ of a concrete test cylinder (\varnothing 150 mm, height 300 mm) in N/mm²
 - 25 = compressive strength f_{ck} , cube of a concrete test cube (edge length 150 mm) in N/mm²
- **Normal concrete** without accelerating additives reaches its nominal strength after 28 days. Only then can the fixing be installed in compliance with the approval/assessment.
- **Fresh concrete:** still workable up to approx. one hour after pouring.
- **Green concrete:** starts to harden after four hours, no longer workable.
- **New concrete:** is hardened after 28 days, however minimum compressive strength not yet reached.
- **Hard concrete:** more than 28 days old, nominal strength reached.

Compressive strength classes in different countries

Country	Specimen	Dimensions ¹⁾ [cm]	Concrete strength class	Unit	Standard
China	Cube	15x15x15	C15, C20, C25, C30, C35, C40, C45, C50, C55, C60	N/mm ²	GB50010-2010
Denmark	Cube	15x15x15	C12/15, C16/20, C20/25, C25/30, C30/37, C40/50, C45/55, C50/60	N/mm ²	DS/EN 206
Germany	Cube	15x15x15	C12/15, C16/20, C20/25, C25/30, C30/37, C40/50, C45/55, C50/60	N/mm ²	EN 206
France	Cylinder	16x32	B20, B25, B30, B35, B40, B45, B50	N/mm ²	BAEL 91
Great Britain	Cube	15x15x15	C20, C25, C30, C37, C40, C45, C55, C60	N/mm ²	BS EN 12390-3:2009
Italy	Cube	15x15x15	C 8/10, C12/15, C16/20, C20/25, C25/30, C28/35, C30/37, C32/40, C35/45, C40/50, C45/55, C50/60	N/mm ²	UNI EN 206
Japan	Cylinder	10x20	≥ 15	N/mm ²	JIS A 1108
Korea	Cylinder	10x20, 15x30	18, 21, 24, 27, 30	N/mm ²	KS F 2405
The Netherlands	Cylinder	15x30	C 8/10, C12/15, C16/20, C20/25, C25/30, C30/37, C35/45, C40/50, C45/55, C50/60	N/mm ²	NEN-EN 206-1
Austria	Cube	15x15x15	C 8/10, C12/15, C16/20, C20/25, C25/30, C30/37, C35/45, C40/50, C45/55, C50/60	N/mm ²	ÖNORM B 4710-1
Sweden	Cube	15x15x15	C12/15, C16/20, C20/25, C25/30, C30/37, C40/50, C45/55, C50/60	N/mm ²	SS-EN206
Switzerland	Cube	15x15x15	C12/15, C16/20, C20/25, C25/30, C30/37, C40/50, C45/55, C50/60	N/mm ²	SIA 262
Spain	Cylinder	15x30	Unreinforced concrete: HM-20, HM-25, HM-30, HM-35, HM-40, HM-45, HM-50 Reinforced concrete: HA-25, HA-30, HA-35, HA-40, HA-45, HA-50 Pre-stressed concrete: HP-25, HP-30, HP-35, HP-40, HP-45, HP-50	N/mm ²	EHE-08
USA	Cylinder	15x30	2000, 2500, 3000, 3500, 4000, 5000, 6000, 7000, 8000	Psi	ACI 318

¹⁾ Conversion: $f_{\text{Cylinder}} = 0.85 \times f_{\text{Cube, 20x20x20}} = 1.05 \times f_{\text{Cube, 15x15x15}}$

EXPERT TIP

- **Anchors** used in **new concrete** must be **suitable** for this purpose, or may only bear loads after reaching the minimum compressive strength.
- **Concrete** always shows **cracks** (shrinkage during hardening, loading).
- In **cracked concrete**, anchors which are tested in cracked concrete must be used. These **anchors** must be able to **expand** when concrete starts to crack e. g. expansion anchors (e. g. FAZ II), form locking anchors or undercut anchors (e. g. FZA), or bonded anchors (e. g. FIS SB).
- **Cutting through reinforcement steel** while making **drill holes** is **not permitted**. In special cases, non load-bearing steels can be cut after consultation with the responsible engineer.
- The load bearing capacity of the concrete along the entire drill hole must be guaranteed (no honeycombing in the concrete, no voids and pockets).
- **Pre-stressed concrete**: A certain drilling distance must be maintained from the tensioning strands as stated in the approval/assessment (e. g. FHY, FBS 6 or EA II).

NOTE

Building Material – Masonry

Compared to concrete, there is a larger variety of masonry building materials.

Masonry can be classified according to:

- brick type used (e. g. natural stone, lime stone or aerated concrete).
- wall type (e. g. single or double layer).
- brick strength class and gross density.

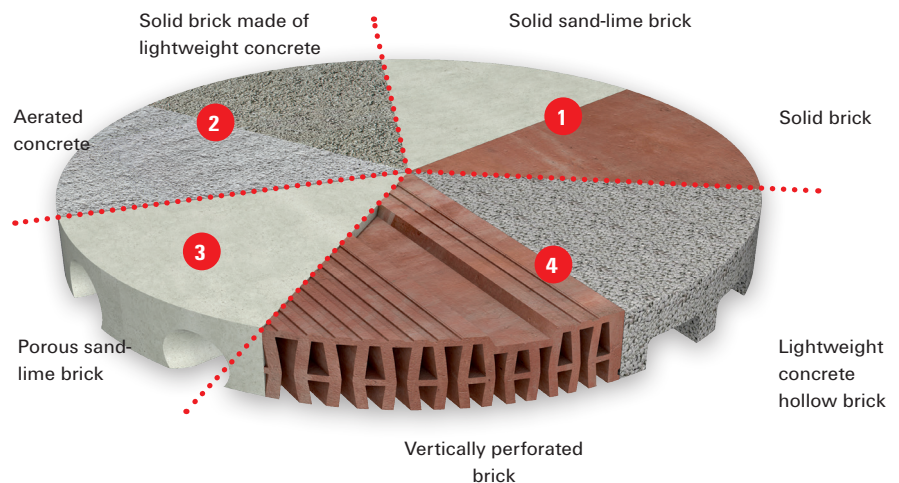

Generally, masonry is classified into four groups:

- 1 Solid bricks with a dense structure** are a highly compression resistant building material, without cavities or low hole surface percentage (up to a max. 15 % e. g. as grip holes). This type is very well suited for anchor fixings.
- 2 Solid bricks with porous structure** usually have a very large number of pores and low compressive strength. Therefore, special fixings should be used, e. g. fixings with a longer expansion zone or bonded anchors.
- 3 Perforated bricks with a compact structure** (perforated and hollow bricks) are mostly manufactured from the same compressive strength materials as solid blocks but with cavities. If higher loads are introduced into these building materials, special fixings should be used (e. g. bonded anchors, FIS V), which bridge or fill the cavities.
- 4 Perforated bricks with porous structure** have many cavities and pores and thus generally a low compressive strength. In this case, special care is required when selecting the fixing. Suitable fixings include those with a long expansion zone or form locking injection anchors.

EXPERT TIP

- Before **fixing in masonry**, determine which brick type (designation, size, compressive strength) and mortar type (mortar category) has been used.
- For **safety anchoring** in unknown or old masonry, pull out tests must be carried out on-site to determine the anchor load bearing capacity.
- For **fixings close to the edge**, it is important to know if the wall is a load bearing wall as this prevents the risk of brick pull out.
- Even **solid brick** can have holes (e. g. MZ, KS). The holes are mostly larger grip-holes in the centre of the brick (up to max. 15 % cavity proportion per brick).
- Always drill without hammer function in **perforated and hollow bricks**. Here, special, sharply ground drills with hard metal tips are suitable.
- **Plaster or other non load-bearing layers** may not be added to the load-bearing base and are not to be used in calculating the anchorage depth.
- **Avoid anchoring into masonry joints** as much as possible due to joint inhomogeneity. If anchoring into a joint cannot be avoided (e. g. plaster on masonry) loads should be reduced.
- For **systems approved by building authorities, anchoring in joints** (vertical or horizontal joints) is regulated in the approval notices.
- For **anchoring high loads** in perforated bricks, the anchorage depth should be increased.
- **Expansion fixings** (e. g. FAZ II or FBN II) are not suitable for use in masonry due to its high expansion forces which may lead to cracks in the brick. Frame fixings are suitable due to its longer expansion part.
- **Bonded anchors** achieve the highest possible loads in masonry.

Building Material – Drywall Panels

Panel building materials are thin-walled materials that often have limited strength – e. g. plasterboard like “Rigips”, “Knauf”, “LaGyp”, “Norgips”; Gypsum fibreboard like “Fermacell”, “Rigicell” or chip board, hard fibre boards, plywood and others.

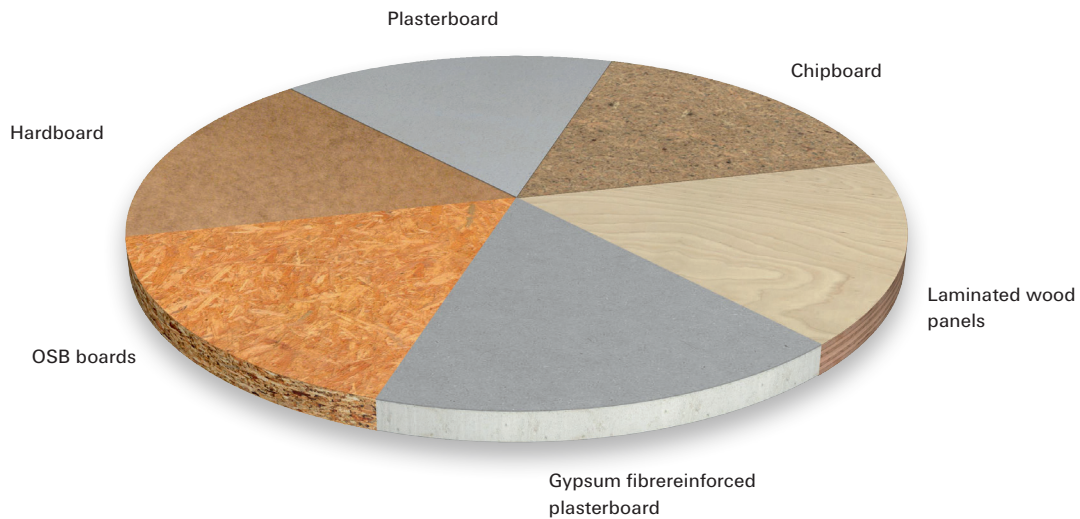

The main characteristics of panel building materials are:

- Often thin-walled materials, mainly with limited strength.
- Easy-to-process materials for non load-bearing walls and also used as cladding material (e. g. walls, roofs or ceilings).
- A wide range of different building materials.

Special fixing elements must be used:

Cavity fixings are fixings made of plastic or metal, which anchor by form locking into the material, e. g. by knotting or a snap on mechanism (e. g. toggles).

EXPERT TIP

- Only approved anchors should be used for **lightweight materials, prestressed hollow core slabs and panel materials**.
- Contact your **fischer consultant** on site before anchoring **heavy or safety-relevant loads** in the above-mentioned substrates.

NOTE

.....

.....

.....

.....

.....

.....

.....

.....

.....

.....

Drilling

The building material determines the drilling method.

Five methods are possible:

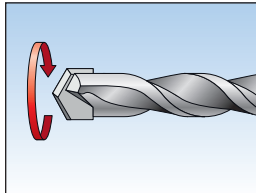

Rotary drilling

Rotary drilling without impact, uses a sharply ground carbide drill bit. When this method is used, the drill hole does not become too large and the perforated brick's webs do not break.

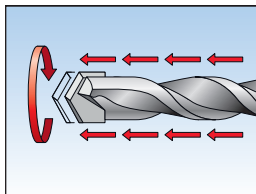
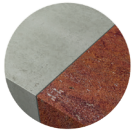

Impact drilling (mechanical)

Impact drill with rotation and a high number of light strokes, is suitable for dense structured building materials.

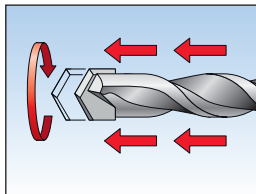
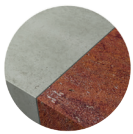

Hammer drilling (pneumatic)

Hammer drill uses rotation and a low number of light strokes with high impact energy, also suitable for dense structured solid building materials.

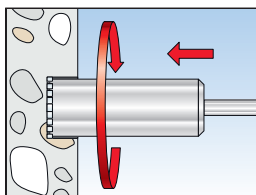

Diamond or core drilling process

Mainly used for larger drill hole diameters or for heavily reinforced components and/or if noise or vibration must be reduced.

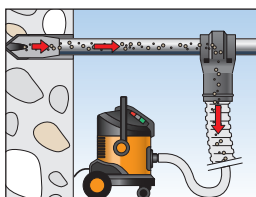
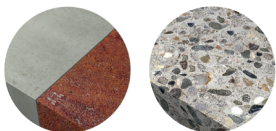

Hollow drilling

Special drill with a hollow core, which is connected to a vacuum cleaner. Cleans the drilled hole during the drilling operation. No further brushing or blowing is required. Can be used in concrete and masonry with dense structure.

EXPERT TIP

- The drilling method for approved anchors is specified in the **approval/assessment**.
- Drill bits with **excessively worn cutting** edges should **not be used** (see approval/assessment).
- For certain fixings, **special drills** are required (e.g. a stop drill) as per approval/assessment.
- **Drill holes** must be **carefully cleaned** (blown out and brushed). See the respective approval/assessment or manufacturer's specifications.
- The **drill hole depth** is always exactly specified and relates to a given anchoring base thickness. For general applications without an approval/assessment the following applies: the drill hole depth + 30 mm should not exceed the anchoring base thickness.
- In case of **incorrect drilled** holes (hitting reinforcements or wrong location), the location for the new drill hole is regulated in the applicable fixing approval/assessment). Usually, the distance for the new drill hole must be twice the depth of the incorrect drill hole. The wrong drill hole must be filled with injection mortar (e.g. FIS V).
- **Diamond core drilling** is only permitted if stated in the approval/assessment or according to manufacturer's guidelines (e.g. RSB, FIS EM, FAZ II, FBS II...).
- **The load bearing capacity is reduced** by water filled holes or wet substrates especially for chemical or plastic fixings.
- **Cutting** through a reinforcement is not permitted.
- **The drill hole** must be drilled perpendicular to the anchor base (an inclination of up to 5° is permitted). Exceptional cases are regulated in the anchor approval/assessment and or according to manufacturer's guidelines.

Installation types

There are three different types of installation.

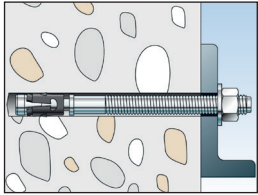

Anchor bolt FAZ II

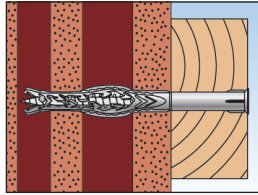

Frame fixing SXRL

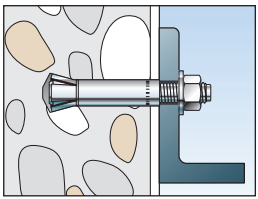

Zykon anchor FZA

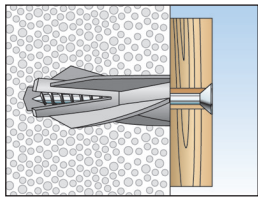

Aircrete anchor GB

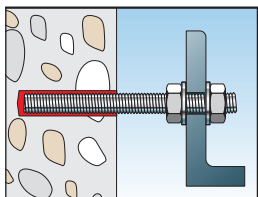

Threaded rod FIS A

Push-through installation

In particular for simplifying installation for series installations or for attachments with two or more fixing points:

- If the attachment's hole diameter is larger than the drill bit diameter, then the attachment can be used as a template. Please note: The drill bit tip is generally larger than the nominal diameter of the drill.
- In addition to facilitating a simple installation, an exact fit is also achieved.
- The fixing is inserted into the drill hole through the attachment and then tightened (e.g. FAZ II, FBN II, FH II).

Pre-positioned installation

The anchor is installed before fastening the attachment. If drilling is not done precisely, then the holes in the attachment will not match up. This could mean that the anchors cannot be installed or could cause damage to the anchors. The installation sequence:

- Transfer the hole pattern of the fixture to the anchor base.
- Drill and clean the holes, install the attachment and then fix the attachment (e.g. plastic fixings: S, SX, UX; metal fixings: FZA, EA II).

Stand-off installation

This allows attachments to be compression and tension resistant at a certain distance from the anchor base. For this purpose, external threaded metal anchors (e.g. FAZ II, FBN II) or internal threaded anchors (e.g. EA II) with screws or threaded rods are clamped against the anchor base surface while using a bearing washer and nut. When using chemical systems with threaded rods (e.g. FIS SB, FIS V, FIS EM, and FIS A), the installation can be done without using a bearing washer and nut.

EXPERT TIP

- **Clearance holes in the attachment** are specified for the respective anchor size in the approvals/assessments and manufacturer's guidelines.
- For **stand-off** installations with shear loads on the anchor, additional bending moment occurs and this must be considered.
- **The attachment must lie** fully flush on the surface base or it must have either a compression resistant levelling layer of max. 3 mm or half the anchor's diameter, otherwise the anchor must be checked for bending.
- **The attachment shall be in contact with the anchor** over its entire thickness, otherwise the anchor must be checked for bending.
- **Usable length is the maximum fixing height** t_{fix} which takes into account the attachment's thickness plus additional non-bearing layers (e.g. plaster, air, insulation etc.).
- Post-installed anchors must be tightened with a specific torque. A calibrated torque wrench must be used to ensure the correct pre-stressing force and the correct installation of the anchor. For **chemical anchors, the prescribed hardening time must be adhered to** before tightening torque or service load can be applied.
- Anchors must be mounted as a standard unit as delivered. The exchange or removal of parts is not permitted.

Loads

When selecting an anchor, it is necessary to know the load on the total construction and the resulting action forces.

Action forces can differ based on:

Dimension ▪ Direction ▪ Type of load ▪ Point of application

There are various types of loads:

Approvals generally give characteristic resistance. In the manufacturer's guidelines, "permissible loads" are specified for products with approvals. For anchors without an approval, "recommended loads" are given by the manufacturer.

- **Determine the size,** direction and point of application of the load. These parameters determine which anchor should be used.
- **Characteristic resistance** (N_{RK} or V_{RK}) describes the 5% fractile of resistance. (Value with a 95% probability of being exceeded, with a confidence level of 90%).
- **Permissible loads** are working loads that already include an appropriate safety factor. These only apply if the approval conditions are complied with (N_{zul} or V_{zul}).
- **Recommended loads or maximum working loads** include an adequate safety factor. These only apply if the manufacturer's specifications are complied with (F_{rec} – valid for all load directions, N_{rec} – for compressive or tensile load or V_{rec} for shear load).
- **The calculation** is carried out by dividing the respective failure load or characteristic loads by a safety factor.
- **Recommended safety factors compared to the average failure load:**

Steel and bonded anchors	$\gamma \geq 4$
Plastic anchors	$\gamma \geq 7$
Hammerfix anchors N	$\gamma \geq 4$
- **Recommended safety factors compared to the characteristic failure loads:**

Steel and bonded anchors	$\gamma \geq 3$
Plastic anchors	$\gamma \geq 5$

For deviations to the regulation, see load tables. For certain products, the safety factors may deviate. In general, the global safety factor is calculated using the scatter of the failure load, the failure probability and the reliability index of a product.
- **The specified loads** apply to individual anchors that are installed away from the edge, i.e. there is no influence from edges or other anchors.
- **The characteristic spacing and edge distances,** marked with c_{crN} and c_{crV} , give the distances at which an anchor achieves its max. characteristic load.

Load directions

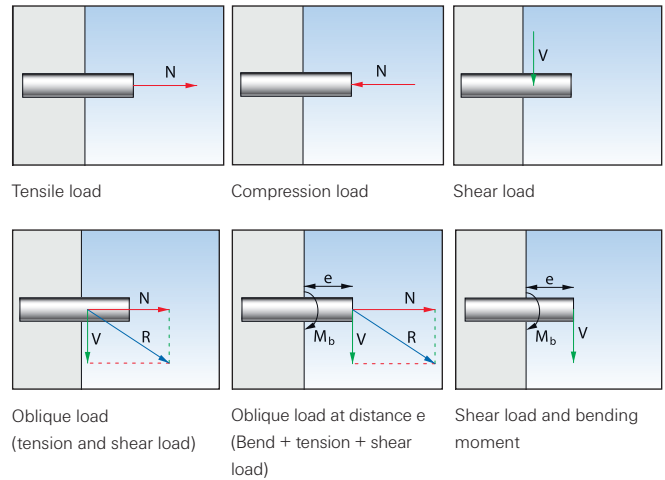

Types of loads

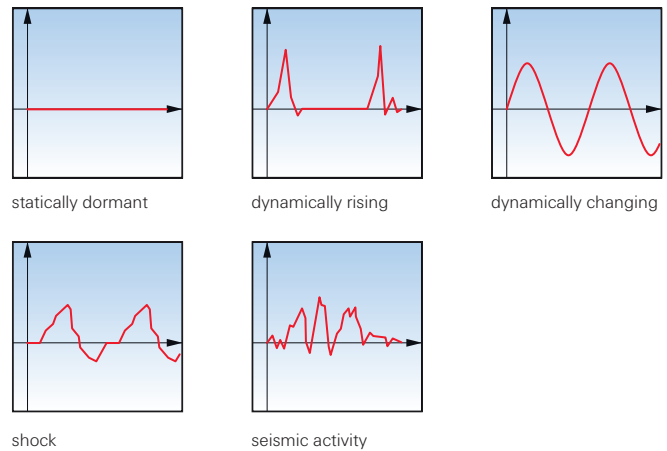

- **The specified minimum spacing and edge distance,** marked with s_{min} and c_{min} , indicates the distance at which no failure of the building material will occur when installing the anchor (cracks). These distances are mandatory and must be complied with. The characteristic spacing and edge distances may be shorter but not less than the minimum values but at the same time the load bearing capacity must be reduced. When combined loads occur, loads are determined separately for tensile and shear load and the overall utilization is determined by means of an interaction equation. As a rule, the sum of the ratio values from tensile and shear loads is less than 1.2.

Cracks in concrete components

Cracks can occur anywhere in concrete at any time: Factors involved in this are loads such as dead loads, traffic or wind loads, concrete shrinkage and creeping or external influences such as seismic activity or ground motion result in stresses and deformations thus leading to cracks.

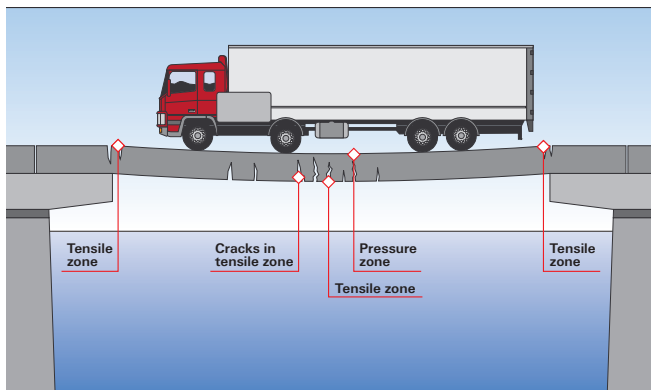

Example:

If a bridge designed as a single-span element is loaded, the bridge will buckle. Due to this buckling, cracks could occur in the element's tensile area.

Concrete is not able to support tensile loads, therefore, reinforcements are placed in the element to take the tensile load area numerous cracks are formed that are barely visible to the naked eye. This is called the cracked tensile zone.

15

Suitable anchor systems for cracked concrete

When fixing in concrete, **cracks** are always **expected in the anchoring area which will have an impact on the load bearing capacity** of the anchor system. However, it is very complicated, if not impossible, to prove whether the concrete is cracked or not cracked.

For safety reasons, designers and craftsmen should **always use anchor bolts which are suitable for cracked concrete.** Fixings with an approval/assessment according to ETAG 001 for cracked concrete have proven their suitability in cracks, therefore they can be used without any restrictions in tensile and compression zones of a concrete member.

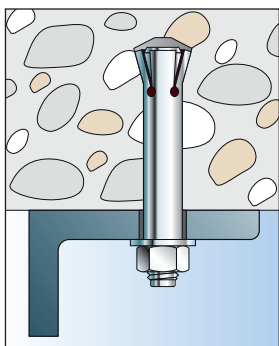

Undercut anchor FZA

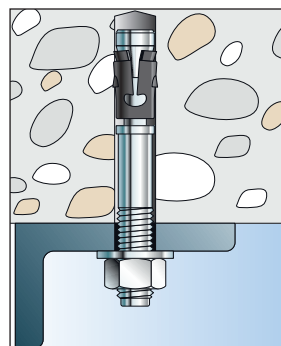

Bolt anchor FAZ II

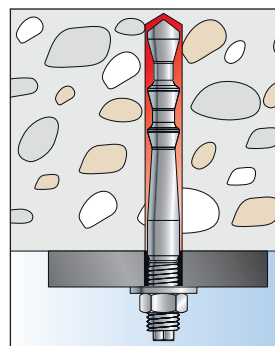

Threaded rod FHB II

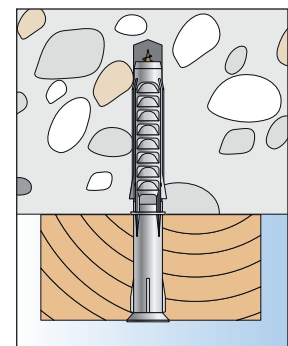

Frame fixing SXS

Due to safety reasons, always use crack-suitable anchor systems such as FAZ II, FH II, FHB II, FIS SB, FIS EM or FIS V.

Basic Knowledge

Fire protection – Fundamentals

General requirements of building structures
for fire protection.

Structural installations

Structural installations are to be ordered, erected, changed and brought into commission in such a way that:

- the emergence of a fire is prevented from breaking out.
- the spread of fire and smoke (spread of fire) is prevented.
- in the event of a fire, the rescue of people and animals is possible.
- effective fire-fighting operations are possible.

German regulation

In Germany, the procedure for construction and operational fire protection are specified by the fire protection standard DIN 4102, the Model Building Ordinance (MBO), Regional Construction Ordinances (LBO) and various trade-specific regulations from professional associations.

The following applies as per Section 1 and 2 of DIN 4102:

Building materials such as **concrete, wood, stone, metal** etc., are classified according to their behaviour **into flammable or non-flammable building material classes.**

However, **components composed** of different **flammable and non-flammable materials** are not classified into fire classes in building construction but they are evaluated as a complete system according to their fire resistance duration. The fire resistance duration R is indicated in minutes and classified according to two categories:

- **Components with a fire resistance duration** of R30 and R60 are fire-inhibiting.
- **Fire-resistant**, are all components with a fire resistance duration of R90, R120 and R180.

Tested systems such as cable, ventilation or duct systems are not only tested for fire resistance, but also for functional capability in the event of fire (e.g. supply lines to sprinkler systems). The fire resistance duration of these systems is e.g. E30 to E120 for electrical cable systems or L30 to L120 for specified ventilation ducts. The anchors that are used to fasten these systems must have at least the same fire resistance duration.

European standardisation

In accordance with the European Norm DIN EN 13501-1, the classification of fire behaviour of building materials / products is similar to that of DIN 4102. The classifications are, however, much more precise.

In addition to, the main classification criteria concerning flammability, flame spread and heat released, e.g. smoke development and dropping behaviour is tested.

Fire resistance of components has been tested in Germany in accordance with the European Norm DIN EN 1363 or DIN EN 1365 since 2000. The fire resistance duration is then labelled with the letter R for "Resistance".

The standard temperature-time curve (ETK) of DIN 4102 and ISO 834 is based on a simulation of real fire conditions and forms the evaluation basis that is used worldwide to determine the fire resistance duration. In addition, there are other temperature curves for special fire exposures, e.g. the hydrocarbon curve for destructive fires caused by flammable liquids or the RAB/ZTV tunnel curve (Germany) or the Rijkswaterstaat tunnel curve (the Netherlands), which describe tunnel fires.

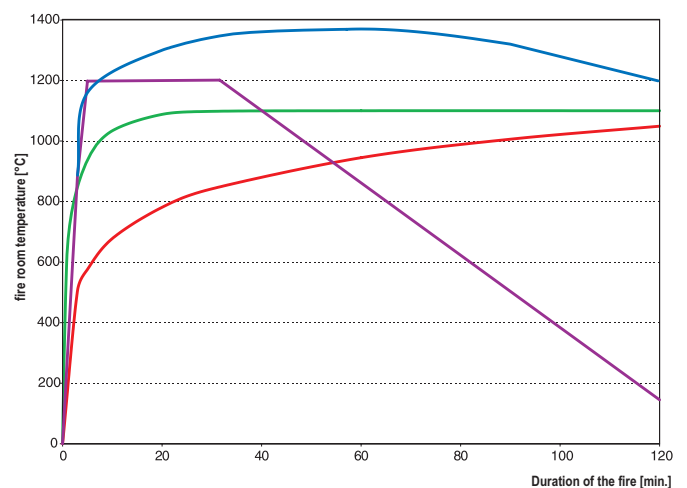

Temperature curves: — (ETC), — Hydrocarbon curve, — RABT/ZTV tunnel curve — Rijkswaterstaat tunnel curve

Fire protection in fastening technology

The fastening technology has a vital importance in fire protection.

To ensure the functional capability and stability of railings, pipe systems, fire safety doors or ceiling elements.

Assessing fixings for fire is carried out in accordance with the technical regulation EOTA TR020 or in accordance with fire protection reports.

The labelling and classification of anchors and fixings is classified in:

- 1 Fire behaviour (e.g. non-flammable)
- 2 Fire resistance duration (e.g. R90)

For this purpose, the legal regulations set down in the final draft of the Delegated Act "Fire Behaviour" must be observed.

EOTA TR020 only states anchor performance ratings that have an **ETA for cracked concrete!** Meanwhile, a new evaluation document issued by the German Institute for Construction Engineering (DIBt) is used to determine the characteristic load values and the corresponding fire resistance duration.

A partial safety factor of $\gamma_M = 1.0$ on the load side is used in the event of fire.

The fire values only refer to anchor bolts that are directly exposed to flames.

Alternatively, anchors can be protected from direct exposure to fire by using fire protection panels or fire protecting coatings.

For fixing cladding systems, it is assumed that the load bearing capacity of specified plastic screw anchors in concrete with an external diameter of 10 mm and a metal screw diameter of 7 mm and an anchoring depth of $h_{ef} = 50$ mm with a polyamide PA6 plastic sleeve has a sufficient fire resistance of at least 90 minutes (R90), if the permissible load (no permanent centric tensile load) is ≤ 0.8 kN.



Before the fire test

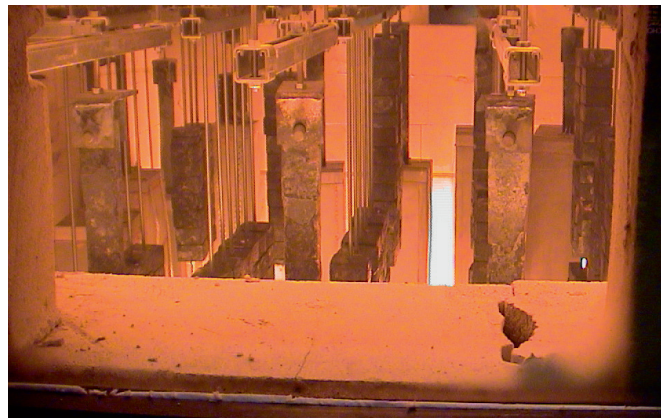

During the fire test



After the fire test

Corrosion – Fundamentals

Corrosion is a chemical reaction which degrades metal.

The less noble the metal ("electrochemical potential"), the more severe the material damage is, resulting in metal loss or corrosion flakes. For this reason, different appearance patterns have been determined. **The most common types of corrosion in fixings and anchors are:**

Surface corrosion: In this case, the metal corrodes relatively uniformly over the entire surface or over a part of the surface. An example of this is the invisible rusting of a screw in the transition area from anchor plate to hole due to condensation. The result: A connection that appears completely intact from the outside, but suddenly fails.

Contact corrosion: If metals with a different nobility are in contact with each other in a conductive medium, the less noble metal always corrodes (the anode). Whereas stainless is not affected. A decisive factor is the surface ratios of the two types of metal: The greater the surface area of the most noble metal in comparison with the less noble, the greater the corrosion. For example, if larger stainless steel sheets are screwed with galvanised screws, the screws will be aggressively attacked within a very short time. Whereas using stainless screws in galvanised sheets poses no problems.

Stress corrosion cracking: Permanent internal or external tensile stresses lead to metal strain or corrosion. In this process, a crack develops due to mechanical stresses, which grows under increasing loads and thus creates a path for progressive corrosion. For example, this occurs with stainless steel of corrosion resistance Class III e.g. A4, in an atmosphere containing chlorine (swimming pools). Generally, stress corrosion cracking is not visible with fixings and usually leads to sudden failure of the anchoring.



In 1985, the suspended concrete ceiling of an indoor swimming pool collapsed in Uster, Switzerland. The stainless steel ceiling attachments exhibited no external defects, but were completely destroyed internally in some cases due to stress corrosion cracking.

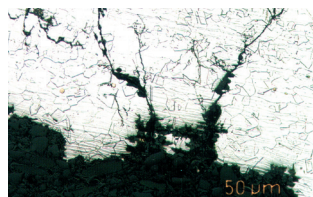

Example of trans-crystalline stress corrosion cracking on stainless steel 1.4401 with high chloride concentration

Corrosion protection

There are different ways to protect fastenings from corrosion. The most important are:

Galvanised zinc coating (or also electrolytic zinc coating) followed by passivation is the most common corrosion protection used in metal finishing. A zinc coating thickness of 3 – 10 µm offers excellent corrosion protection for damp rooms and outdoor use.

Hot-dip galvanising is the application of a metal zinc coating by dipping it in molten zinc (at approx. 450 °C). Zinc layer thickness's of 45 – 80 µm offer an excellent corrosion protection for moist rooms and outdoor use.

Stainless steel fixings of corrosion resistance class III e.g. A4, material no. 1.4401, 1.4404 and 1.4571 as well as two phased duplex steel (austenitic and ferritic structure/ magnetic) are suitable for anchoring in damp rooms, in open air, in industrial atmospheres or near the sea (but not directly in sea water).

Stainless steel anchors made from high corrosion-resistant steel of the corrosion resistance class V e.g. material no. 1.4529 are used in especially aggressive environments e.g. in atmospheres containing chlorine (swimming pools), in road tunnels or with direct sea water contact. Due to their high molybdenum content they are resistant to such aggressive environments. That means that steel type 1.4529 – containing chrome, molybdenum and nickel – has an alloy content of 58%. The rest consists of iron and carbon. Due to this very high alloy content, the production for this steel type is very expensive, but on the other hand the connection is safe and maintenance – free in terms of corrosion.

Dynamics

For predominantly non-static loads.

The general building approvals issued by the **German Institute of Construction Engineering (DiBt)** and the **European Technical Approvals / Assessments (ETA)** are mainly valid for predominately static loads. However, there are certain applications e.g. swinging cranes, crane rails, jib cranes, elevator guide rails, machines, industrial robots and blast fans in tunnels including antenna and masts which are subjected to dynamic effects.

In general, the anchoring of components with more than > 1000 load cycles must be carried out using fastening elements that have been checked and approved for this purpose. Until recently, the design for post-installed anchors for such dynamically loaded applications was nearly impossible. Time consuming and costly expert reports and or approvals for individual applications were required.

The bonded anchors: fischer Highbond anchor FHB dyn and fischer UMV multicone dyn and FDA have a German DiBt approval for dynamic loads. In the approval, only fatigue loads are considered as dynamic loads and not loads from shock or seismic activity.



Elevator guide rails

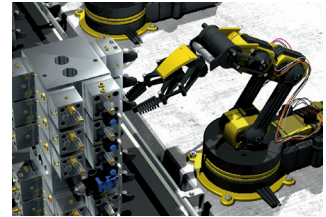

Industrial robots

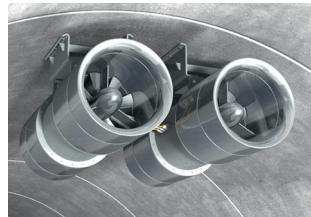

Blast fans



Antenna and masts

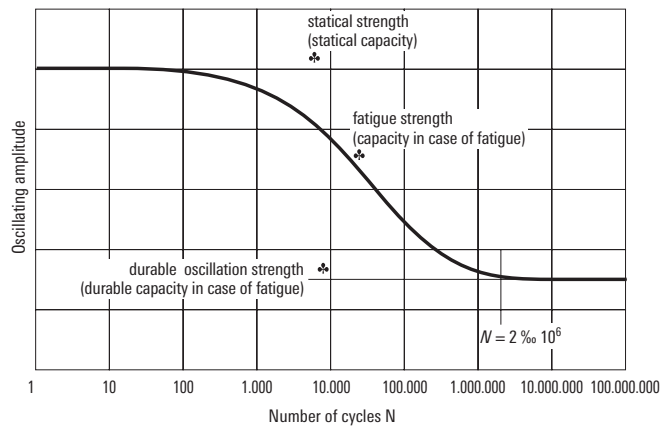

Wöhler curve

The approvals apply to the anchoring of dynamic loads with unlimited numbers of load cycles, for tension and for shear loads.

In addition, the FHB dyn is manufactured in anchor size M12 and M16 from highly corrosion-resistant steel (e.g. corrosion resistant Class V - 1.4529).

Dynamic load tests have shown - compared to normal stainless steel grades of corrosion resistant class III (e.g. 1.4401 also known as 316) - that this material is not only highly suitable for indoor and outdoor humid environments, as well as other aggressive conditions, it is also highly suitable for dynamic loadings.

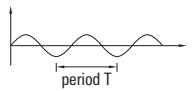
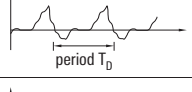
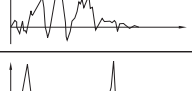
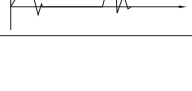
Action	Run of the oscillation	Possible cause
harmonic	 sinusoidal	Unbalances, tumbling machines
periodic	 optional, periodical	Regularly abutting parts (e.g. punching machines), rail- and road traffic
transient	 optional, nonperiodical	Earthquakes
impulsive	 optional, with very short time of influence	Impact, explosion

Legal basis

The European Union (EU) determines the legal foundation for the assessment, CE labelling and bringing building products into the European Economic Area (EEA).

The aim is to reduce trade barriers by harmonising the requirements of building products.

REGULATION (EU) No 305/2011 (Construction Products Regulations) OF THE EUROPEAN PARLIAMENT AND COUNCIL fully came into force on 1st July 2013. The Construction Products Regulation is law in all EU countries. However, the Construction Product Directive 89/106 / EEC is not law in all EU countries.

Construction products are products, or parts which are permanently incorporated into buildings. Their performance influences the structure's basic requirements (e.g. mechanical strength). Therefore, construction products and materials for safety relevant applications are affected.

Important building requirements include:

- 1 Mechanical strength and stability
- 2 Fire protection
- 3 Hygiene, health and environmental protection
- 4 Safety and accessibility during use
- 5 Sound protection
- 6 Energy saving and heat protection
- 7 Sustainable use of natural resources

When a construction product is covered by a harmonised standard (hEN), or a European Technical Assessment or Approval (ETA) has been issued for this product, the manufacturer is obligated to draw up a Declaration of Performance (DoP) for this product and affix the CE marking on the product. The application for an ETA for a construction product by the manufacturer is voluntary. National approvals may only be issued if a construction product is not marked with a CE label.

Existing European Technical Approvals (ETA) are valid until the end of the validity date and will be amended with the Declaration of Performance (DoP) by the manufacturer from the due date. The reference number of the DoP is part of the CE marking and must be determined by the manufacturer. The Declarations of Performance (DoP) are available on the fischer website under "Approvals/Assessments": <http://www.fischer.de/sdb>.

The CE mark is the only means to certify whether the manufacturer has conformed to the applicable harmonised requirements of construction products. The CE label allows the construction product to be freely traded without trade barriers in the European Economic Area.

Each Member State determines the essential characteristics for use of the construction product and its performance in its territory. The unrestricted use of a construction product in a Member State depends on whether performance values exist in the DoP for the essential characteristics determined by the Member State. If one characteristic is declared with "NPD" (No Performance Determined), this can lead to a ban on use in a Member State. Therefore, each member State must establish Product Contact Points, which will provide information on these regulations. In Germany, this is the Federal Institute for Material Research and Testing (BAM: see www.pcp.bam.de).

Assessment procedure

Fasteners which are not covered by a harmonised standard (hEN) can apply for an ETA (European Technical Assessment) on the basis of a European Assessment Document (EAD).

Existing assessment documents, such as ETAGs (European Technical Approval Guidelines) for metal and plastic fixings are still valid and transferred into EADs in accordance with the EU Construction Products Regulation (CRP). The ETAGs and the new EADs can be downloaded from the EOTA website: <http://www.eota.eu>

The assessment document for mechanical fasteners (ETAG 001-1, -2, -3, -4 or in the future, EAD 33-0232) and the assessment document for bonded anchors (ETAG 001-5 or in the future, EAD 33-0499) divides possible approvals of metal fixings into 12 options.

Options 1-6 are for use in cracked and non-cracked concrete, options 7-12 are only for use in non-cracked concrete. Anchors of Option 1 offer the largest range of flexibility for assessment, since performance values for concrete of the strength classes C20/25 to C50/60, as well as the minimum spacing and edge distances are available (see table below).

Section 6 of the ETAG 001 (in the future, EAD 33-0747) regulates the assessment of metal fixings in cracked and non-cracked concrete for multiple use for non-structural systems. Non-load bearing systems include components which do not contribute to the stability of the construction, they only transmit their dead or wind load. These are, for instance, simple suspended ceilings and false ceilings, pipelines and façade claddings.

When using fixings for multiple use, it is assumed that if excessive slippage or failure of a fixing point occurs, that the load will be transferred to neighbouring fixing point. A fixing point can be defined as a single anchor or a group of anchors.

This is known as a redundant system, where stability is not affected by an individual anchor failure.

Possible assessment options according to EAD

Options	Cracked concrete	Non-cracked concrete	One value for all concrete strengths	Different values for C20/25 to C50/60	One value for load direction	Separate values for tensile and shear capacity	c_{cr} / s_{cr}	$c_{min} < c_{cr}$ / $s_{min} < s_{cr}$	Design method as per EN 1992-4
1	✓	x	x	✓	x	✓	✓	✓	A
2			✓	x					
3			x	✓	✓	x			B
4			✓	x					
5			x	✓					C
6			✓	x					
7	x	✓	x	✓	x	✓	✓	✓	A
8			✓	x					
9			x	✓	✓	x			B
10			✓	x					
11			x	✓					C
12			✓	x					

Design of fastenings

Two different anchor designs are differentiated.

Method with global safety factors

Permissible loads are determined from the average failure load or from the 5% fractile load and compared with the action load.

The safety factor depends on the anchoring system, the type of installation and external influences such as temperature and or humidity. Global safety factors are generally $\gamma = 3$ for steel and bonded anchors and $\gamma = 5$ for plastic anchors.

Methods with partial safety factors

According to this method, it is shown that the value of the design actions S_d does not exceed the value of the design resistance R_d ($S_d \leq R_d$).

The action on fixings are determined according to the same rules and used the same partial safety factors employed in reinforced concrete design (see Eurocode 1990; national appendix must be observed).

The design resistance is determined by using the characteristic resistance and the partial safety factor of the material (γ_M), which takes into account the scatter of the material. The values can be taken directly from the ETA. Safety is national law. The design method as well as the related partial safety factors are determined by the Member State.

Only the product-specific coefficient for installation is specified in the ETA, which is used to calculate the partial factor γ_M . The design standard EN 1992-4, which is expected to be ratified in 2018, contains the national determined partial safety factors (observe the respective national appendix).

The design method as set down according to ETAG 001, Annex C - design method for metal anchors and the design method according to TRO29 - bonded anchor design in concrete, as well as CEN/TS 1992-4, Section 4 (mechanical anchors) and Section 5 (chemical anchors) are the current methods for anchor design based on a European Technical Approval or Assessment (ETA). Moreover, the ETAG 001 Annex C distinguishes between three different design methods (A, B and C), method A being the most important and the most economical method since anchors are considered separately for all load directions and failure modes. Methods B and C play a minor role and are hardly used.

Other important design provisions are:

EOTA TR020

Anchor design in concrete under fire exposure, or CEN/TS 1992-4, Part 1, Appendix D

EOTA TR045

Anchor design in concrete for seismic actions

The applicable assessment design methods are generally indicated in the respective ETA. It is important that design methods are not commingled.

The design for metal anchor (under static and seismic loads as well as under fire exposure) is summarised in EN 1992-4, i.e. in Section 4 of the Eurocode 2, but then must be ratified by each Member State and, if applicable, adapted for national annexes. As soon as EN 1992-4 is published, all other design methods (ETAG 001 Annex C, TR045, TR020, TR029 and CEN/TS 1992-4) are no longer valid.

fischer has developed a simple yet powerful design software for daily use: the fischer - C-FIX. The software enables designers and users to carry out anchor designs according to different design methods. Complex anchor arrangements can be calculated quickly and easily. The feature "multiple design" makes it possible to select the best technical and cost saving solution.

Approvals, markings and their importance

The most important symbols are presented below.

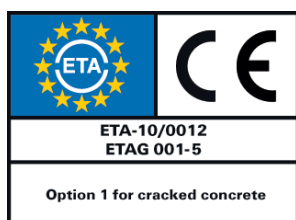

European Technical Approval / Assessment

Issued by a European approval authority (e. g. DIBt) on the basis of the guidelines for European technical approvals (ETAG). ETA (English): European Technical Approval/Assessment. CE: The CE marks the conformity of the product to all applicable legal provisions in which their installation is intended. This means that the CE mark only certifies that the requirements determined in the relevant harmonisation legal provisions of the union have been complied with. Products with the CE mark can be freely traded in the European Economic Market.



ICC International Code Council

ICC Evaluation Service Inc. (ICC ES) issues reports, e. g. for subsequent anchoring on the basis of the International Building Code® and the related standards in the United States of America



FM Certificate

Recognised for use in local water-based fire extinguisher systems (Factory Mutual Research Corporation for Property Conservation, American insurance company).



General building authority approval

German approval, issued by the DIBt, Berlin with the accompanying certificate of conformity for construction products with the general building authority approval. Confirmed by a material testing institute.



Fire-tested fixing

The anchor was subjected to a fire test. It is an "investigation report to test the anchor under fire exposure (fire behaviour) (with R-Class). Fire tests are not required when using the simplified verification method according to TRO20 - then the values can be transferred directly to the ETA.



This product is made from **high corrosion resistant steel** of corrosion resistance class V, e. g. 1.4529.

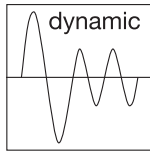

Dynamically loadable anchors

The anchor is suitable and approved for anchoring of “not predominantly static” (i.e. dynamic) loads.static” (i.e. dynamic) loads. static” (i.e. dynamic) loads.



General construction-related test certificate



The fixing is suitable for anchoring under **seismic influence**. Please note: The ICC-ESRs also allow seismic stress (see Category C 1 and C 2 in accordance with the ETAG 001 Annex E).

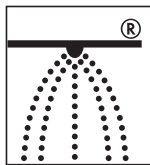

Mark for labels that confirm compliance with the VDS-CEA guidelines for **sprinkler systems, planning and installation**. Fixings labelled as such may be used for fixing pipes for extinguishing systems.



Tested for **flammability** in accordance with VDE.

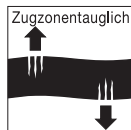

Fixings for tensile zones

The fixing is suitable and approved for anchoring in cracked concrete (tensile zone) and in uncracked concrete (compression zone).



Fixing made of high-quality, ageing-resistant **nylon** (polyamide).



Component test with window frame screws in accordance with ift guideline MO-01/1; Testing structural connections on windows.

The term “approvals” used in the catalogue consists of documents that are available and can be used as evidence of the usability of building products for which the documents were issued. These are (fire) reports, general construction-related approvals issued by the German Institute for Construction Technology Berlin (e.g. Z-2 1...) or European Technical Approvals or Assessments (ETA). In general, the usability of construction products in an EU Member State is

given, if the performance of the significant characteristics required in each Member State has been clarified/ confirmed by the manufacturer. Information on the significant necessary characteristics in a country can be found at the national Product Information Contact (Link: http://ec.europa.eu/Docs_Room/documents/4170/attachments/1/translations/en/renditions/native).

Our service to you

„We are a reliable partner, one that will stand at your side and address your individual requirements with advice and action.“

By implementing the fischer process system (fPS) we offer you the quickest and most efficient service.



Global presence with the fischer international sales team

- One-on-one assistance from multi lingual staff.
- Immediate information and individual solutions regarding the widest range of fixings and fasteners worldwide.
- 46 own subsidiaries and distribution to more than 100 countries worldwide.
- Visit organization A-Z and training programs.

✉ Please contact: export@fischer.de



16

Service



Qualified technical consulting from the fischer technical team

- Support for engineers, consultants and craftsmen.
- More than 130 engineers worldwide give legally compliant technical advice and product recommendations.
- Services include test installations, pull-out tests, individual designs and comparative calculations.
- Special solutions in the scope of fixing technology.

✉ Please contact: anwendungstechnik@fischer.de



Competence and innovation through own research, development and production

- Market research of trends and customer requirements.
- Own research and development teams for chemical, steel and plastic fastenings.
- In-house tool making, special machine construction and production facilities for total process control.
- fischer Process System (FPS) ensures innovative and high quality products.



Wide range of fastening and supplementary products for professional and DIY customers

- Comprehensive assortment of chemical, steel and plastic fastenings.
- Supplementary ranges of installation systems, construction chemicals, wood screws, drill bits, facade systems etc.
- Broadest coverage of applications.
- Standard products, project-based solutions and customer-specific developments.



🔍 Discover our product range:
www.fischer.com/products





16

Service



📍 You can find more details on:
www.fischer.de/Seminare

Professional training sessions in the fischer academy

- Wide range of seminars for craftsmen, engineers and specialist dealers.
- Fixing technology at its best based on over 30 years of training experience.
- Theoretical knowledge and practical exercises in line with the demands of the approval.
- Full service programme in modern training rooms, including accomodation.

FIXPERIENCE design and construction software for demanding applications

- Design software for planners and structural engineers.
- Modular program including engineering software and application modules.
- Based on international design standards (ETAG 001, EC1, EC2, EC3, EC5), including national application documents.
- Free choice of all common power and measurement units.
- Graphical representation in 3D, 2D, move, 360° rotate, pan, tilt, zoom.



📄 Download your free software from:
www.fischer.com/fixperience

Main Catalogue Installation Systems

All facts about the fischer installation systems and their applications.

- Presentation of products and systems with detailed technical data and illustrations.
- Anchors suitable to fix installation system components.
- Application support.
- Basic knowledge of installation systems.
- Available design software.

📞 Order now: info@fischer.com

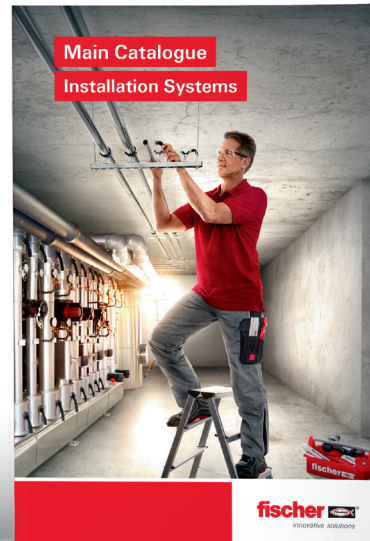

Main Catalogue Screws

All facts about the fischer screw range and their applications.

- Presentation of products with detailed technical data and illustrations.
- Load tables for construction screws.
- Application support.
- Basic knowledge about connections with screws.
- Available design software.

📞 Order now: info@fischer.com

International FireStop Handbook

All facts about the fischer FireStop systems and their applications.

- Presentation of products and systems with detailed technical data and accordance to relevant international standards.
- Anchors suitable to fix sprinkler systems.
- Application support.
- Basic knowledge about active and passive fire prevention as well as air and acoustic sealing systems.

📞 Order now: info@fischer.com



Germany

fischer Deutschland Vertriebs GmbH
Klaus-Fischer-Straße 1
72178 Waldachtal
Tel.: +49 7443 12 6000
Fax.: +49 7443 12 4500
E-Mail: info@fischer.de
http://www.fischer.de

Argentina

fischer Argentina s.a.
Armenia 3044
1605 Munro Ra-PCIA Buenos Aires
Tel.: +54 1147 62 27 78
Fax.: +54 1147 56 13 11
E-Mail: asistenciatecnica@fischer.com.ar
http://www.fischer.com.ar

Austria

fischer Austria GmbH
Wiener Straße 95
2514 Traiskirchen
Tel.: +43 2252 53730 0
Fax.: +43 2252 53730 70
E-Mail: office@fischer.at
http://www.fischer.at

Belgium

fischer Cobemabel snc
Schallénhoevendreef 20 D
2800 Mechelen
Tel.: +32 152 8 47 00
Fax.: +32 152 8 47 10
E-Mail: info@fischer.be
http://www.fischer.be

Brazil

fischer brasil Industria e Comercio Ltda.
Estrada do Dende, 300 Ilha do Governador
21920-001 Rio de Janeiro-RJ
Tel.: +55 21 2467 1130
Fax.: +55 21 2467 0144
E-Mail: fischer@fischerbrasil.com.br
http://www.fischerbrasil.com.br

China

fischer (Taicang) fixings Co. Ltd.
Shanghai Rep. Office Rm 1503-1504, No. 63 Chifeng Road
200092 Shanghai
Tel.: +86 021 65975388
Fax.: +86 021 65979622
E-Mail: ficnsh@fischer.com.cn
http://www.fischer.com.cn

China

fischer (Taicang) fixings Co. Ltd.
Building 1, No.105 North Dongcang Rd.
215400 Taicang Jiangsu
Tel.: +86 512 53 58 89 38
Fax.: +86 512 53 58 89 48
E-Mail: ficn@fischer.com.cn
http://www.fischer.com.cn

Czech Republic

fischer international s.r.o.
Průmyslová 1833
25001 Brandýs nad Labem
Tel.: +42 03 26 90 46 01
Fax.: +42 03 26 90 46 00
E-Mail: info@fischer-cz.cz
http://www.fischer-cz.cz

Denmark

fischer a/s
Sandvadsvej 17 A
4600 Køge
Tel.: +45 46 32 02 20
Fax.: +45 46 32 50 52
E-Mail: fidk@fischerdenmark.dk
http://www.fischerdenmark.dk

Finland

fischer Finland Oy
Suomalaistentie 7 B
02270 Espoo
Tel.: +358 20 7414660
Fax.: +358 20 7414669
E-Mail: orders@fischerfinland.fi
http://www.fischerfinland.fi

France

fischer S. A. S.
12, rue Livio, P.O. Box 10182
67022 Strasbourg-Cedex 1
Tel.: +33 388 39 18 67
Fax.: +33 388 39 80 44
E-Mail: info@fischer.fr
http://www.fischer.fr

Greece

fischer Hellas Emporiki EPE
Nat. Road Athens-Lamia (17th) Gamp; Roupef 6
Kifissia Athens
Tel.: +30 210 2838167
Fax.: +30 210 2838169
E-Mail: info@fischer.gr
http://www.fischer.gr

Hungary

fischer Hungária Bt.
Szerémi út 7/b
1117 Budapest
Tel.: +36 1 347 97 55
Fax.: +36 1 347 97 66
E-Mail: info@fischerhungary.hu
http://www.fischerhungary.hu

India

fischer BUILDING MATERIAL INDIA PVT LTD.
PRESTIGE GARNET UNIT NO- 401, 4TH FLOOR 36, ULSOOR
ROAD
560042 Bangalore KARNATAKA
Tel.: +91 08041511991 92 93
Fax.: +91 08041511989
E-Mail: info@fischer.in
http://www.fischer.in

Italy

fischer italia S.R.L.
Corso Stati Uniti, 25, Casella Postale 391
35127 Padova Z.I. Sud
Tel.: +39 049 8 06 31 11
Fax.: +39 049 8 06 34 01
E-Mail: sercli@fischeritalia.it
http://www.fischeritalia.it

Japan

fischer Japan K.K.
Seishin Kudan Building 3rd Floor 3-4-15 Kudan Minami
Chiyoda-ku
102-0074 Tokyo
Tel.: +81 3 3263 4491
Fax.: +81 3 6272 9935
E-Mail: info@fischerjapan.co.jp
http://www.fischerjapan.co.jp

Korea, Republic of

fischer Korea Co., Ltd
B-903, #131, Kasan Digital-1Ro, Geumcheon-Gu
153-803 Seoul
Tel.: +82 1544 8955
Fax.: +82 1544 8903
E-Mail: info@fischerkorea.com
http://www.fischerkorea.com

Mexico

fischer Sistemas de Fijación, S.A. de C.V.
Blvd. Manuel Avila Camacho 3130-400B
54020 Col. Valle Dorado, Tlalhepantla
Tel.: +52 55 55 72 08 83
Fax.: +52 55 55 72 15 90
E-Mail: info@fischermex.com.mx
http://www.fischermex.com.mx

Netherlands

fischer Benelux B.V.
Amsterdamsestraatweg 45 B/C
1411 AX Naarden
Tel.: +31 35 6 95 66 66
Fax.: +31 35 6 95 66 99
E-Mail: info@fischer.nl
http://www.fischer.nl

Norway

fischer Norge AS
Oluf Onsumsvei 9
0680 Oslo
Tel.: +47 23 24 27 10
Fax.: +47 23 24 27 13
E-Mail: ordre@fischernorge.no
http://www.fischernorge.no/

Philippines

fischer PH Asia, Inc.
No 100 Congressional Avenue, Project 8
1106 Quezon City
Tel.: +63 2426 / 0888 217
Fax.: +63 28803256
E-Mail: joselito.ladlad@fischerph.com
http://www.fischer.ph

Poland

fischerpolska Sp.z o.o
ul. Albatrosow 2
30-716 Kraków
Tel.: +48 12 2 90 08 80
Fax.: +48 12 2 90 08 88
E-Mail: info@fischerpolska.pl
http://www.fischerpolska.pl

Portugal

fischerwerke Portugal, Lda.
Av. Casal da Serra Nº 7, R/C
2625-085 Póvoa de Santa Iria
Tel.: +351 21 953 74 50
Fax.: +351 21 959 13 90
E-Mail: fischerportugal.info@fischer.es
http://www.fischer.pt

Romania

fischer fixings Romania S.R.L.
Calea Baciului Nr. 179
Cluj-Napoca
Tel.: +40 264 455 166
Fax.: +40 264 403 060
E-Mail: office@fischer.com.ro
https://www.fischer.com.ro

Russian Federation

000 fischer Befestigungssysteme Rus
Leningradskoe shosse, 47, Bldg. 2, 2nd floor, apt. VI
125195 Moscow
Tel.: +7 495 223 03 34
Fax.: +7 495 223 03 34
E-Mail: info@fischerfixings.ru
http://www.fischerfixings.ru

Singapore

fischer systems Asia Pte. Ltd.
4 Kaki Bukit Avenue 1, #01-06
417939, Singapore
Tel.: +65 6741 0480
Fax.: +65 6741 0481
E-Mail: sales@fischer.sg
http://www.fischer.sg

Slovakia

fischer S.K. s.r.o.
Nová Rožňavská 134 A
831 04 Bratislava
Tel.: +421 2 4920 6046
Fax.: +421 2 4920 6044
E-Mail: info@fischerwerke.sk
http://www.fischer-sk.sk

Spain

fischer Ibérica S.A.U.
Klaus Fischer 1
43300 Mont-Roig del Camp Tarragona
Tel.: +34 977 83 87 11
Fax.: +34 977 83 87 70
E-Mail: servicio.cliente@fischer.es
http://www.fischer.es

Turkey

fischer Metal Sanayi Ve Ticaret Ltd Sti
Cevizli Mahallesi, Mustafa Kemal Paşa Cad. Seyit Gazi Sok.
No 66, Hukukcular Towers A Blok
34865 Kartal İstanbul
Tel.: +90 216 326 0066
Fax.: +90 216 326 0018
E-Mail: info@fischer.com.tr
http://www.fischer.com.tr

United Arab Emirates

fischer FZE
R/A 07, BA - 04, Jebel Ali Free Zone
Dubai
Tel.: +97 14 8 83 74 77
Fax.: +97 14 8 83 74 76
E-Mail: enquiry@fischer.ae
http://www.fischer.ae

Sweden

fischer Sverige AB
Tennngatan 4
602 23 Norrköping
Tel.: +46 11 31 44 52
Fax.: +46 11 33 1950
E-Mail: gg@fischersverige.se
http://www.fischersverige.se

United Kingdom

fischer fixings UK Ltd.
Whitely Road
Oxon OX10 9AT Wallingford
Tel.: +44 1491 82 79 00
Fax.: +44 1491 82 79 53
E-Mail: info@fischer.co.uk
http://www.fischer.co.uk

United States

fischer fixings LLC
1084 Doris Rd
48326 Auburn Hills, MI
Tel.: +1 973 256 3045
Fax.: +1 845 625 2666
E-Mail: sales@fischerus.net
http://fischerfixings.com

Albania

fischer Austria GmbH
Wiener Straße 95
2514 Traiskirchen
Tel.: +43 2252 53730 0
Fax.: +43 2252 53730 70
E-Mail: office@fischer.at
http://www.fischer.at

Algeria

Siestal Sarl
Zone Industrielle
0600 Bejaia
Tel.: +34 21 26 58
Fax.: +34 20 15 69
E-Mail: marketing-mac@siestal-dz.com

Angola

O-INDEX TRADING LDA.
Rua Comandante Hoji-Ya-Henda (Ex Avenida Brazil) Edifício o-index Nº31, Município de Rangel Luanda-Angola
Tel.: +244 222 383 421
Fax.: +244 222 383 721
E-Mail: info@o-index.com
www.o-index.com

C. Woermann Angola, Lda.

Km 4.5 Estrada de Cacuaço
Bairro Patrangol, LUANDA
Tel.: +244 227 270 185
E-Mail: c.poetsch@woermann-angola.com
http://www.c-woermann.com

Ovarmat Angola

Rua A, Quarteirão I, N.º 11, Bairro 1.º de Maio
Viana / LUANDA
Tel.: +244 921 180 132
Fax.: +244 926 405 833
E-Mail: ovarmatangola@gmail.com

Armenia

Kasco Ltd.
Yervand Kochar str. 3-1 a
0070 Yervand
Tel.: +374 10 57 55 00

Australia

Anchormark Pty.Ltd
61 Waterview Close Unit 1
VIC 3175 Dandenong South, Victoria
Tel.: +61 (0) 3 97992096
Fax.: +61 (0) 3 97992696
E-Mail: marcus@anchormark.com.au
http://www.anchormark.com.au

Azerbaijan

Santral Elektrik MMC
Boyuk Shor highway 11/2062
1029 Baku
Tel.: +994 125144048
Fax.: +994 125144046
E-Mail: elchin@santral.az

Bahrain

M.H. Al Mahroos BSC (c)
Building No. 208, Shaikh Salman Highway, P.O. Box 65
Salhiya, Block 356, Manama
Tel.: +973 17 40 80 90
Fax.: +973 17 40 43 23
E-Mail: almahroos@almahroos.com
http://www.almahroos.com

Bangladesh

Abedin Equipment Limited
B 52 Kemal Ataturk Avenue
1213 Banani, Dhaka
Tel.: +880 298 808 60
Fax.: +880 29862340
E-Mail: gk@accl.group-qa.com
http://www.abedin-equipment.com

Barbados

Maxwell Trading Inc
Salters Warehouse Complex
Salters, St George
Tel.: +246 4293731
Fax.: +246 4293731
E-Mail: maxwelltrading@caribsurf.com

Belarus

MetallArtStory
industrial area „zaozerye-1“
223141 d.Saoser`je, Logoyskij r-n, Minskaja obl.
Tel.: +375 172684567
E-Mail: metallartstroy@mail.ru

Bolivia

NAUVOO IMPORTADORES
Calle Isaac Tamayo Nº 840, Complejo Virgen del Rosario,
Bloque B, Local 04, zona Rosario
10392 La Paz
Tel.: +59122453782

WAKO IMPORTAC.Y REPRESENTAC.

Av. Pedro Rivera #3550 Tercer Anillo Interno
531 SANTA CRUZ DE LA SIERRA
Tel.: +1578282012

Bosnia and Herzegovina

fischer Austria GmbH
Wiener Straße 95
2514 Traiskirchen
Tel.: +43 2252 53730 0
Fax.: +43 2252 53730 70
E-Mail: office@fischer.at
http://www.fischer.at

Bulgaria

fischer Austria GmbH
Wiener Straße 95
2514 Traiskirchen
Tel.: +43 2252 53730 0
Fax.: +43 2252 53730 70
E-Mail: office@fischer.at
http://www.fischer.at

Cameroon

fischer S. A. S.
12, rue Livio, P.O. Box 10182
67022 Strasbourg-Cedex 1
Tel.: +33 388 39 18 67
Fax.: +33 388 39 80 44
E-Mail: info@fischer.fr
http://www.fischer.fr

Canada

Canadian Fasteners Hegedus Ltd.
1180 Quest. De Louvain West
HAN 1G5 Quebec, Montréal
Tel.: +1 514 3 81 34 31
Fax.: +1 514 3 81 36 88
E-Mail: braccine@ancragescanadiens.com
http://www.ancragescanadiens.com

Wm. P. Somerville Ltd.

3964 Kitchener Street
BC V5C 3M2 Burnaby
Tel.: +1 604 298 36 22
Fax.: +1 604 298 59 26
E-Mail: wmp1996@telus.net

Chile

American Screw de Chile Ltda.
Cno. A Melipilla 10338-C.1844
8320000 Santiago
Tel.: +56 2440 7000

Colombia

Ingenier.Y Representaciones Sa
Calle 41 Norte Nro.1N-03
760003 Cali
Tel.: +572 3194020 4482521

Costa Rica

Distribuidora Arsa S.A.
Guadalupe, de Clinica Jerusalem 400 Este y 75 Sur
2110-2100 San Jose
Tel.: +506 2854224

Industria Ceramica Costarricense S.A.

1.5 Km Oeste de Aviacion Civil, La Uruca
San Jose
Tel.: +506 25195433
Fax.: +506 22914501
E-Mail: Marietta.melendez@inccasstd.com
http://www.americanstandardca.com

TORCASA (TORNILLOS CENTROAMERICANOS S.A.)

Av #10 entre calles #14 & #16
13955-1000 San Jose
Tel.: +50625393939

Côte d'Ivoire

fischer S. A. S.
12, rue Livio, P.O. Box 10182
67022 Strasbourg-Cedex 1
Tel.: +33 388 39 18 67
Fax.: +33 388 39 80 44
E-Mail: info@fischer.fr
http://www.fischer.fr

Croatia

fischer Austria GmbH
Wiener Straße 95
2514 Traiskirchen
Tel.: +385 16 235 935
Fax.: +385 16 235 881
E-Mail: office@fischer.at
http://www.fischer.at

Curacao

Caribbean Fasteners Group
Emancipatieboulevard 29
PO BOX6052 Willemstad
Tel.: +599 97376288
E-Mail: purchase@cftg-group.com

Cyprus

Unicol chemicals Ltd
10.P.Demetrakopoulos street, P.O. Box 25606
1090 Nicosia
Tel.: +357 22663316
E-Mail: info@unicolltd.com

Czech Republic

fischer Austria GmbH
Wiener Straße 95
2514 Traiskirchen
Tel.: +43 2252 53730 0
Fax.: +43 2252 53730 70
E-Mail: office@fischer.at
http://www.fischer.at

Ecuador

Pino Aristata Sociedad Anonima
Luis Urdaneta Nr. 1909 y Tulcan
AP.09-04-500 Guayaquil
Tel.: +593 42288000

Egypt

Modern Machines & Materials Co.
23 El Madina El Monawara Street
Gouvernement Al-Qahira
Tel.: +20 2 3 03 02 51
E-Mail: enayatatab@gmail.com

Estonia

fischerpolska Sp.z o.o
ul. Albatrosow 2
30-716 Kraków
Tel.: +370 601 61509
Fax.: +48 12 2 90 08 88
E-Mail: marek.smolencic@fischerpolska.pl
http://www.fischerfixings.ee

Ethiopia

FOREVER Private Limited Company
P.O.Box 4906 Addis Ababa
Tel.: +251 11 1560600
Fax.: +251 11 1560189
E-Mail: foreverplc@ethionet.et

French Polynesia

fischer S. A. S.
12, rue Livio, P.O. Box 10182
67022 Strasbourg-Cedex 1
Tel.: +33 388 39 18 67
Fax.: +33 388 39 80 44
E-Mail: info@fischer.fr
http://www.fischer.fr

Gabon

fischer S. A. S.
12, rue Livio, P.O. Box 10182
67022 Strasbourg-Cedex 1
Tel.: +33 388 39 18 67
Fax.: +33 388 39 80 44
E-Mail: info@fischer.fr
http://www.fischer.fr

Ghana

C. WOERMANN (GHANA) LIMITED
C362/1 Nsawam Road / Avenor Junction
P.O. Box GP 1779 ACCRA
Tel.: +233(0)30222 51 41
Fax.: +233(0)30223 00 16
E-Mail: info@woermann-ghana.com
http://www.woermann-ghana.com

Guadeloupe

fischer S. A. S.
12, rue Livio, P.O. Box 10182
67022 Strasbourg-Cedex 1
Tel.: +33 388 39 18 67
Fax.: +33 388 39 80 44
E-Mail: info@fischer.fr
http://www.fischer.fr

Guatemala

Compañía Comercial e Industrial Electro Diesel de Guatemala, S. A (EDISA)
8A calle 6-62-Zona 4
01004 Guatemala
Tel.: +50 2254940000
E-Mail: daniel.gonzalez@grupomaster.com.gt

Guyana

fischer S. A. S.
12, rue Livio, P.O. Box 10182
67022 Strasbourg-Cedex 1
Tel.: +33 388 39 18 67
Fax.: +33 388 39 80 44
E-Mail: info@fischer.fr
http://www.fischer.fr

Honduras

Importadora Ferrerera S.A
B0 Las Palmas Calle 17 CLL 5-6
San Pedro Sula
Tel.: +504 25541848
Fax.: +504 255453096
E-Mail: dinora.rodriguez@imferra.com
http://imferra.com

Larach & Cia, S. de R.L. de C.V.

1347 Calle de la Salud, Colonia Miramontes
Tegucigalpa M.D.C
E-Mail: precursora1@amnetn.com

Honduras

Industrial Ferrereta, S.A. de C.V.
Calle Principal 401, San Jose del Pedregal
Comayaguella
E-Mail: elopez@indufesa.com
http://www.indufesa.com

Hong Kong

Infix (HK) Ltd.
12 Ka Yip Street; Unit 15, 12/FI. Paramount Building
Chai Wan
Tel.: +852 2898 26 68
Fax.: +852 2898 23 38
E-Mail: barry@infix.com.hk

Iceland

Byko Ltd
Skemmuvegi 2A
200 KOPAVOGUR
Tel.: +354 515 40 00
E-Mail: andres@byko.is
https://www.byko.is/

Iran

Abzarsara Co.
138, Sanai St.
15866 - 45915 Teheran
Tel.: +98 21 888 13 120
E-Mail: alireza.ramzgooyan@abzarsara.com
http://www.abzarsara.com

Indonesia

PT BERSAMA Bangun Persada
Perkantoran Mega Sunter Blok D10-11
14350 Jakarta Utara
Tel.: +62 21 65837575
Fax.: +62 21 65835363
E-Mail: hendrik@mrsafetygroup.com
http://www.mrsafetygroup.com

Iraq

Albasool Co.
Alrasheed Street, New Armin Building No. 81, Shop No. 37
Baghdad
Tel.: +964 79 0192 0322
E-Mail: ahmednory73@yahoo.com

Ireland

Chadwicks Ltd., SaMontec
Naas Road, Ashfield
Dublin 22
Tel.: +353 1419 7500
Fax.: +353 1 4602811
E-Mail: gerry.fitzsimons@gmroi.ie
http://www.chadwicks.ie

Masonry Fixings Services Ltd.

Cherry Orchard Industrial Estate
Dublin 10
Tel.: +353 1 642 6700
Fax.: +353 1 626 3493
E-Mail: bryan@masonryfixings.ie
http://www.masonryfixings.ie/

Israel

Ledico Ltd.
31 Lazarov St.
75654 Rishon LeZiyon
Tel.: +972 3 9630054
Fax.: +972 3963 00 55
E-Mail: santil@ledico.com
http://www.ledico.com

Jordan

Izzat Marji Group
No. 10, Amer Bin Malek st. - Um Sumag, P.O. Box: 1945
11821 Amman
Tel.: +962 655 202 84
E-Mail: mohd.taha@marji.jo
http://www.marji.jo

Kazakhstan

fischerpolska Sp.z o.o
ul. Albatrosow 2
30-716 Kraków
Tel.: +48 605 106 657
Fax.: +48 12 2 90 08 88
E-Mail: marek.smoleniec@fischerpolska.pl
http://www.fischerpolska.pl

Kenya

THORN ELECTRICALS LIMITED
00100 GPO Nairobi
Tel.: +254708504111
Fax.: +254733734444
E-Mail: info@thornpower.co.ke
http://www.thornpower.co.ke

THORN POWER

GPO
00100 Nairobi
Tel.: +254708504111
Fax.: +254733734444
E-Mail: chirag.amin@thornpower.co.ke

Kosovo

fischer Austria GmbH
Wiener Straße 95
2514 Traiskirchen
Tel.: +43 2252 53730 0
Fax.: +43 2252 53730 70
E-Mail: office@fischer.at
http://www.fischer.at

Kuwait

M/S Safina Al Najjat Co.
Shuwaikh - Khalifa Jassim Street P.O. Box 20329
13064 Safat
Tel.: +965 2481 8786
Fax.: +965 2481 8385
E-Mail: bhagat@safinanajjat.com

Latvia

fischerpolska Sp.z o.o
ul. Albatrosow 2
30-716 Kraków
Tel.: +370 601 61509
Fax.: +48 12 2 90 08 88
E-Mail: marek.smoleniec@fischerpolska.pl
http://www.fischerfixings.lv

Liberia

Beever Company Inc.
U.N. Drive, Vai Town
Monrovia
Tel.: +231 - 886511112
E-Mail: info@beever.com/
http://www.beever.com/

Lithuania

fischerpolska Sp.z o.o
ul. Albatrosow 2
30-716 Kraków
Tel.: +370 601 61509
Fax.: +48 12 2 90 08 88
E-Mail: marek.smoleniec@fischerpolska.pl
http://www.fischerfixings.lt

Luxembourg

Hilger Interfer S.A.
36-37, z.a.e. Triangle Vert
5691 Ellange
Tel.: +352 48 48 15 1
Fax.: +352 48 48 15 350
E-Mail: info@hilger.lu
http://www.hilger.lu

Macedonia

fischer Austria GmbH
Wiener Straße 95
2514 Traiskirchen
Tel.: +43 2252 53730 0
Fax.: +43 2252 53730 70
E-Mail: office@fischer.at
http://www.fischer.at

Madagascar

fischer S. A. S.
12, rue Livio, P. O. Box 10182
67022 Strasbourg-Cedex 1
Tel.: +33 388 39 18 67
Fax.: +33 388 39 80 44
E-Mail: info@fischer.fr
http://www.fischer.fr

Malaysia

Defix Concrete Products Sdn Bhd
No 8, Jalan PJS 5/26, Taman Desaria, PJS 5, Petaling Jaya
46000 Kuala Lumpur
Tel.: +60 16 893 3796
E-Mail: info@defixcp.com.my
https://defixcp.com.my

Maldives

M/S Sonee Hardware, Sonee Building
Sonee Building, 181 BoduthakuruFaanu Magu
20181 Male'
Tel.: +960 333 6699
Fax.: +960 332 0304
E-Mail: ahmed.alam@sonee.com.mv
http://www.sonee.com.mv

Malta

Tessera
Dockyard Street
PLA 2115 Paola
Tel.: +356 99426724
Fax.: +356 27490100

Martinique

fischer S. A. S.
12, rue Livio, P. O. Box 10182
67022 Strasbourg-Cedex 1
Tel.: +33 388 39 18 67
Fax.: +33 388 39 80 44
E-Mail: info@fischer.fr
http://www.fischer.fr

Mauritius

DEMA-SUPPLIES LTD
2A Deschartes Street
Port Louis
Tel.: +230 2126405
Fax.: +230 2107457
E-Mail: dema@intnet.mu

Mayotte

fischer S. A. S.
12, rue Livio, P. O. Box 10182
67022 Strasbourg-Cedex 1
Tel.: +33 388 39 18 67
Fax.: +33 388 39 80 44
E-Mail: info@fischer.fr
http://www.fischer.fr

Monaco

fischer S. A. S.
12, rue Livio, P. O. Box 10182
67022 Strasbourg-Cedex 1
Tel.: +33 388 39 18 67
Fax.: +33 388 39 80 44
E-Mail: info@fischer.fr
http://www.fischer.fr

Montenegro

fischer Austria GmbH
Wiener Straße 95
2514 Traiskirchen
Tel.: +43 2252 53730 0
Fax.: +43 2252 53730 70
E-Mail: office@fischer.at
http://www.fischer.at

Morocco

Outipro
53, Rue du Lieutenant Mohamed Mahroud
Casablanca
Tel.: +2122 2 24 77 21
Fax.: +2122 2 40 82 34
E-Mail: ajana.zineb@outipro.ma

Mozambique

Nova Vida Lda
Rua Paulino Santos Gil 94
Maputo
Tel.: +258 21 327370
Fax.: +258 21 327371
E-Mail: info@novavida.co.mz

Myanmar

TIGER SUPPLY CO., LTD
19/21 Station Roadk Bauk Htwaw
YANKIN TOWNSHIP, YANGON
Tel.: 01-400411
Fax.: 01-430559
E-Mail: tigeryangon@gmail.com

Namibia

CE Paulus t/a Werner Behnsen Enterprises
PO Box 6302, Ausspannplatz 8 Kalie Roodt Street Northern
Industrial
Windhoek
Tel.: +264 61234234
Fax.: +264 61225353
E-Mail: wrb@iafrica.com.na

Nepal

Water Light Center / Watt&Volt House
Kha 2/65, Dillibazar, P.O. Box No: 2108
Kathmandu
Tel.: +977 1 441 1330
E-Mail: watt@ntc.net.np
http://www.facebook.com/wattandvolthouse

New Caledonia

fischer S. A. S.
12, rue Livio, P. O. Box 10182
67022 Strasbourg-Cedex 1
Tel.: +33 388 39 18 67
Fax.: +33 388 39 80 44
E-Mail: info@fischer.fr
http://www.fischer.fr

New Zealand

Anchormark Pty.Ltd
61 Waterview Close Unit 1
VIC 3175 Dandenong South, Victoria
Tel.: +61 (0) 3 97992096
Fax.: +61 (0) 3 97992696
E-Mail: marcus@anchormark.com.au
http://www.anchormark.com.au

Nigeria

C.Woermann (Nigeria) Ltd.
6, Badojo Kalesanwo Street
Matori Industrial Estate Lagos
Tel.: +234 (0) 17 73 64 98
E-Mail: info@woermann-nigeria.com
http://www.woermann-nigeria.com

Oman

Technical Supplies International Co LLC
Al Athaibah, Sultanate of Oman, Post Box 1827
130 Wadi al Kabir
Tel.: +968 2450 39 15
Fax.: +968 2450 39 20
E-Mail: venugopal@tecsintl.com
http://www.tecsintl.com

Pakistan

H.S.AHMEDDALLY
Plot 14/A/1, Block-6, PECHS
Shara-e-Faisal, Adjacent KFC Nursery Karachi
Tel.: +92 21 34548345 47
Fax.: +92 21 34548348
E-Mail: shghazanfar@hsahmeddaily.com

Paraguay

PETERSEN INDUSTRIA & HOGAR S.A

Santo Tomas #1653 C/ Avda. Artigas
1645 Asuncion
Tel.: +59521206131

Reunion

fischer S. A. S.

12, rue Livio, P. O. Box 10182
67022 Strasbourg Cedex 1
Tel.: +33 388 39 18 67
Fax.: +33 388 39 80 44
E-Mail: info@fischer.fr
http://www.fischer.fr

Russian Federation

Inform Ltd

Suvorova 125-A
236028 Kaliningrad
Tel.: +7 65 11 00
Fax.: +7 65 11 00
E-Mail: inform@inform.koenig.ru
http://www.inform-expert.ru

Rwanda

Maltexx Ltd.

KG 15th av.
Plot 808 Kacyiru- Kigali
Tel.: +250 788 411 422
E-Mail: info@maltexx.com

Saint Pierre and Miquelon

fischer S. A. S.

12, rue Livio, P. O. Box 10182
67022 Strasbourg Cedex 1
Tel.: +33 388 39 18 67
Fax.: +33 388 39 80 44
E-Mail: info@fischer.fr
http://www.fischer.fr

Saudi Arabia

Juffali Technical Equipment Company (JTECO)

Kilo 6, Medimah Road
21431 Jeddah
Tel.: +966 2 66 72 222
Fax.: +966 2 66 76 308
E-Mail: roland@ejab.com.sa
http://www.ejab.com

Senegal

fischer S. A. S.

12, rue Livio, P. O. Box 10182
67022 Strasbourg Cedex 1
Tel.: +33 388 39 18 67
Fax.: +33 388 39 80 44
E-Mail: info@fischer.fr
http://www.fischer.fr

Groel

AMITIE III VILLA N°4436
22788 Dakar-Ponty
Tel.: (221)33 825 39 48
Fax.: (221)33 825 39 47
E-Mail: groel@groel.sn
http://www.groel.sn

Sierra Leone

Eugene Ilono Enterprises

56 Lower Bombay Street
FREETOWN
Tel.: +232 33445630
E-Mail: eugeneilono@gmail.com

Slovenia

fischer Austria GmbH

Wiener Straße 95
2514 Traiskirchen
Tel.: +43 2252 53730 0
Fax.: +43 2252 53730 70
E-Mail: office@fischer.at
http://www.fischer.at

South Africa

Upat S.A. (Pty.) Ltd.

1st Floor Lekrom House, Cnr. Miller & 3rd Streets
2094 New Doornfontein Johannesburg
Tel.: +27 11 6 24 67 15
Fax.: +27 11 6 24 67 60
E-Mail: ideas@upat.co.za
http://www.upat.co.za

Sri Lanka

Diesel & Motor Engineering PLC

65 Jetawana Road P.O. Box 339
Colombo - 14
Tel.: +94 112 449 797
Fax.: +94 2449080
E-Mail: kumar.rodrigo@dimolanka.com
http://www.dimolanka.com

Swaziland

Tech-Tool 2000 (Pty) Ltd.

Plot 628, 5th Avenue
Matsapha
Tel.: +268 25186621
Fax.: +268 25186411
E-Mail: sales@techtool.co.sz

Switzerland

SFS unimarket AG Befestigungstechnik

Rosenbergastrasse 4
CH-9435 Heerbrugg
Tel.: +41 71 727 52 00
Fax.: +41 71 727 52 19
E-Mail: befestigungstechnik@sfsunimarket.ch
www.sfs.ch

SFS unimarket AG Technique de fixation

Z.I. Champ Cheval 1
CH-1530 Payerne
Tel.: +41 71 8862 865
Fax.: +41 71 8862 860
E-Mail: techniquefixation@sfs.ch
www.sfs.ch

Syrian Arab Republic

Dallal Est.

P.O. Box 8303 Barron Street
Aleppo - Machroutieh
Tel.: +963 21 2116083
E-Mail: rita.dallal@hotmail.com

Taiwan

Perfect Link Co. Ltd.

Siyuan Road
231 Taipei, Sindian City
Tel.: +886 2 22 19 4698
Fax.: +886 2 22 19 9939
E-Mail: harvey@perfectlink.com.tw

Cheng Yi Fixing Co. Ltd.

N04, LN152, Zhongping RD
Taipei City
Tel.: +886 2 8992 2592
Fax.: +886 2 8992 3797
E-Mail: chengyi0800@gmail.com
www.chengyi.com.tw

Fu Hau

Da-An Rd. No. 7
Taipei City, R.O.C.
Tel.: +886 2 2773 5110
Fax.: +886 2 25418008
E-Mail: swapnal@ms61.hinet.net
http://www.ifischer.com.tw

Thailand

fischer Innovative Solutions Co., Ltd.

38,40 Chaleom Prakiat Ratchakan-Thi 9 Road Soi 33
Nongbon, Pravat
10250 Nongbon, Pravat, Bangkok
Tel.: +66 27473752
Fax.: +66 2 7473754
E-Mail: vinai@ssm.in.th

Togo

fischer S. A. S.

12, rue Livio, P. O. Box 10182
67022 Strasbourg Cedex 1
Tel.: +33 388 39 18 67
Fax.: +33 388 39 80 44
E-Mail: info@fischer.fr
http://www.fischer.fr

Tunisia

TEG Tunisienne Équipement General

AV. Hédi Chaker, 43
1002 Tunis
E-Mail: fathia@tegnegoce.com

Turkey

fischer Metal Sanayi Ve Ticaret Ltd Sti

Cevizli Mahallesi, Mustafa Kemal Paşa Cad. Seyit Gazi Sok.
No 66, Hukukcular Towers A Blok
34865 Kartal İstanbul
Tel.: +90 216 326 0066
Fax.: +90 216 326 0018
E-Mail: info@fischer.com.tr
http://www.fischer.com.tr

Turkmenistan

fischer Metal Sanayi Ve Ticaret Ltd Sti

Cevizli Mahallesi, Mustafa Kemal Paşa Cad. Seyit Gazi Sok.
No 66, Hukukcular Towers A Blok
34865 Kartal İstanbul
Tel.: +90 216 326 0066
Fax.: +90 216 326 0018
E-Mail: info@fischer.com.tr
http://www.fischer.com.tr

Uganda

Maltexx Ltd.

Plot 84-88, 7th street, Industrial area
P.O. BOX 35789 Kampala
Tel.: +256 775 965 389
E-Mail: info@maltexx.com

Ukraine

fischerpolska Sp.z o.o

ul. Albatrosow 2
30-716 Kraków
Tel.: +48 605 106 657
Fax.: +48 12 2 90 08 88
E-Mail: marek.smolencic@fischerpolska.pl
http://www.fischerpolska.pl

United States

HQ Army Air Force

P. O. BOX 660261
75266-0261 Dallas, Tx
Tel.: +1 217 726 5838
Fax.: +1 217 726 5853
E-Mail: marc@weedouthat.org

Uruguay

Juan Goldfarb S.A.

Rio Negro 1617
111000 Montevideo

Landfor S.A.

Itzaingoa Sur Rincon 531 ES302
20000 Zona Franca Florida
Tel.: +598 9161164

Pampin y Cia

Valparaiso 1199
11800 Montevideo
Tel.: +5982 924 0608

Record Tools S.A.

Paysandu 951
111000 Montevideo
Tel.: +5982 902 7492

Venezuela

IMPEX DE VENEZUELA C.A.

Av. Este 1, Galpon 02 Parcela N° 61, Zona Industrial LA
MORITA I
2115 TURMERO-ARAGUA
Tel.: +584402432695019

Vietnam

UNIC JOIN STOCK COMPANY

5-7 Hoang Viet str, Ward 4, Tien Binh Dist, HCMC, Vietnam
Ho Chi Minh City
Tel.: +84 3811 9195/96
Fax.: +84 3811 9197
E-Mail: sales@unic.com.vn

Viet Technology & Development Jsc

Suite 608, Savina Building, 1 Dinh Le, Hoan Kiem, Hanoi.
Hanoi
Tel.: +84 4 3933 4549
Fax.: +84 4 3933 4547
E-Mail: linh.vu@viet-tech.vn
http://www.viet-tech.vn

The information in this catalogue is intended for general guidance only and is given without engagement. Additional information and advice on specific applications is available from our Technical Support Team. For this however, we require a precise description of your particular application.

All the data in this catalogue concerning work with our fixing elements must be adapted to suit local conditions and the type of materials in use. If no detailed performance specifications are given for certain articles and types, please contact our Technical Service Department for advice.

fischerwerke GmbH & Co. KG
72178 Waldachtal
Germany

We cannot be responsible for any errors, and we reserve the right to make technical and range modifications without notice.
No liability is accepted for printing errors and omissions.



Contacts

fischerwerke GmbH & Co. KG
Klaus-Fischer-Straße 1
72178 Waldachtal
Germany

Phone: +49 7443 12-0
Fax: +49 7443 12-4222
E-mail: info@fischer.de
www.fischer.de

fischer fixings UK Ltd.
Whitely Road
Oxon OX10 9AT Wallingford
Great Britain

Phone: +44 1491 827900
Fax: +44 1491 827953
E-mail: info@fischer.co.uk
www.fischer.co.uk

fischer Systems Asia Pte. Ltd.
150 Kampong Ampat
#04-03 KA Centre
Singapore 368324

Phone: +65 62 85 22 07
Fax: +65 62 85 83 10
E-mail: sales@fischer.sg

Your dealer



00088220 · 12/2018 · V-MKS/CPI · Printed in Germany

